

HVAC / R / ASHP PRODUCT GUIDE



#simplifyyoursupply
#thediversitechway

**PUMP
HOUSE**

DIVERSITECH®



Everything you need from our wide range of products to make installation easier



From chemicals through to leak detection dyes, DiversiTech International covers all your needs



If it is in our extensive range of Easy-Fit products (from brackets to protective guards) - it's EASY-to-FIT



A full range of hand tools including BOSCH, Imperial, Spin and Hilmor



Our comprehensive range of products that provide a simplistic and cost-effective mounting solution

- REFRIGERATION
- AIR CONDITIONING
- BOILER & HEATING
- AIR SOURCE HEAT PUMPS
- FLEXI SUPPORT SYSTEMS
- FIXINGS
- OILS & LUBRICANTS
- TOOLS

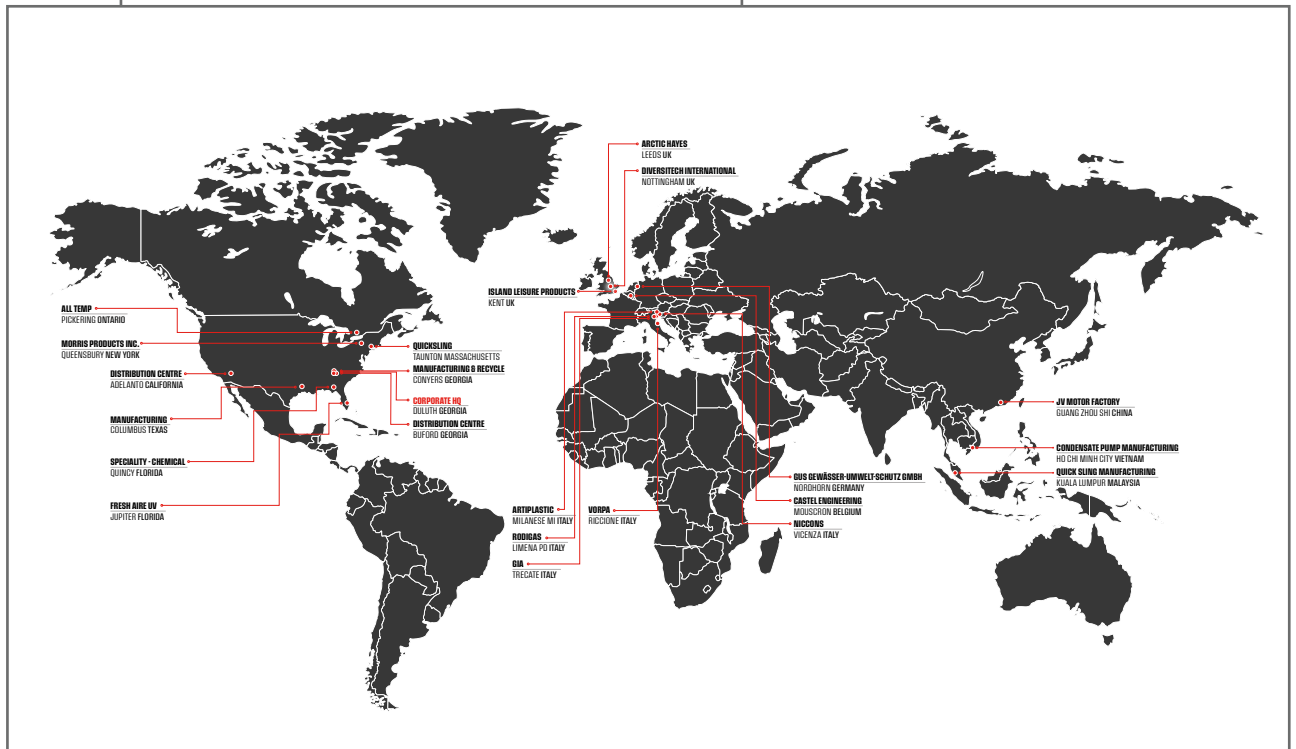

DIVERSITECH INTERNATIONAL

ABOUT US.....	4
WARRANTY.....	236
INDEX (PRODUCT NAME).....	237

REFRIGERATION**5**

PUMPS.....	6
VIBRATION ABSORBER / CLAMP.....	7
FAN MOTORS.....	8
ISOLATORS.....	10
REFRIGERATION OIL [FUCHS].....	11

AIR CONDITIONING**13**

CONDENSATE PUMPS & ACCESSORIES.....	15
HIGH TEMPERATURE PUMPS.....	20
ADAPTORS.....	21
HOSE & CLAMPS.....	22
GUARDS.....	24
BRACKETS.....	25
TRAYS.....	29
TRUNKING.....	30
MOUNTING.....	37
PORTABLES.....	41
CLAMPS & CLIPS.....	43
BRASS & ACCESS FITTINGS.....	48
COPPER FITTINGS.....	50
SERVICE & MAINTENANCE.....	56
TOOLS.....	59
TORCHES.....	61
AUTOMOTIVE.....	63
LUBRICANTS & DYES.....	63
LEAK ARMOR.....	64
RAPID-O FITTINGS.....	65
ACCESSORIES.....	66
LINE PIERCING VALVES & TOOLS.....	69
TAPES, CLOTHS AND MATS.....	73

OTHER PUMPS**73**

INDUSTRIAL PUMPS.....	74
MAGNETIC DRIVE PUMPS.....	75

BOILER & HEATING**77**

BOILER CONDENSATE PUMPS.....	78
CONDENSATE NEUTRALISERS.....	78
HIGH TEMPERATURE & PRESSURE RELIEF PUMPS.....	79
DRAINAGE PUMPS.....	81
SOAKAWAY AND BYPASS VALVE.....	82
CONDENSATE PUMP ACCESSORIES.....	83
PORTABLES.....	84
TORCHES.....	86
TAPE.....	86
SWITCHES & ISOLATORS.....	87
SERVICE & MAINTENANCE.....	87
ACCESSORIES.....	88
PLASTIC PIPE FITTINGS.....	90

AIR SOURCE HEAT PUMPS**93**

INSTALLING.....	94
CONNECTING.....	101
INSULATING.....	101
PROTECTING.....	103
MAINTAINING.....	106
A2L / A3 TOOL KITS.....	107

FLEXI SUPPORT SYSTEMS**109**

FLEXI BASE & EXTENDER FRAMES.....	110
FLEXI H FRAME KITS.....	111
FLEXI FOOT WITH STRUT.....	112
BABY SUMO ADJUSTABLE FOOT.....	112
FLEXI FOOT UNIVERSAL.....	113
FLEXI FOOT VARIATIONS.....	114
FLEXI TWIN FRAMES.....	115
FLEXI QUAD FRAMES.....	116
FLEXI MODULAR FRAMES.....	117
FLEXI CUSTOM FRAMES.....	118
ACCESS (STEP & HOP OVERS).....	119
ACCESS (PLATFORMS & WALLWAYS).....	120

FIXINGS**121**

SLOTTED CHANNEL.....	122
CHANNEL ACCESSORIES.....	124
CABLE TRAYS.....	125
BASKET TRAYS.....	126
WASHERS.....	127

NUTS.....	128
SCREWS.....	129
BOLTS.....	130
CLAMPS & CLIPS.....	132
SWITCHES/ISOLATORS/GLANDS.....	134
CABLES & ACCESSORIES.....	135

OIL & LUBRICANT**137**

VACUUM PUMP OIL.....	139, 170
FUCHS OILS.....	138

TOOLS**145**

RECOVERY MACHINES.....	147
LEAK DETECTION.....	157
SCALES.....	161
VACUUM PUMPS.....	167
HAND TOOLS.....	173
• EXPANDER.....	174
• FLARING & SWAGING.....	175, 183
• TUBING TOOLS.....	176
• TESTING & SERVICE.....	186
• REFRIGERANT CHARGING.....	187
• COUPLERS.....	188
• COIL JET SPRAYER.....	189
• LINE SET BENDER.....	190
MANIFOLDS.....	191
GAUGES & HOSES.....	195
HILMOR RANGE.....	201
• HOSES.....	202
• TUBE BENDER.....	203
• FLARING & SWAGING.....	209
• TUBE CUTTERS.....	212
• COMPACT VACUUM GAUGE.....	216
* DUAL READOUT THERMOMETER.....	217
• SCREWDRIVERS.....	218
• MULTI-TOOLS.....	222
• HEX KEYS.....	224
• WRENCHES.....	225
• PLIERS.....	227
• CRIMPING.....	237
• STRIPPERS.....	239
• DEBURRING.....	232
• UTILITY KNIFE.....	233
• TOOL BAGS.....	234

ABOUT



PRODUCTS

We strive to design, manufacture, stock and deliver to you, our customers, the best products on the market - constantly innovating and improving. Our products are designed to save you time. We are the only company which covers the ancillary range for the HVAC / R / ASHP market.

OUR ETHOS

We aim to be the solution provider for the industry. We aim to listen to our customers, and provide the fastest response time within the industry.

EXPERIENCED STAFF

We understand that each customer's needs are unique. Our team at DiversiTech International respect and consider this in every decision we make. Face-to-face, over the phone or electronically - we are here to serve you. Our sales and technical teams strive for the highest standards.

TECHNICAL EXPERTS

We believe that delivering exceptional technical support is crucial to the success of our customers. All our staff are technically trained, and we have a team of people ready to help you.

INTERNATIONAL

Globally connected operations within 30 countries, and across 5 continents. We are continually customising our products and services to suit the individual needs of our international customer base.

CHARITABLE GIVING

We continue to support local charities such as Maytree Respite Centre, the Brain Tumour Charity, and local sports teams and organisations. We recognise these institutions, and all their voluntary work, as being inspiring and unconditional.

REFRIGERATION



DAIRY CABINET SUPERMARKET PUMPS

These dairy cabinet supermarket pumps can fit under low display cabinets due to being just 76mm in height. The multiple inlets offer a variety of installation options for the contractor.



Part code	Description	Tank capacity	Max head	Max flow	Dimensions mm (HxWxD)	Discharge size (inches)
DCP-30A	Dairy cabinet pump (standard with safety switch)	5.5L	23m	700LPH	76 x 200 x 610	1/2
DCP-30E	Dairy cabinet pump (no S/S or L/D)	5.5L	23m	700LPH	76 x 200 x 610	1/2
DCP-30V	Dairy cabinet pump (vertical)	4.5L	23m	700LPH	200 x 580 x 76	1/2
DCP-30-LFA	Dairy cabinet standard	3L	6m	60 LPH	66 x 200 x 410	1/2
DCP-30-LFE	Dairy cabinet economy	3L	6m	60 LPH	66 x 200 x 410	1/2
DCP-P	High-pressure replacement pump	-	-	700LPH	-	3/8

EVAPORATOR TRAY

A thermostatically- controlled cast aluminium tray designed to collect and evaporate condensate water. Ideal for refrigeration display cabinets.



Part code	Description	Tank capacity	Evaporation rate	Dimensions mm (HxWxD)	Weight
ET-150	Evaporator tray	1.5L	150ml per hour	90 x 320 x 120	1.1kg

VIBRATION ABSORBER

Designed for the installation of the suction and discharge lines of air conditioning and refrigeration systems. Used to dampen compressor-induced vibrations and reduce the damage to the system's pipework.



Part code	Description	Tube OD (inches)	Tube OD (mm)	Max working pressure (PsiG)	Burst pressure (PsiG)
VIBA-1/4	Vibration Absorber 1/4 (6mm)	1/4	6mm	650 (44.8 bar)	3250 (224 bar)
VIBA-3/8	Vibration Absorber 3/8 (10mm)	3/8	10mm	650 (44.8 bar)	3250 (224 bar)
VIBA-1/2	Vibration Absorber 1/2 (12mm)	1/2	12mm	650 (44.8 bar)	3250 (224 bar)
VIBA-5/8	Vibration Absorber 5/8 (16mm)	5/8	16mm	650 (44.8 bar)	3250 (224 bar)
VIBA-3/4	Vibration Absorber 3/4 (18mm)	3/4	18mm	650 (44.8 bar)	3250 (224 bar)
VIBA-7/8	Vibration Absorber 7/8 (22mm)	7/8	22mm	650 (44.8 bar)	3250 (224 bar)
VIBA-1-1/8	Vibration Absorber 1-1/8 (28mm)	1-1/8	28mm	600 (41.3 bar)	3000 (206.8 bar)
VIBA-1-3/8	Vibration Absorber 1-3/8 (35mm)	1-3/8	35mm	550 (37.9 bar)	2750 (189.6 bar)
VIBA-1-5/8	Vibration Absorber 1-5/8 (42mm)	1-5/8	42mm	510 (35.1 bar)	2550 (175.8 bar)
VIBA-2-1/8	Vibration Absorber 2-1/8 (54mm)	2-1/8	54mm	400 (27.5 bar)	2000 (137.8 bar)
VIBA-2-5/8	Vibration Absorber 2-5/8 (64mm)	2-5/8	64mm	350 (24.1 bar)	1750 (120.6 bar)
VIBA-3-1/8	Vibration Absorber 3-1/8 (76mm)	3-1/8	76mm	320 (22.0 bar)	1600 (110.3 bar)
VIBA-3-5/8	Vibration Absorber 3-5/8 (89mm)	3-5/8	89mm	190 (13.1 bar)	570 (39.3 bar)
VIBA-4-1/8	Vibration Absorber 4-1/8 (108mm)	4-1/8	108mm	190 (13.1 bar)	570 (39.3 bar)

K-KLAMP - PIPE AND INSULATION CLAMP

K-KLAMP eliminates having to double-wrap, glue and tape the insulation on strut-mounted clamps. K-KLAMP pipe and insulation coupling reduces the time required to insulate copper tubing used for refrigerant lines. Our clamp allows sections of closed-cell insulation to be secured at fixing points.



Part code per size	Insulation wall thickness			
	3/8"	1/2"	3/4"	1"
1/4"	K38-14	-	K34-14	-
3/8"	K38-38	K12-38	K34-38	-
1/2"	K38-12	K12-12	K34-12	K100-12
5/8"	K38-58	K12-58	K34-58	K100-58
3/4"	K38-34	K12-34	K34-34	K100-34
7/8"	K38-78	K12-78	K34-78	K100-78
1"	K38-100	K12-100	-	-
1-1/8"	K38-118	K12-118	K34-118	K100-118
1-3/8"	K38-138	K12-138	K34-138	K100-138
1-5/8"	K38-158	K12-158	K34-158	K100-158
2-1/8"	K38-218	K12-218	K34-218	K100-218
2-5/8"	-	K12-258	K34-258	K100-258
3-1/8"	-	K12-318	K34-318	K100-318
3-5/8"	-	K12-358	K34-358	K100-358
4-1/8"	-	K12-418	K34-418	K100-418

Klo-Shure Part code	Discharge size (inches)
729037	Klo-Shure 3/8" ID x 1-1/2"
729050	Klo-Shure 1/2" ID x 1-1/2"
729062	Klo-Shure 5/8" ID x 1-1/2"
729087	Klo-Shure 7/8" ID x 1-1/2"
729112	Klo-Shure 1-1/8" ID x 1-1/2"
729137	Klo-Shure 1-3/8" ID x 1-1/2"
729162	Klo-Shure 1-5/8" ID x 1-1/2"
729212	Klo-Shure 2-1/8" ID x 1-1/2"
729262	Klo-Shure 2-5/8" ID x 1-1/2"
729312	Klo-Shure 3-1/8" ID x 1-1/2"
729412	Klo-Shure 4-1/8" ID x 1-1/2"

UNIVERSAL MULTI-FIT FAN MOTORS

Universal multi-fit fan motors are individually boxed and come complete with fixings. The 1m power cord offers flexibility during installation. CE certified / ROHS-2 compliant.



Part code	Description	Watts	Voltage	Frequency	Revs	Cable length
FM-5W	Universal multi-fit fan motor - 5W	5W	240V	50-60Hz	1300/1500 rpm	1m
FM-7W	Universal multi-fit fan motor - 7W	7W	240V	50-60Hz	1300/1500 rpm	1m
FM-10W	Universal multi-fit fan motor - 10W	10W	240V	50-60Hz	1300/1500 rpm	1m
FM-16W	Universal multi-fit fan motor - 16W	16W	240V	50-60Hz	1300/1500 rpm	1m
FM-18W	Universal multi-fit fan motor - 18W	18W	240V	50-60Hz	1300/1500 rpm	1m
FM-25W	Universal multi-fit fan motor - 25W	25W	240V	50-60Hz	1300/1500 rpm	1m
FM-34W	Universal multi-fit fan motor - 5W	34W	240V	50-60Hz	1300/1500 rpm	1m

TANGENTIAL FAN MOTORS

Tangential single-impeller fan motor assemblies with aluminium blades. Individually boxed complete with fixings. CE certified / ROHS-2 compliant.



Part code	Description	Watts	Blade length	Rotate speed	Air flow
FMTS-ISW-120	Tangential Fan Motor 15W with 120mm Blade	15W	120mm	2200rpm	80m ³ /h
FMTS-20W-120	Tangential Fan Motor 20W with 180mm Blade	20W	180mm	2000rpm	120m ³ /h
FMTS-30W-240	Tangential Fan Motor 30W with 240mm Blade	30W	240mm	2100rpm	170m ³ /h
FMTS-30W-300	Tangential Fan Motor 30W with 300mm Blade	30W	300mm	1900rpm	190m ³ /h

AXIAL FAN MOTORS

Axial shaded fan motors have a compact structure and small volume. Lightweight, low noise and used on refrigeration equipment. Individually boxed, CE certified/ ROHS-2 compliant, these motors have an ambient operating temperature -20° C to +60° C



Part code	Description	Watts	Voltage	Frequency	Revs	Cable length	Air flow
FM-A-8038-L	Axial Fan Motor - 15W (with lead)	15W	240V	50Hz	2200rpm	30mm	40m ³ /h
FM-A-12025-L	Axial Fan Motor - 13W (with lead)	15W	240V	50Hz	1800rpm	30mm	71m ³ /h
FM-A-12038-L	Axial Fan Motor - 20W (with lead)	20W	240V	50Hz	2500rpm	30mm	132m ³ /h
FM-A-12038-T	Axial Fan Motor - 20W (with terminal)	20W	240V	50Hz	2500rpm	-	132m ³ /h

Part code	Description	Watts	Db(A) rating	Height	Width	Depth
FM-A-8038-L	Axial Fan Motor - 15W (with lead)	15W	23.4	80mm	80mm	38mm
FM-A-12025-L	Axial Fan Motor - 13W (with lead)	15W	35.6	120mm	120mm	26mm
FM-A-12038-L	Axial Fan Motor - 20W (with lead)	20W	37.3	120mm	120mm	38mm
FM-A-12038-T	Axial Fan Motor - 20W (with terminal)	20W	37.3	120mm	120mm	38mm

FAN MOTOR ASSEMBLIES

A complete range of pressed aluminium blades, fan rings, guards and brackets to suit our range of multi-fit fan motors. Available in a variety of diameters and pitches to suit most refrigeration applications. All accessories can be sold as individual items or as a complete assembly combined to create your own fan requirements.



Part code	Description	Diameter	Pitch
FBS-154-25	Fan Blade - sucker	154mm	25°
FBS-154-31	Fan Blade - sucker	154mm	31°
FBS-172-25	Fan Blade - sucker	172mm	25°
FBS-172-31	Fan Blade - sucker	172mm	31°
FBS-200-25	Fan Blade - sucker	200mm	25°
FBS-200-31	Fan Blade - sucker	200mm	31°
FBS-230-25	Fan Blade - sucker	230mm	25°
FBS-230-31	Fan Blade - sucker	230mm	31°
FBS-254-25	Fan Blade - sucker	254mm	25°
FBS-254-31	Fan Blade - sucker	254mm	31°
FBS-300-25	Fan Blade - sucker	300mm	25°
FBS-300-31	Fan Blade - sucker	300mm	31°

Part code	Description	Diameter	Pitch
FBB-154-25	Fan Blade - blower	154mm	25°
FBB-154-31	Fan Blade - blower	154mm	31°
FBB-172-25	Fan Blade - blower	172mm	25°
FBB-172-31	Fan Blade - blower	172mm	31°
FBB-200-25	Fan Blade - blower	200mm	25°
FBB-200-31	Fan Blade - blower	200mm	31°
FBB-230-25	Fan Blade - blower	230mm	25°
FBB-230-31	Fan Blade - blower	230mm	31°
FBB-254-25	Fan Blade - blower	254mm	25°
FBB-254-31	Fan Blade - blower	254mm	31°
FBB-300-25	Fan Blade - blower	300mm	25°
FBB-300-31	Fan Blade - blower	300mm	31°

Part code	Description	Diameter
FRS-154	Fan ring	154mm
FRS-172	Fan ring	154mm
FRS-200	Fan ring	172mm
FRS-230	Fan ring	172mm
FRS-254	Fan ring	200mm
FRS-300	Fan ring	200mm

Part code	Description	Diameter
FG-154	Fan guard	154mm
FG-172	Fan guard	154mm
FG-200	Fan guard	172mm
FG-230	Fan guard	172mm
FG-254	Fan guard	200mm
FG-300	Fan guard	200mm

Part code	Height	Width	Depth
FBR-109-1	109mm	81mm	24mm
FBR-109-2	109mm	78mm	49mm
FBR-109-3	109mm	78mm	49mm
FBR-39	39mm	-	-
FBR-55	55mm	-	-
FBR-72	72mm	-	-
FBR-84	84mm	-	-

FAN MOTOR



FAN BLADE



FAN BRACKET



FAN RING



FAN GUARD

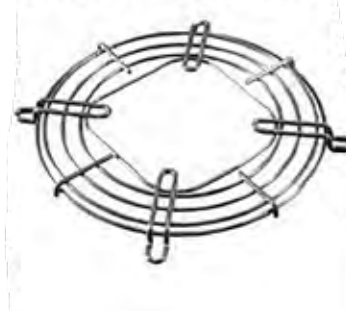

ISOLATORS



ROTARY ENCLOSED ISOLATORS

Our insulated 3 and 4 pole rotary enclosed isolators are CE marked and suitable for disconnecting the power supply to outdoor air conditioning units.

The isolators are weatherproof to IP65, easy to install and conform to IEC 60947-3. They have a lockable off position and interlocking cover which can be removed only in the off position. Earth and neutral terminals included and M20/25 knockouts up to 63A.



Part code	No of poles	AMPS AC21	AC23 A 240VA	AC23 A 400VA	Cable capacity		Height	Width	Depth
					Solid	Stranded			
IS-3P-20A-S-G	3	20amp	5.5kW	3.7kW	1-16mm ²	0.75-10mm ²	125mm	100mm	120mm
IS-3P-32A-S-G	3	32 amp	11kW	7.5kW	1-16mm ²	0.75-10mm ²	125mm	100mm	120mm
IS-3P-20A-G	3	20amp	5.5kW	3.7kW	1-16mm ²	0.75-10mm ²	175mm	114mm	135mm
IS-3P-32A-G	3	30amp	11kW	7.5kW	1-16mm ²	0.75-10mm ²	175mm	114mm	135mm
IS-3P-40A-G	3	40amp	15kW	11kW	1-16mm ²	0.75-10mm ²	175mm	114mm	135mm
IS-3P-63A-G	3	63amp	22kW	18.5kW	1-16mm ²	0.75-10mm ²	175mm	114mm	135mm
IS-4P-20A-S-G	4	20amp	5.5kW	3.7kW	1-16mm ²	0.75-10mm ²	125mm	100mm	120mm
IS-4P-32A-S-G	4	32 amp	11kW	7.5kW	1-16mm ²	0.75-10mm ²	125mm	100mm	120mm
IS-4P-20A-G	4	20amp	5.5kW	3.7kW	1-16mm ²	0.75-10mm ²	175mm	114mm	135mm
IS-4P-32A-G	4	32amp	11kW	7.5kW	1-16mm ²	0.75-10mm ²	175mm	114mm	135mm
IS-4P-40A-G	4	40amp	15kW	11kW	1-16mm ²	0.75-10mm ²	175mm	114mm	135mm
IS-4P-63A-G	4	63amp	22kW	18.5kW	1-16mm ²	0.75-10mm ²	175mm	114mm	135mm

PROTECTIVE HOUSING



Easy-Fit housings are manufactured in two sizes and are ideal for all brands of outdoor refrigeration condensing equipment.

The steel goes through an 8-phase epoxy polyester powder coating process and is finished with a scratch resistant textured finish in RAL 7032.



Part code	Size	External dimensions mm			Internal dimensions mm			Weight
		H	W	D	H	W	D	
CH-S	Small	500	710	600	410	640	530	23kg
CH-L	Large	550	810	720	460	740	640	30kg

REFRIGERANT ID LABELS

A range of self adhesive vinyl labels. Each label indicates the type of refrigerant and come in a handy pack of 10. We also supply pipe labels. Avoid costly mistakes by properly identifying the type of refrigerant contained in recovery cylinders and air conditioning and refrigeration equipment. Contact us for more information.





Part code	Description	Size
601231292	Fuchs Reniso Triton SEZ 22	5 L
600669812	Fuchs Renison Triton SEZ 32	1L
601231339	Fuchs Reniso Triton SEZ 32	5L
600646509	Fuchs Reniso Triton SE55	1L
601231414	Fuchs Reniso Triton SE 55	5 L
600680107	Fuchs Reniso Triton SEZ 68	1L
601231254	Fuchs Renison Triton SEZ 68	5L
601231278	Fuchs Reniso Triton SE 170	5L
600680442	Fuchs Reniso Triton SE 170	10L
600756512	Fuchs Reniso PAG 100	1L
600741105	Fuchs Reniso C85 E	1L
600360382	Fuchs Reniso C85 E	10L

WHY USE FUCHS

<p>1 High thermo-chemical stability e.g. in Sealed Glass Tube Test (ASHRAE 97-2007)</p> <p>Standard POE refrigeration oils RENISO TRITON SEZ 80</p>	<p>2 Very good miscibility with HFC/FC: e.g. in miscibility evaluation (DIN 51514)</p> <p>Standard POE refrigeration oils RENISO TRITON SEZ 80</p>	<p>3 Low varnish / low sludge formation e.g. in FUCHS In-house test (evaluation of oil sludge in beaker with bearing roller after 168h/135 °C)</p> <p>Standard POE refrigeration oils RENISO TRITON SEZ 80</p>	<p>4 Reliable wear protection e.g. in bearing wear testing (DIN 51819-3)</p> <p>Standard POE refrigeration oils RENISO TRITON SEZ 80</p>
---	--	--	--

LUBRICANTS.
TECHNOLOGY.
PEOPLE.



RENISO TRITON SE/SEZ

Synthetic refrigeration oils based on poly esters (POE) for HFC/FC refrigerants

RENISO C 85 E

Synthetic refrigeration oil for CO₂ compressors

RENISO PAG 100

Special polyalkylene glycols (PAG) for mobile AC systems

FUCHS RANGE

PAGE 138

DIVERSITECH®
INTERNATIONAL



**AUTHORISED
PARTNER**

AIR CONDITIONING

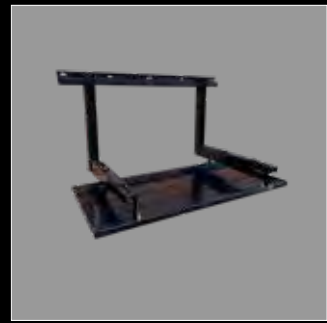

A close-up photograph of a Hilmer orbital flare fitting. The fitting is made of polished metal and features a central circular opening with a conical inner surface. The outer ring has a hexagonal shape with chamfered edges. The background is dark, highlighting the metallic texture and precision of the component.

Hilmer® RANGE

PAGE 201

Orbital Flare
1838952

CONDENSATE PUMPS AND ACCESSORIES



DiversiTech International stock a range of various branded condensate removal tank pumps.



PH-1L/PH-1SS



PH-2L-SS-BLACK



VCCA-20S



VCMX-20S



VCMA-20S



WHISPA-Q 1 & 2L



PH-2L/PH-2LSS



VCL-24S



VCL-45S

Part code	Description	Max head	Max flow	dB(A)	Dimensions mm (HxWxD)	Discharge size (Inches)
PH-1L / PH-1L-SS	1 Litre Tank Pump	6.8m	456 LPH	43	141x220x134	3/8 / 1/4
PH-2L-SS-BLACK	2 litre tank pump	7.2m	480 LPH	43	179x135x286	3/8 / 1/4
VCCA-20S	1 Litre Tank Pump	4.3m	294 LPH	58-62	125x300x125	1/4 & 3/8
VCMX-20S	1.4 Litre Tank Pump	4.8m	284 LPH	58	165x260x122	1/4 & 3/8
VCMA-20S	1.9 Litre Tank Pump	4.3m	294 LPH	58-62	178x288x127	1/4 & 3/8
PH-2L / PH-2L-SS	2 Litre Tank Pump	7.2m	480 LPH	43	179x135x286	3/8 / 1/4
VCL-24S	3.8 Litre Tank Pump	5.9m	900 LPH	58-62	263x305x150	1/4 & 3/8
VCL-45S	3.8 Litre Tank Pump	10.5m	1560 LPH	58-62	267x305x150	3/8
REDBOX-1L-S	1 Litre Tank Pump	5.1m	280 LPH	44	120x150x300	3/8 & 1/4
REDBOX-2L-S	2 Litre Tank Pump	5.1m	280 LPH	44	170x150x300	3/8 & 1/4
WHISPA-Q-1L	1 Litre Tank Pump	6m	14 LPH	19	127x81x170	1/4
WHISPA-Q-2L	2 Litre Tank Pump	6m	14 LPH	19	165x135x250	1/4

CONDENSATE PUMPS AND ACCESSORIES



REDBOX-1L-S 1 LITRE CONDENSATE PUMP

The DiversiTech RedBox 1 Litre Tank Pump is a condensate tank pump with a flow rate of 280 LPH and a lift of 5.1 metres. This pump has metal mounting tabs which allows the tank to be screwed to the wall. The universal power lead makes the pump easy to install, service and retrofit.

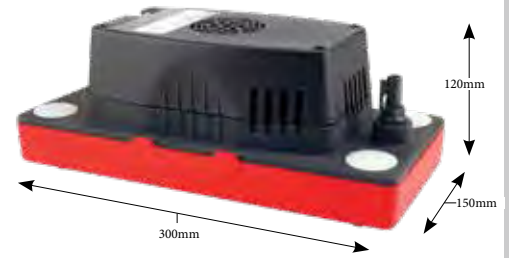

The unique LED indicators highlight when the pump has power, is running and when the high level alarm has been activated.



MAX. FLOW 280 LPH



TANK CAP. 1L



DECIBEL RATING 44 DB(A)

Part code	Max. lift	Discharge size	Watts	IP	Amps	Volts	HZ
REDBOX-1L-S	5.1m	3/8" / 1/4"	60W	20	1.0A	230V	50Hz

High level alarm	Inlet height fr. base	Weight	Cable length	Drink cycle	On level	Off level	Reserve before overflow	Alarm level
230V / 3A	112mm	2.3kg	1.8m	460ml	15.5mm	6mm	140ml	25mm

REDBOX-2L-S 2 LITRE CONDENSATE PUMP

The DiversiTech RedBox 2 Litre Tank Pump is a condensate tank pump with a flow rate of 280 LPH and a lift of 5.1 metres. This pump has metal mounting tabs which allows the tank to be screwed to the wall. The universal power lead makes the pump easy to install, service and retrofit.



The unique LED indicators highlight when the pump has power, is running and when the high level alarm has been activated.



MAX. FLOW 280 LPH



TANK CAP. 2L



DECIBEL RATING 44 DB(A)

Part code	Max. lift	Discharge size	Watts	IP	Amps	Volts	HZ
REDBOX-2L-S	5.1m	3/8" / 1/4"	60W	20	1.0A	230V	50Hz

High level alarm	Inlet height fr. base	Weight	Cable length	Drink cycle	On level	Off level	Reserve before overflow	Alarm level
230V / 3A	112mm	2.3kg	1.8m	1450ml	47mm	6.5mm	375ml	52mm

REDBOX SERIES

MINI PUMPS

DiversiTech International stock a range of mini condensate pumps ideal for split air conditioning systems, small enough to be placed in the unit, or within trunking. We also provide mini pump options that come with an elbow and length of trunking.



EC-1 (PUMP ONLY)



WHISPA-Q MINI AND TRUNKING



EC-1 KIT with elbow and trunking



REDBOX-TUBE

Part code	Description	Max head	Max flow	dB(A)	Dimensions mm (HxWxD)	Discharge size (inches)
EC-1	1 Litre Tank Pump	10m	10 LPH	21	104x46x58	1/4"
EC-1 KIT	Mini pump with trunking	10m	10 LPH	21	104x46x58	1/4"
REDBOX-TUBE	Mini pump	3m	20 LPH	21	159.8x36.8x31	-
WHISPA-Q-TRUNK	Mini pump with trunking	6m	16 LPH	21	-	-
MF-2	Mini Flowatch 2	10m	12 LPH	< 21	800x150x80	1/4"

CONDENSATE PUMPS AND ACCESSORIES



REDBOX TRUNK

The REDBOX TRUNK is designed for straightforward installation and can be fitted to either the left- or right-hand side of the air conditioning system. Additionally, this pump features a physical float switch within the reservoir—a key reliability feature that is not always offered on comparable pumps.

TRUNKING SIZE (WxH): 80 X 60MM



REDBOX MINI UNIVERSAL

A mini condensate pump in the REDBOX series of pumps. Designed to automatically remove the drainage liquid produced by air conditioners of a maximum 7kW cooling capacity.



REDBOX MINI COMPACT

A mini condensate pump in the REDBOX series of pumps. Designed to automatically remove the drainage liquid produced by air conditioners of a maximum 7kW cooling capacity.



REDBOX MINI TUBE

A mini condensate pump in the REDBOX series of pumps. Designed to automatically remove the drainage liquid produced by air conditioners of a maximum 7kW cooling capacity.



REDBOX SLIM

A mini condensate pump in the REDBOX series of pumps. Designed to automatically remove the drainage liquid produced by air conditioners of a maximum 7kW cooling capacity.





REDBOX SERIES



REDBOX TRUNK
INSTALL VIDEO



REDBOX
COMPATIBILITY

Part code	Max head	Max flow	dB(A)	Pump size mm (HxWxD)	Reservoir size mm (HxWxD)	Drink cycle
REDBOX-TRUNK	15m	20 LPH	21	95.4 x 44 x 109.7mm	81 x 44 x 24.9mm	16ml
REDBOX-UNIVERSAL	15m	20 LPH	21	95.4 x 44 x 109.7mm	81 x 44 x 24.9mm	16ml
REDBOX-COMPACT	15m	20 LPH	21	119 x 31.5 x 50mm	75 x 43.2 x 40.3mm	12ml
REDBOX-TUBE	15m	20 LPH	21	159.8 x 36.8 x 31mm	75 x 43.2 x 40.3mm	10ml
REDBOX-SLIM	20m	29 LPH	-	282 X 62 X 59mm	-	20ml

CONDENSATE PUMPS AND ACCESSORIES



PRESSURE RELIEF & BOILER CONDENSATE PUMP

PRV*Sure*

This pump is manufactured from high temperature plastic, and comes complete with 10m of higher specification hose.

It meets EN standards and can handle temperatures up to 110 degrees. Supplied with 10m of 'no sag' high-grade braided hose. This unique design also cools PRV discharge so it is safe for use with solvent weld pipework. For installers who are audited or working to EN standards.



Part code	Description	Max head	Max flow	Temperature	Dimensions mm (HxWxD)	Discharge size
PH-3.8L-HW	Pressure relief and boiler condensate pump	8m	312 LPH	110°C	249x325x160	3/8 inch (9.5mm)

HIGH TEMPERATURE PRESSURE RELIEF PUMP

Designed for unvented cylinder T&P discharge and steam humidifiers. Having one of the largest discharge rates of 32 litres per minute this pump can handle both high temperatures (up to 100°C) and high flow rates.

Manufactured in the UK, this heavy-duty, high temperature tank pump incorporates thermal overload protection and a high level alarm switch.

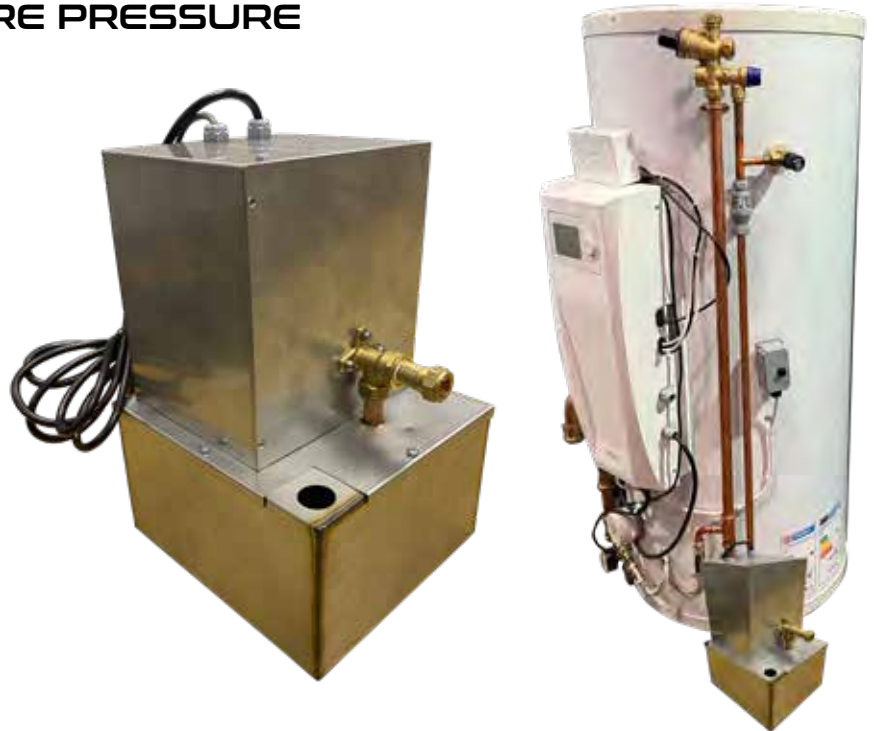

Part code	Description	Max head*	Max flow	Temperature	Dimensions mm (HxWxD)	Discharge size
PH-5L-HW	High temperature & pressure relief pump	8m / 20m	1920LPH 32LPM	100° C	350x190x260	15mm

*Max heads - 8m for flow rates up to 25L per minute / 20m for flow rates of 5L per minute

ADAPTORS

DiversiTech International stock a range of adaptors to connect the unit to the pump.



Part code	Description	Pump type application	Pack QTY
ADAP-CAC-S	Cassette adaptor - small (green) 3/4" x 1"	Tank pump / gravity	3 pack
ADAP-CAC-M	Cassette adaptor - medium (blue) 3/4" x 1-1/4"	Tank pump / gravity	3 pack
ADAP-CAC-L	Cassette adaptor - large (black) 3/4" x 1-1/2"	Tank pump / gravity	3 pack
ADAP-CAC-X	Cassette adaptor - multipack	Tank pump / gravity	3 pack
ADAP-1	Condensate drain adaptor - 22mm to 3/8" (95mm)	Tank pump - 9.5mm (3/8") outlet	Single
ecop-adap	Condensate drain adaptor - 16, 18, 22, 25mm to 3/8" hose	All pumps	Single
cv-38-3	Non-return check valve - 3/8" (9.5mm) VCMA/VCC	Tank pump - 9.5mm (3/8") outlet	3 pack
cv-14-3	Non-return check valve - 1/4" VCMA/VCC	Tank pump - (1/4") outlet	3 pack
ph-pump-nrv	Non-return check valve - 3/8" (9.5mm) PH	Tank pump - 9.5mm (3/8") outlet	Single
154724	Non-return check valve - 3/8" (9.5mm)	VCMX-20s pump	Single

SELF-SEALING PIPE ADAPTOR



The self-sealing adaptor is used to form a connection between the condensate hose and a soil and vent pipe. Drill a 13mm hole (for SVA-3) or a 10mm hole (for SVA-6), insert and twist to seal the connection.

Part code	Description	Pack QTY
SVA-3	Self-sealing pipe adaptor - 6mm & 9.5mm (1/4 & 3/8) hose to soil and vent pipe	3 pack
SV-ADAPTOR	Self-sealing pipe adaptor - 6mm & 9.5mm (1/4 & 3/8) hose to soil and vent pipe	Single
SVA-6-3	Self-sealing pipe adaptor - 6mm (1/4) hose to soil and vent pipe	3 pack
SV-ADAPTOR-6	Self-sealing pipe adaptor - 6mm (1/4) hose to soil and vent pipe	Single

AUDIBLE ALARM

This audible alarm can be wired into all pumps with a high-level alarm switch



Part code	Description	Pack QTY
AUDIBLE ALARM	Audible alarm for all pumps with a high-level alarm switch	3 pack

CONDENSATE PUMPS AND ACCESSORIES



CONDENSATE BRAIDED HOSE

Our reinforced PVC braided hose is suitable for condensate drains and comes packaged in clear shrink wrap for protection and easy storage. The black hose has no light penetration, which prevents build-up of mould growth.



CLEAR

Available in clear and black, in 6m and 30m coils.

Part code	Colour	Description	ID	OD	Pressure in bar		Min bend radius	Min temp *	Max temp
					Working	Burst			
RVT-1/4	Clear	1/4" x 30 metres	6mm	10mm	7	21	30°	-15°C	+60°C
RVT-3/8	Clear	3/8" x 30 metres	10mm	14mm	8	24	30°	-15°C	+60°C
RVT-1/2	Clear	1/2" x 30 metres	12mm	16mm	6	18	30°	-15°C	+60°C
RVT-5/8	Clear	5/8" x 30 metres	16mm	20mm	6	18	30°	-15°C	+60°C
RVT-1/4-B	Black	1/4" x 30 metres	6mm	10mm	7	21	30°	-15°C	+60°C
RVT-3/8-B	Black	3/8" x 30 metres	10mm	14mm	8	24	30°	-15°C	+60°C
RVT-1/2-B	Black	1/2" x 30 metres	12mm	16mm	6	18	30°	-15°C	+60°C
RVT-1/2-6	Clear	1/2" x 6 metres	12mm	16mm	6	18	30°	-15°C	+60°C
RVT-3/4-6	Clear	3/4" x 6 metres	19mm	23mm	6	18	30°	-15°C	+60°C

CLEAR VINYL HOSE



Applications include air conditioning and refrigeration condensate drains, condensate pumps discharge lines and humidifier overflows. Available in 30m coils.

Part code	Colour	Description	ID	OD	Quantity
VT-14	Clear	1/4" x 30 metres	6mm	10mm	30m
VT-38	Clear	3/8" x 30 metres	10mm	14mm	30m

Part code	Colour	Description	ID	OD	Quantity
7-14	Clear	1/4" x 30 metres	6.3mm	9.1mm	30m
7-38	Clear	3/8" x 30 metres	9.5mm	12.5mm	30m
7-12	Clear	1/2" x 30 metres	12.7mm	16mm	30m
7-58	Clear	5/8" x 30 metres	15.8mm	19.6mm	30m
7-34	Clear	3/4" x 30 metres	19mm	23.1mm	30m
7-10	Clear	1" x 15 metres	25.4mm	30.8mm	30m

CASTEL CORRUGATED HOSE



Ensure efficient drainage for your air conditioning systems with the Castel Flexible Drain Hose. Easy-to-use cut marks simplify installation, making it ideal for professional aircon setups. Perfect for ducted installations, it ensures hassle-free condensate water drainage without pressure.

Part code	Colour	Description	Length	Temp range	Quantity (pks)
A.DP.96	Ivory	16-18-20mm	50mm	0°C - 50°C	50

HOSE CONNECTORS AND CLAMPS

A range of nylon hose connectors and clamps for the connection of hoses. Secure fittings that prevent leaks.

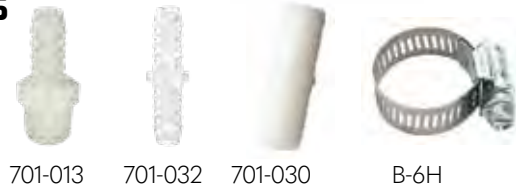

Part code	Description	Pack qty
701-030	Hose connector - nylon 1/4	Single
701-032	Hose connector - nylon 3/8	Single

Part code	Description	Pack qty
B-4H	Hose clamp 3/16-5/16	Single
B-6H	Hose clamp 1/4-3/8	Single

CONDENSATE COP™

Condensate Cop™ is a unique clamp-on float switch intended for HVAC drain pan installation. The Condensate Cop features a large over-clamping area that fits easily over the edge of all types of drain pans; including formed plastic and galvanized sheet metal.



Part code	Description	UOM	Master quantity
CC-1	Condensate Cop™ drain pan switch	Each	12

CSL 200 AC SHUTOFF SWITCH

The CS7 200 is an easy to install, reliable, condensate overflow detection switch. Featuring a unique universal pan mount design to assure accurate detection in metal or plastic secondary drain pans.



Part code	Description	UOM	Master quantity
CSL200	AC shut off switch	Each	12

DRAIN DAWG™

The Drain Dawg™ is a complete condensate drain cleaning kit, including the CT-475M deluxe nitrogen / CO2 0-475 psi regulator, the TG-10 & BS-25 ten foot hose and blowgun assembly, and the CW-15 fifteen inch whip hose.



Part code	Description	UOM	Master quantity
CB-2	Drain Dawg™ kit	Each	3

CONDENSING UNIT GUARDS



CONDENSING GUARDS

DiversiTech manufacture a range of weather-resistant, steel mesh guards, offering a safe solution to vandalism and accidental damage of your expensive AC unit or ASHP. The range is ideal for all manufacturers of air conditioning and air source heat pump units. The unique sliding panel system allows for easy installation, which are secured into place when the front panel is fitted. Back panels are also available to make the guard free standing. For high wall-mounted units, we can offer a base panel for full security.



BASIC COLOUR - RAL 7032

Part code	Size	External dimensions mm (HxWxD)			Internal dimensions mm (HxWxD)			Weight
CG-S	S	750	1050	460	720	1020	450	18kg
CG-M	M	1150	1150	650	1120	1120	640	27kg
CG-L	L	1450	1150	650	1420	1120	640	30kg
CG-XL	XL	1800	1150	650	1770	1120	640	40kg
CG-S-BLACK	S	750	1050	460	720	1020	450	18kg
CG-M-BLACK	M	1150	1150	650	1120	1120	640	27kg
CG-L-BLACK	L	1450	1150	650	1420	1120	640	30kg
CG-XL-BLACK	XL	1800	1150	650	1770	1120	640	40kg
CG-500-S	S	620	1050	500	590	990	470	13kg
CG-500-M	M	1020	1050	500	990	990	470	18kg
CG-500-L	L	1420	1050	500	1390	990	470	23kg
CG-750-S	S	950	1150	750	920	1120	740	25kg
CG-750-S-INV	S	950	1450	750	920	1420	740	25.1kg
CG-750-M	M	1150	1150	750	1120	1120	740	32kg
CG-750-L	L	1450	1150	750	1420	1120	740	33kg
CG-750-INV	INV	1150	1450	750	1120	1420	740	33kg
CG-900L-INV	L-INV	1150	1450	900	1120	1420	890	34kg
CG-900L-SQ	L-SQ	1450	1450	900	1420	1370	890	51kg
CG-900-XXL	XXL	1800	1450	900	1770	1370	890	60kg
* CG-VRF-BP	BP-S	2000	1160	1200	1970	1130	1200	64kg
* CG-VRF-EP-6	EP-S	2000	580	1200	1970		1200	24kg
* CG-VRF-EP-12	EP-M	2000	1160	1200	1970		1200	41kg

* These products have a carriage surcharge

WOODEN GUARDS

Made from tanalised, pressure-treated timber. All panels have rounded louvers to optimise air flow. Sized to protect both ASHP and AC units, these guards offer a solution for listed buildings and sites where aesthetics are a consideration. All components are flat-packed for easy transport, and easy-to-install and assemble.



Part code	Size	External dimensions mm (HxWxD)			Internal dimensions mm (HxWxD)			Weight
CG-750S-WOOD	S	905/960	1275	865	850/890	1055	753	35kg
CG-750M-WOOD	M	1135/1135	1275	865	1075/1115	1055	753	40kg
CG-750M+WOOD	M+	255/1310	1275	865	1200/1240	1055	753	44kg
CG-750L-WOOD	L	1530/1585	1275	865	1475/1515	1055	753	51kg
CG-750L-INV-WOOD	L-INV	1130/1185	1630	865	1075/1115	1405	753	47kg
CG-750L+WOOD	L+	1600/1655	1275	865	1545/1585	1055	753	57kg
CG-750L+INV-WOOD	L+INV	1655/1690	1630	865	1580/1620	1405	753	59kg

WALL MOUNTING BRACKETS

BASIC COLOUR
RAL 7032

Diversitech International offer a range of flat packed brackets, the Type 1 bracket has uprights and mounts directly onto the wall. Type 2 comes with a crossbar so that the uprights can be spaced exactly as required. The integral spirit level makes installation easier. Type 3 brackets have a unique interlocking mechanism enabling the arms to be joined in a matter of seconds.

For improved corrosion resistance all metal receives a 100% zinc plating, followed by a hard ED coating, before being finished with an external grade polyester textured powder coating in RAL 7032.

For lighter condensing units we offer an economy version. This incorporates the traditional crossbar style for easy spacing of the support arms. We also offer a range of stainless steel brackets, which are recommended for coastal locations exposed to sea salt or in corrosive environments.

WEATHER PROTECTION PROCESS ALL BRACKETS



PROCESS ONE
Corrosion resistant raw material, often referred to as Zintec



PROCESS TWO
Zinc phosphating process multi stage cleaning and dipping chemical zinc



PROCESS THREE
ED coating process: electrophoretic deposition (aka ED or EPD) coating



PROCESS FOUR
Epoxy polyester powder coating

NB: SEA SALTS ARE VERY CORROSIVE AND AFFECT BOTH FERROUS AND NON-FERROUS METALS. COASTAL INSTALLATIONS ARE PARTICULARLY AT RISK AS THEY ARE FREQUENTLY EXPOSED TO SEA SALT SOLUTIONS FOLLOWED BY DRY PERIODS, WHERE THIS WET/DRY CYCLE PRODUCES A VERY CORROSIVE ENVIRONMENT. WE STRONGLY RECOMMEND THAT IN SUCH LOCATIONS ONLY OUR STAINLESS STEEL BRACKETS ARE INSTALLED.

TYPE 1 BRACKETS

BASIC COLOUR
RAL 7032

These flat-packed, self-assembly brackets provide a professional finish to the installation of wall-mounted outdoor condensing units and air source heat pumps. The Type 1 brackets have uprights that mount directly on to the wall via six shell anchor bolts provided, maximising the rigidity of the installation. For improved corrosion resistance all metal now receives a 100% zinc plating, followed by a hard ED coating, before being finished with an external grade polyester powder coating in RAL 7032.



Part code	Description	Safe working load*	Max load	Upright	Support arm	Weight
CBR1-S	Type 1 Bracket - Small	60kg	120kg	450mm	480mm	3.6kg
CBR1-M	Type 1 Bracket - Medium	90kg	180kg	500mm	530mm	4.6kg
CBR1-L	Type 1 Bracket - Large	140kg	280kg	550mm	580mm	4.7kg
CBR1-XL	Type 1 Bracket - Extra Large	250kg	500kg	550mm	660mm	8.8kg
CBR1-XXL	Type 1 Bracket - 2 x Extra Large	250kg	500kg	550mm	1000mm	11kg

CONDENSING BRACKETS



TYPE 2 BRACKETS

BASIC COLOUR
RAL 7032

These flat-packed, self assembly brackets provide a professional finish to the installation of wall mounted outdoor condensing units and air source heat pumps. The Type 2 brackets have a crossbar allowing the uprights to be spaced exactly as required, and include wall spacers to help level the unit on uneven walls. All components receive a powder coating, with a scratch resistant, textured finish in a colour (RAL 7032) to match most brands of condensing units and domestic air source heat pumps.



Part code	Description	Safe working load*	Max load	Crossbar	Upright	Support arm	Weight
CBR2-S	Type 2 Bracket - Small	60kg	120kg	720mm	400mm	400mm	3.8kg
CBR2-M	Type 2 Bracket - Medium	90kg	180kg	900mm	500mm	500mm	4.6kg
CBR2-L	Type 2 Bracket - Large	140kg	280kg	1040mm	550mm	540mm	6.6kg
CBR2-XL	Type 2 Bracket - XL	250kg	500kg	1040mm	550mm	660mm	16.2kg
CBR2-XXL	Type 2 Bracket - Double XL	200kg	400kg	1040mm	550mm	780mm	17.3kg

Part code	Description (BLACK)	Safe working load*	Max load	Crossbar	Upright	Support arm	Weight
CBR2-XL-BL	Type 2 Bracket - XL	250kg	500kg	1040mm	550mm	660mm	16.2kg
CBR2-XL-3A-BL	Type 2 Bracket - XL (3 arms)	250kg	500kg	1040mm	550mm	660mm	21.5kg
CBR2-XXL-BL	Type 2 Bracket - Double XL	200kg	400kg	1040mm	550mm	780mm	17.3kg
CBR2-XXL-3A-BL	Type 2 Bracket - Double XL (3 arms)	200kg	400kg	1120mm	550mm	780mm	22.6kg

Part code	Description	Safe working load*	Max load	Crossbar	Upright	Support arm	Weight
CBR2-XL-3A	Type 2 Bracket - XL (3 arms)	250kg	500kg	1040mm	550mm	660mm	21.5kg
CBR2-XXL-3A	Type 2 Bracket - Double XL (3 arms)	200kg	400kg	1040mm	550mm	780mm	22.6kg

Part code	Description	Safe working load	Crossbar	Arm length	Weight
CBR2-EL	Economy bracket with crossbar	70kg*	800mm	550mm	3.73kg
CBE-140	Economy bracket with crossbar	140kg*	1000mm	550mm	5.5kg

* All brackets are tested to twice the safe working load at an independent UK facility.

CONDENSING BRACKETS



TYPE 3 BRACKETS

BASIC COLOUR
RAL 7032

The unique, interlocking mechanism of the Type 3 condensing unit brackets enable the arms to be joined to the uprights in a matter of seconds. A spring-lock automatically secures the joint, preventing the arms being dislodged accidentally. For improved corrosion resistance all metal now receives a 100% zinc plating, followed by a hard ED coating, before being finished with an external grade polyester powder coating in RAL 7032.



Part code	Description	Safe working load*	Max load	Upright	Support arm	Weight
CBR3-M	Type 3 Bracket - Medium	90kg	180kg	900mm	500mm	6.8kg
CBR3-L	Type 3 Bracket - Large	140kg	280kg	1040mm	540mm	8.3kg

*All brackets are tested to twice the safe working loads at an independent UK facility.

* It is the installer's responsibility to ensure that equipment weights do not exceed the safe working loads quoted and that the roof structure onto which these products are being applied is sufficiently sound to withstand the weight and point loading. If these products are used in contact with a PVC roof membrane, the installer should seek advice from the membrane manufacturer on the possible migration of plasticizers, and the effect of this on the roof guarantee. These products should not be used for any purpose other than that for which they have been designed, and the products must not be modified in any way. DiversiTech accepts no liability for damage caused by the incorrect application or installation of these products.



CONDENSING BRACKETS



STAINLESS STEEL WALL MOUNTING BRACKETS

Part code	Description	Specification
CBR2-M-SS	Condenser Mounting Bracket	Type 2 - 316SS 90kg
CBR2-L-SS	Condenser Mounting Bracket	Type 2 316SS - 140kg
CBR2-XL-SS	Condenser Mounting Bracket	Type 2 316SS-160kg

ANTI-VIBRATION MOUNTING BOLTS

The anti-vibration mounting bolts are in a convenient pack of 4. Each pack can be used with our wall brackets and is used as a method to absorb the vibrations generated by an ASHP or condensing unit.



Part code	Description	For use with	Pack QTY
AVMB-1	Anti-vibration Mounting Bolts	All brackets	4

CANTILEVER ARMS / CANTILEVER ARM KITS

These ready-made, hot-dipped galvanised steel cantilever arms with 14mm diameter holes, offer a quick and easy method of supporting condensing units on external walls. Available in straight or webbed versions, in a variety of lengths. This is a low cost option to mounting AC units or ASHP's.

The cantilever arm kits come with all of the fixings needed for a quick and easy installation.

Part code	Description	Safe working load*	Length	Weight
CA-150-S	Cantilever arm - Single 150mm	250kg	150mm	0.8kg
CA-300-S	Cantilever arm - Single 300mm	250kg	300mm	1kg
CA-450-S	Cantilever arm - Single 450mm	250kg	450mm	1.4kg
CA-600-S	Cantilever arm - Single 600mm	190kg	600mm	2kg
CA-750-S	Cantilever arm - Single 750mm	150kg	750mm	2.4kg
CA-900-S	Cantilever arm - Single 900mm	120kg	900mm	3kg



CANTILEVER WEBBED ARM

CA-600-W	Cantilever arm - Webbed 600mm	190kg	600mm	2.6kg
CA-750-W	Cantilever arm - Webbed 750mm	150kg	750mm	3kg
CA-950-W	Cantilever arm - Webbed 950mm	150kg	950mm	3kg
CA-1200-W	Cantilever arm - Webbed 1200mm	150kg	1200 mm	3kg



CANTILEVER SINGLE ARM

CA-600-D	Cantilever arm - Double 600mm	243kg	600mm	3.7kg
CA-750-D	Cantilever arm - Double 750mm	205kg	750mm	4.5kg
CA-900-D	Cantilever arm - Double 900mm	140kg	900mm	5.6kg
CA-1200-D	Cantilever arm - Double 1200mm	140kg	1200mm	5.6kg



CANTILEVER KIT

Part code	Description	Height or equivalent	Width or equivalent	Length or equivalent	Weight	*Safe working load
CA-450-KIT	Cantilever arm kit - 450mm	750mm	41mm	450mm	8kg	250kg per arm
CA-600-KIT	Cantilever arm kit - 600mm	750mm	41mm	600mm	9kg	190kg per arm
CA-750-HKIT	Cantilever arm kit - 750mm	750mm	41mm	750mm	8kg	250kg per arm
CA-900-KIT	Cantilever arm kit - 900mm	900mm	41mm	900mm	8kg	250kg per arm

CONDENSING TRAYS



LIGHTWEIGHT CONDENSATE TRAYS

These 100% rust-free, UV stabilised, rigid, reinforced PVC condensate collection trays will fit any make of bracket. At less than 1kg, they are much easier to handle than metal trays and the tapered outlet fits a 16mm or 18mm hose pipe.



BASIC COLOUR RAL 7032

Part code	Description	Width	Length
CCT-790	Lightweight tray - small	390mm	790mm
CCT-940	Lightweight tray - large	420mm	940mm

METAL CONDENSATE TRAYS

BASIC COLOUR RAL 7032

These metal trays have a convex profile and a recessed surface flush, drain hose adaptor, minimising the amount of standing water left in the tray. Supplied with fixing arms for mounting to all Pump House brackets. For improved corrosion resistance all metal now receives a 100% zinc plating, followed by a hard ED coating, before being finished with an external grade polyester powder coating to RAL 7032.



Part code	Description	Width	Length	Depth	Weight
CCTM-800	Metal tray - small	400mm	800mm	25mm	5.23kg
CCTM-1080	Metal tray - 1080mm	500mm	1080mm	25mm	7.5kg
CCTM-1100	Metal tray - medium	400mm	1100mm	25mm	6.9kg
CCTM-1300	Metal tray - 1300mm	550mm	1300mm	25mm	8.8kg
CCTM-1400	Metal tray - large	400mm	1400mm	25mm	8.3kg

Part code	Description	Width	Length	Depth
CCTM-1420-BL	Metal tray	1420mm	500mm	25mm

FLOOR BRACKET KIT

When units are mounted at floor level, condensate discharge needs to be directed towards a drain or soakaway to avoid condensate causing a slip hazard. This floor bracket kit allows the metal tray to be mounted onto a flexi foot kit. The ASHP can then be mounted onto the bracket.



Part code	Description	For use with	Pack qty
CCTM-FLOOR-BRKT-KIT	Stainless steel brackets with fixings	Flexi Feet / trays	4
CCTM-FLOOR-BRKT-KIT-3	Stainless steel brackets with fixings (3 foot version)	Flexi Feet / trays	4

INABA DENKO TRUNKING

The range of Inaba Denko internal and external trunking will ensure that the air conditioning refrigeration pipes are protected with a professional finish. The three colours - black, ivory and white will match most brands of condensing units available, UV resistant, fire proof and can be painted to suit many indoor and outdoor applications. **Now available in anthracite!**

STRAIGHT DUCT



Part code	Description
ID-NSD-100-I	Slimduct - 100mm - 2000mm - Ivory
ID-NSD-100-W	Slimduct - 100mm - 2000mm - White
ID-SD-100-K	Slimduct - 100mm - 2000mm - Black
ID-SD-100-B	Slimduct - 100mm x 2000mm - Brown
ID-SD-100-A	Slimduct - 100mm - 2000mm - Anthracite
ID-NSD-75-I	Slimduct - 75mm - 2000mm - Ivory
ID-NSD-75-W	Slimduct - 75mm - 2000mm - White
ID-SD-75-K	Slimduct - 75mm - 2000mm - Black
ID-SD-75-B	Slimduct - 75mm - 2000mm - Brown
ID-SD-75-A	Slimduct - 75mm - 2000mm - Anthracite

90° VERTICAL ELBOW



Part code	Description
ID-SC-100-I	Slimduct - 100mm Elbow Bend - Ivory
ID-SC-100-W	Slimduct - 100mm Elbow Bend - White
ID-SC-100-K	Slimduct - 100mm Elbow Bend - Black
ID-SC-100-A	Slimduct - 100mm Elbow Bend - Anthracite
ID-SC-75-I	Slimduct - 75mm Elbow Bend - Ivory
ID-SC-75-W	Slimduct - 75mm Elbow Bend - White
ID-SC-75-K	Slimduct - 75mm Elbow Bend - Black
ID-SC-75-B	Slimduct - 75mm Elbow Bend - Brown
ID-SC-75-A	Slimduct - 75mm Elbow Bend - Anthracite

COUPLER



Part code	Description
ID-SJ-100-I	Slimduct - 100mm Connection Piece - Ivory
ID-SJ-100-W	Slimduct - 100mm Connection Piece - White
ID-SJ-100-K	Slimduct - 100mm Connection Piece - Black
ID-SJ-100-B	Slimduct - 100mm Connection Piece - Brown
ID-SJ-100-A	Slimduct - 100mm Connection Piece - Anthracite
ID-SJ-75-I	Slimduct - 75mm Connection Piece - Ivory
ID-SJ-75-W	Slimduct - 75mm Connection Piece - White
ID-SJ-75-K	Slimduct - 75mm Connection Piece - Black
ID-SJ-75-B	Slimduct - 75mm Connection Piece - Brown
ID-SJ-75-A	Slimduct - 75mm Connection Piece - Anthracite

AVAILABLE IN



INABA DENKO TRUNKING

FLEXIBLE JOINT



Part code	Description
ID-SF-100-800-I	Slimduct - 100mm - 800mm Flexible Joint - Ivory
ID-SF-100-800-W	Slimduct - 100mm - 800mm Flexible Joint - White
ID-SF-100-800-K	Slimduct - 100mm - 800mm Flexible Joint - Black
ID-SF-100-800-B	Slimduct - 100mm - 800mm Flexible Joint - Brown
ID-SF-100-800-A	Slimduct - 100mm - 800mm Flexible Joint - Anthracite
ID-SF-75-500-I	Slimduct - 75mm - 500mm Flexible Joint - Ivory
ID-SF-75-500-W	Slimduct - 75mm - 500mm Flexible Joint - White
ID-SF-75-500-K	Slimduct - 75mm - 500mm Flexible Joint - Black
ID-SF-75-500-B	Slimduct - 75mm - 500mm Flexible Joint - Brown
ID-SF-75-500-A	Slimduct - 75mm - 500mm Flexible Joint - Anthracite
ID-SF-75-1000-A	Slimduct - 75mm - 1000mm Flexible Joint - Anthracite

90° FLAT ELBOW



Part code	Description
ID-SK-100-I	Slimduct - 100mm 90 Degree Flat Bend - Ivory
ID-SK-100-W	Slimduct - 100mm 90 Degree Flat Bend - White
ID-SK-100-K	Slimduct - 100mm 90 Degree Flat Bend - Black
ID-SK-100-B	Slimduct - 100mm 90 Deg Flat Bend - Brown
ID-SK-100-A	Slimduct - 100mm 90 Deg Flat Bend - Anthracite
ID-SK-75-I	Slimduct - 75mm 90 Degree Flat Bend - Ivory
ID-SK-75-W	Slimduct - 75mm 90 Degree Flat Bend - White
ID-SK-75-K	Slimduct - 75mm 90 Degree Flat Bend - Black
ID-SK-75-B	Slimduct - 75mm 90 Deg Flat Bend - Brown
ID-SK-75-A	Slimduct - 75mm 90 Deg Flat Bend - Anthracite

45° FLAT ELBOW



Part code	Description
ID-SKF-100-I	Slimduct - 100mm 45 Degree Flat Bend - Ivory
ID-SKF-100-W	Slimduct - 100mm 45 Degree Flat Bend - White
ID-SKF-100-K	Slimduct - 100mm 45 Degree Flat Bend - Black
ID-SKF-100-B	Slimduct - 100mm 45 Deg Flat Bend - Brown
ID-SKF-100-A	Slimduct - 100mm 45 Deg Flat Bend - Anthracite
ID-SKF-75-I	Slimduct - 75mm 45 Degree Flat Bend - Ivory
ID-SKF-75-W	Slimduct - 75mm 45 Degree Flat Bend - White
ID-SKF-75-K	Slimduct - 75mm 45 Degree Flat Bend - Black
ID-SKF-75-B	Slimduct - 75mm 45 Deg Flat Bend - Brown
ID-SKF-75-A	Slimduct - 75mm 45 Deg Flat Bend - Anthracite

AVAILABLE IN



INABA DENKO TRUNKING

JOINT



Part code	Description
ID-ST-100-I	Slimduct - 100mm T Joint - Ivory
ID-ST-100-W	Slimduct - 100mm T Joint - White
ID-ST-100-K	Slimduct - 100mm T Joint - Black
ID-ST-100-B	Slimduct - 100mm T-Joint - Brown
ID-ST-75-I	Slimduct - 75mm T Joint - Ivory
ID-ST-75-W	Slimduct - 75mm T Joint - White
ID-ST-75-K	Slimduct - 75mm T Joint - Black
ID-ST-75-B	Slimduct - 75mm T-Joint - Brown

WALL INLET



Part code	Description
ID-SW-100-I	Slimduct - 100mm Wall Cover - Ivory
ID-SW-100-W	Slimduct - 100mm Wall Cover - White
ID-SW-100-K	Slimduct - 100mm Wall Cover - Black
ID-SW-100-B	Slimduct - 100mm Wall Cover - Brown
ID-SW-100-A	Slimduct - 100mm Wall Cover - Anthracite
ID-SW-75-I	Slimduct - 75mm Wall Cover - Ivory
ID-SW-75-W	Slimduct - 75mm Wall Cover - White
ID-SW-75-K	Slimduct - 75mm Wall Cover - Black
ID-SW-75-B	Slimduct - 75mm Wall Cover - Brown
ID-SW-75-A	Slimduct - 75mm Wall Cover - Anthracite

WALL ROSETTE



Part code	Description
ID-SWC-100-I	Slimduct - 100mm Wall Rosette - Ivory
ID-SWC-100-W	Slimduct - 100mm Wall Rosette - White
ID-SWC-100-K	Slimduct - 100mm Wall Rosette - Black
ID-SWC-100-B	Slimduct - 100mm Wall Rosette - Brown
ID-SWC-75-I	Slimduct - 75mm Wall Rosette - Ivory
ID-SWC-75-W	Slimduct - 75mm Wall Rosette - White
ID-SWC-75-K	Slimduct - 75mm Wall Rosette - Black
ID-SWC-75-B	Slimduct - 75mm Wall Rosette Brown

45° VERTICAL ELBOW



Part code	Description
ID-SCF-100-I	Slimduct - 100mm 45 Degree Elbow Bend - Ivory
ID-SCF-100-W	Slimduct - 100mm 45 Degree Elbow Bend - White
ID-SCF-100-K	Slimduct - 100mm 45 Degree Elbow Bend - Black
ID-SCF-100-B	Slimduct - 100mm 45 Deg Elbow Bend - Brown
ID-SCF-75-I	Slimduct - 75mm 45 Degree Elbow Bend - Ivory
ID-SCF-75-W	Slimduct - 75mm 45 Degree Elbow Bend - White
ID-SCF-75-K	Slimduct - 75mm 45 Degree Elbow Bend - Black
ID-SCF-75-B	Slimduct - 75mm 45 Deg Elbow Bend - Brown

INABA DENKO TRUNKING

DUCT END



Part code	Description
ID-SEN-100-I	Slimduct - 100mm Duct End - Ivory
ID-SEN-100-W	Slimduct - 100mm Duct End - White
ID-SEN-100-K	Slimduct - 100mm Duct End - Black
ID-SEN-100-B	Slimduct - 100mm Duct End - Brown
ID-SEN-100-A	Slimduct - 100mm Duct End - Anthracite
ID-SE-75-I	Slimduct - 75mm Duct End - Ivory
ID-SE-75-W	Slimduct - 75mm Duct End - White
ID-SE-75-K	Slimduct - 75mm Duct End - Black
ID-SE-75-B	Slimduct - 75mm Duct End - Brown
ID-SE-75-A	Slimduct - 75mm Duct End - Anthracite

OFFSET BEND



Part code	Description
ID-SIF-75-I	Slimduct - 75mm Offset bend - Ivory
ID-SIF-75-W	Slimduct - 75mm Offset bend - White
ID-SIF-75-K	Slimduct - 75mm Offset bend - Black
ID-SIF-75-B	Slimduct - 75mm Offset bend - Brown
ID-SIF-100-I	Slimduct - 100mm Offset bend - Ivory
ID-SIF-100-W	Slimduct - 100mm Offset bend - White
ID-SIF-100-K	Slimduct - 100mm Offset bend - Black
ID-SIF-100-B	Slimduct - 100mm Offset bend - Brown

CEILING COVER



Part code	Description
ID-SP-100-I	Slimduct - 100mm Flat Rosette Ivory
ID-SP-100-W	Slimduct - 100mm Flat Rosette White
ID-SP-100-K	Slimduct - 100mm Flat Rosette Black
ID-SP-100-B	Slimduct - 100mm Flat Rosette Brown
ID-SP-100-A	Slimduct - 100mm Flat Rosette - Anthracite
ID-SP-75-I	Slimduct - 75mm Flat Rosette Ivory
ID-SP-75-W	Slimduct - 75mm Flat Rosette White
ID-SP-75-K	Slimduct - 75mm Flat Rosette Black
ID-SP-75-B	Slimduct - 75mm Flat Rosette Brown
ID-SP-75-A	Slimduct - 75mm Flat Rosette - Anthracite

REDUCER



Part code	Description
ID-SDR-100-75-I	Slimduct - 100-75mm Reducer Joint - Ivory
ID-SDR-100-75-W	Slimduct - 100-75mm Reducer Joint - White
ID-SDR-100-75-K	Slimduct - 100-75mm Reducer Joint - Black

AVAILABLE IN



BLACK WHITE IVORY BROWN ANTHRACITE

TRUNKING

INABA DENKO TRUNKING

BIG TIE



Part code	Description
ID-BT-250	Bigtie - 250mm
ID-BT-350	Bigtie - 350mm

TIE CLIP KIT



Part code	Description
ID-SL-300	Slimduct - Tie Clip

DRAIN HOSE



Part code	Description
ID-DH-14	Drain Hose - Ivory-14mm (20mm box)
ID-DH-16	Drain Hose - Ivory-16mm (20mm box)

SLIM DUCT CUTTER



Part code	Description
ID-VD-2100	Slim Duct Cutter

AVAILABLE IN



SPEEDICHANNEL TRUNKING

SpeediChannel® is a system used to house air conditioning refrigerant pipes and services. Made out of rigid PVC, the colours are fadeproof, UV resistant and fireproof. The trunking contributes to reducing energy consumption. Suitable for indoor and outdoor use, it can be painted to match its environment.

DUCT



Description	Width	Ivory Part code	White Part code
Duct - 70mm - sold in 2 metre lengths	70mm	230-D3	230-D3W
Duct - 105mm - sold in 2 metre lengths	105mm	230-D4	230-D4W

INSIDE ELBOW

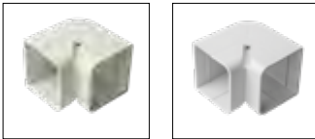

Description	Width	Ivory Part code	White Part code
Inside Elbow 90 Degree	70mm	230-EB3	230-EB3W
Inside Elbow 90 Degree	105mm	230-EB4	230-EB4W

OUTSIDE ELBOW

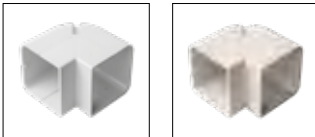

Description	Width	Ivory Part code	White Part code
Outside Elbow 90 Degree	70mm	230-EIN3	230-EIN3W
Outside Elbow 90 Degree	105mm	230-EIN4	230-EIN4W

FLAT BEND

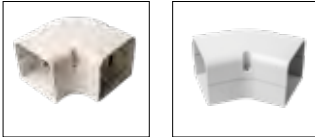

Description	Width	Ivory Part code	White Part code
Flat Bend 90 Degree	70mm	230-FB3	230-FB3W
Flat Bend 90 Degree	105mm	230-FB4	230-FB4W
Flat Bend 45 Degree	70mm	230-FB453	230-FB453W
Flat Bend 45 Degree	105mm	230-FB454	230-FB454W
Adjust Flat Bend 45-90 Degree	70mm	230-AFB3	230-AFB3W
Adjust Flat Bend 45-90 Degree	105mm	230-AFB4	230-AFB4W

FLAT ROSETTE

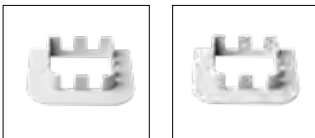

Description	Width	Ivory Part code	White Part code
Flat Rosette	70mm	230-FR3	230-FR3W
Flat Rosette	105mm	230-FR4	230-FR4W

FLAT ELBOW



Description	Width	Ivory Part code	White Part code
Long Flat Elbow 90 Degree	70mm	230-LFB3	230-LFB3W
Long Flat Elbow 90 Degree	105mm	230-LFB4	230-LFB4W

AVAILABLE IN



WHITE IVORY

SPEEDICHANNEL TRUNKING

AVAILABLE IN



WHITE IVORY

DUCT CAP



Description	Width	Ivory Part code	White Part code
Duct Cap	70mm	230-DC3	230-DC3W
Duct Cap	105mm	230-DC4	230-DC4W
Duct End	70mm	230-DE3	230-DE3W
Duct End	105mm	230-DE4	230-DE4W

CONNECTION PIECE



Description	Width	Ivory Part code	White Part code
Connection Piece	70mm	230-CP3	230-CP3W
Connection Piece	105mm	230-CP4	230-CP4W

JOINTS

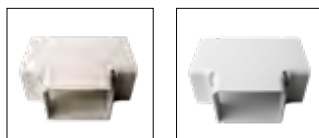

Description	Width	Ivory Part code	White Part code
Reducer Joint	105mm	230-RJ4	230-RJ4W
T Joint	105mm	230-TJ4	230-TJ4W

SOFFIT INLET

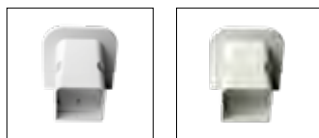

Description	Width	Ivory Part code	White Part code
Soffit Inlet	70mm	230-SF3	230-SF3W
Soffit Inlet	105mm	230-SF4	230-SF4W

WALL COVER

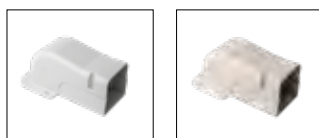

Description	Width	Ivory Part code	White Part code
Wall Cover	70mm	230-WC3	230-WC3W
Wall Cover	105mm	230-WC4	230-WC4W

WALL ROSETTE



Description	Width	Ivory Part code	White Part code
Wall Rosette	70mm	230-WR3	230-WR3W
Wall Rosette	105mm	230-WR4	230-WR4W

FLEXIBLE HOSE KIT



Description	Width	Ivory Part code	White Part code
Flexible Hose Kit	70mm	230-FH3-KIT	230-FH3W-KIT
Flexible Hose Kit	105mm	230-FH4-KIT	230-FH4W-KIT

MOUNTING BLOCKS

These mounting blocks are lightweight, 100% rust-free, UV stabilised and manufactured from reinforced PVC. Suitable for mounting air conditioning units and domestic air source heat pumps.

The blocks reduce vibration and are supplied with anti-slip strips on the base along with fixings for a simple rapid installation. End caps are available to provide a professional finish. CMB-350 & CMB-450 are sold in boxes of 12.

CMB-1000 are sold in pairs.

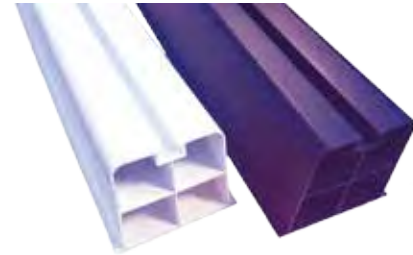

Part code (Black)	Part code (White)	Description	Dimensions mm (HxWxL)	Weight	"Safe Working Load**"
CMB-350		Mounting Blocks - 350mm	100x100x350	0.6kg	240kg
CMB-450	CMB-450-W	Mounting Blocks - 450mm	100x100x450	0.7kg	240kg
CMB-1000	CMB-1000-W	Mounting Blocks - 1000mm	100x100x1000	1.6kg	240kg

RUBBER AND CORK MOUNTING STRIPS (AND PADS)

Anti-vibration mounting strips / pads are a low cost option for mounting air conditioning units, air source heat pumps and other equipment, providing vibration reduction and sound dampening.

Available in recycled rubber and cork-rubber in various sizes. Rubber AVM Pad comes in three sizes (steel plates are in the larger sizes).



ANTI VIBRATION MOUNTING STRIPS

Part code	Description	Dimensions mm (WxL)	Thickness mm	Weight
AVMS-1	Anti-vibration Mounting Strip - Rubber	50x500	15	0.4kg
AVMS-2	Anti-vibration Mounting Strip - Rubber	75x1000	15	1kg
AVMS-3	Anti-vibration Mounting Strip - Rubber	75x1200	15	1.7kg
AVMS-4	Anti-vibration Mounting Strip - Rubber	100x1000	15	1.4kg
AVMS-CR-3	Anti-vibration Mounting Strip - Cork/Rubber	75x1200	12.5	0.8kg
AVMS-CR-4	Anti-vibration Mounting Strip - Cork/Rubber	100x1200	12.5	0.9kg

Part code	Description	Dimensions mm (HxWxL)	Weight	Safe Working Load*
AVM-PAD-1	Rubber AVM Pad - 330mm	45x300x300	3.2kg	200kg
AVM-PAD-2	Rubber AVM Pad - 600mm with steel plates	30x105x 600	2.8kg	150kg
AVM-PAD-3	Rubber AVM Pad - 1000mm with steel plates	30x500x1000	22kg	300kg

MOUNTING



FLEXI LITE SLAB AND FOOT KIT

A low cost, lightweight floor mounting solution for air conditioning equipment and air source heat pumps.

Easy to transport, locate and construct.

The kit comes complete with two anti-vibration feet, a lightweight slab and all the fixings

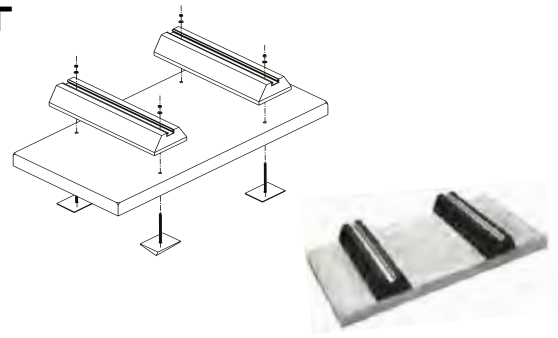

Part code	Description	Specifications
FF-UC3-S	Flexi Lite Kit - small	900 x 600 x 175
FF-UC3-M	Flexi Lite Kit - medium	1050 x 600 x 175
FF-UC3	Flexi-Lite Slab Kit	1200 x 600 x 175
FF-UC3-3	Flexi lite Slab Kit - 3 FEET	1200 x 600 x 175
FF-UC3-XL	Flexi-Lite Slab Kit - extra large	1525 x 915 X 75
FF-UC3-3XL	Flexi-Lite Slab Kit - 3 FEET - extra large	1650 x 865 x 175
FF-UC3-3XL-150	Flexi-Lite Slab Kit - 3 FEET (150mm feet) - extra large	1650 x 865 x 225



SMALL



MEDIUM



LARGE



EXTRA LARGE



3-FOOT



ULTRALITE® SLAB

Don't be fooled - Ultralite® Slabs look and perform like a concrete slab, starting at only 7kg, they are lightweight and very easy to handle and transport. So give your aching back a rest and use Ultralite® slabs to mount AC units and air source heat pumps.

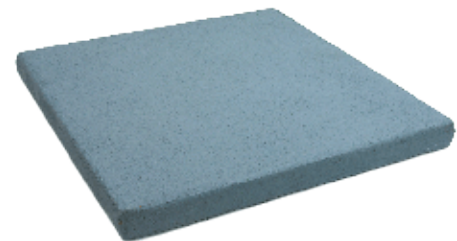

Part code	Description	Dimensions mm (HxWxD)	Weight	Safe working load*
UC1636-3	Ultralite equipment pad	75x400x900	7kg	300kg
UC2424-3	Ultralite equipment pad	75x600x600	7kg	300kg
UC2436-3	Ultralite equipment pad	75x600x900	12kg	485kg
UC2442-3	Ultralite equipment pad	75x600x1050	16kg	595kg
UC2448-3	Ultralite equipment pad	75x600x1200	16kg	700kg

QUICK SLING®

Quick Sling stands offer light and easy-assembly support for outdoor a/c condensing units and heat pumps. Ideal for raising the condensing unit height in surface installations. The elevated height allows for ease of installation, maintenance and service. Available in three height options.

- Flat-packed for easy handling, transport and storage
- Quick and easy to assemble
- Adjustable to suit outdoor units with fixing feet centres up to 700mm (L) and 430mm (W)
- Each 150mm square foot is height adjustable (up to 30mm) to accommodate uneven surfaces
- Includes anti-vibration mounting bolts
- Epoxy powder coated finish



Part code	Description	Length mm	Width mm	Height mm	"Safe Working Load"	Weight
QSMS1201	Quick Sling Stand - Low	1056	941	305	180kg	10kg
QSMS1801	Quick Sling Stand - Medium	1056	941	450	180kg	13kg
QSMS2401	Quick Sling Stand - High	1056	941	600	180kg	16kg

MOUNTING



EVA™ PADS / CORK RUBBER ANIT-VIBRATION PADS

EVA™ anti-vibration pads are designed to effectively eliminate vibrations and reduce noise levels from equipment such as compressors, condensing units and air source heat pumps. Out performing cork and rubber by 3:1, the EVA pad has a special composite foam centre and is resistant to most oils & chemicals.

The cork is laminated between two corrugated pads to reduce vibration and noise. Designed to withstand 3.5kg per cm³. Ideal for air conditioners, compressors, cooling towers or anywhere where vibration control is needed.

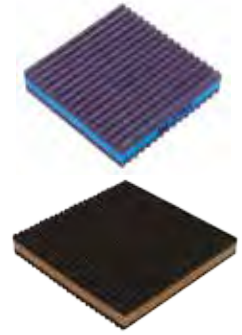

Part code EVA	Part code Cork / Rubber ^{''}	Description	Dimensions mm (HxWxL)	Weight	Safe Working Load*
MP-2E	MP-2C	Pad - 50mm	20x50x50	0.04kg	3.5kg per cm ²
MP-3E	MP-3C	Pad - 80mm	20x80x80	0.08kg	3.5kg per cm ²
MP-4E	MP-4C	Pad - 100mm	20x100x100	0.1kg	3.5kg per cm ²
MP-6E	MP-6C	Pad - 150mm	20x150x150	0.3kg	3.5kg per cm ²
MP-12E	MP-12C	Pad - 305mm	20x305x305	1.4kg	3.5kg per cm ²
MP-18E	MP-18C	Pad - 460mm	20x460x460	3kg	3.5kg per cm ²

RUBBER ANTI-VIBRATION PAD

Highest quality oil resistant pads, designed to withstand 3.5kg per cm³. The rubber pads are corrugated on both sides. Ideal for air conditioners, compressors or anywhere where vibration control is needed.



Part code	Description	Dimensions mm (HxWxL)	Weight	Safe Working Load*
MP-2	Rubber Anti-vibration Pad - 50mm	9.5x50x50	0.04kg	3.5kg per cm ²
MP-3	Rubber Anti-vibration Pad - 80mm	10x80x80	0.05kg	3.5kg per cm ²
MP-4	Rubber Anti-vibration Pad - 100mm	10x100x100	0.1kg	3.5kg per cm ²
MP-6	Rubber Anti-vibration Pad - 150mm	10x150x150	0.2kg	3.5kg per cm ²
MP-18	Rubber Anti-vibration Pad - 460mm	10x460x460	1.8kg	3.5kg per cm ²

ISO-CUBE ANTI-VIBRATION PADS

Natural rubber pads, designed to reduce vibration and noise emanating from refrigeration and air conditioning equipment. The circular design in each pad offers a suction cup effect, which eliminates the need to bolt the pads down. A standard 18" (46cm) pad is divided into eighty-one 2" (5cm) segments, each of which may be cut or torn to provide smaller pads.



Part code	Description	Dimensions mm (HxWxL)	Weight	Safe Working Load*
ISO-4	ISO Cube Natural Rubber Pads - 100mm	20x100x100	0.18kg	12.6kg per cm ²
ISO-18	ISO Cube Natural Rubber Pads - 460mm	20x460x460	3.8kg	12.6kg per cm ²

PAC-IHP-12-BLK

The all new PORTABLE AC (heat & cool) is now available in a sleek black finish. This unit has a A++ cooling energy class rating, and when winter arrives, the heating output has an A+++ heating energy class.

- NEW black colour
- A++ cooling energy class rating
- A+++ heating energy class rating
- Uses 25% less power than non inverter unit
- R290 refrigerant

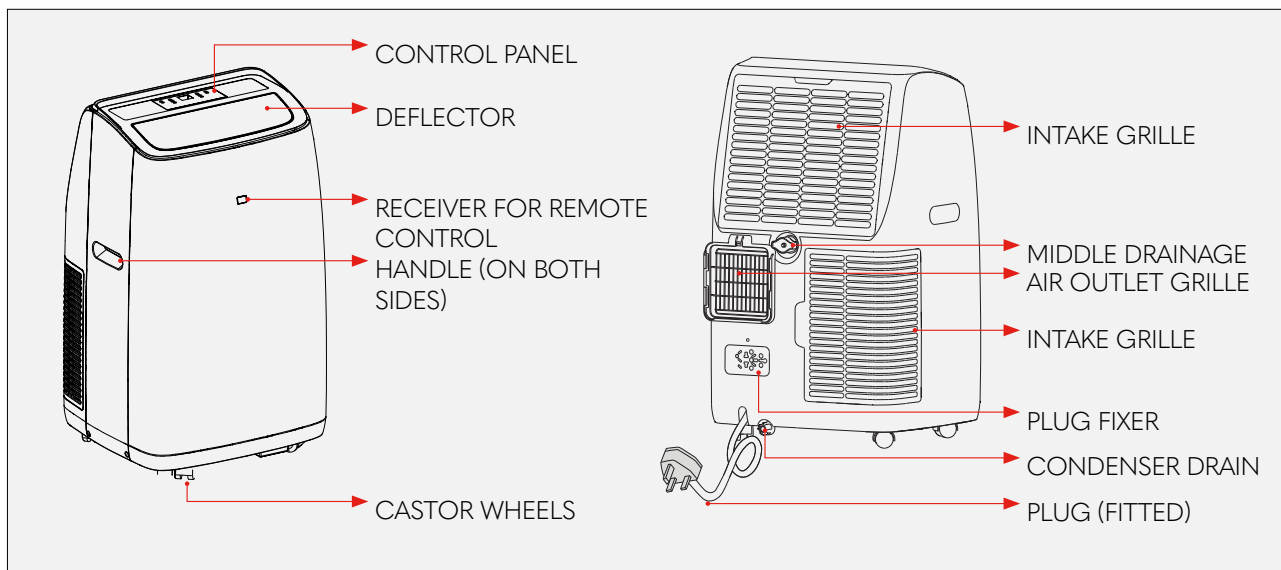

power supply	220-240V - 50hz
water tank volume	1.2L
cooling capacity	3500W
cooling energy class	A++
heating capacity	2930W
heating energy class	A+++
moisture removal	1.6 LPH
SOUND	64/63/62 dB(A) (58 dB(A) sleep)
refrigerant	R290
charge	0.23kg

gwp	3
CO2	0.00069
suction pressure	1.2 Mpa
discharge pressure	2.3 Mpa
rated power	1100W
rated current	6.8A
Weight	31.1kg
gross weight	35.3kg
dimensions	450 (W) x 396 (D) x 745 (H)mm
packing dimensions	499 (W) x 459 (D) x 880 (H)mm

PORTABLES



PORTABLES - COOL ONLY & HEAT / COOL PUMP

A energy efficiency

The portable air conditioners are suitable for offices, computer rooms and light commercial use. The cooling only model is ideal for cooling flats, conservatories or loft conversions during hot summer months. The heat and cool model can be used as an energy efficient form of heating along with cooling. The units come with a hose, tray, remote control and wall kit. Spare parts are available upon request - please enquire for more details.



PAC-C-12-R290

Part code	Description	Cool capacity Btu/kW	Heat capacity Btu/kW	Watts	Amps	Air flow volume	EER	COP	Sound power level dBA
PAC-C-12-R290	Portable (cooling)	12,000 / 3.5	N/A	1350	5.9	420m ³ /h	2.6	N/A	56
PAC-H-12-R290	Portable (heat pump)	12,000 / 3.5	N/A	1350	5.9	420m ³ /h	2.6	N/A	56

Part code	Description	Height	Width	Depth	Weight	Hose length	Refrigerant	Cooling area
PAC-C-12-R290	Portable (cooling)	730mm	485mm	360mm	28kg	1.5m	R290	25-30m ²
PAC-H-12-R290	Portable (heat pump)	730mm	485mm	360mm	28kg	1.5m	R290	25-30m ²

WALL AIR CONDITIONER

Wall air conditioners, also known as through-the-wall or in-wall air conditioners, are designed to be a long-lasting fixture. These 12,000 btu 3.5kW air conditioners are mounted into a hole in the wall as a permanent installation. Meets EN14511 standard and EU commission regulation 206/2012. R32 Refrigerant. Supplied with remote controller, this proven, well tested design is suitable for areas up to 23m³.



Part code	Description	Cool Capacity Btu / kW	Watts	Amps	Air Flow Volume
WAC-C-12-INV	Through-the-wall AC	12,000 / 3.5	1100	5.1	400m ³ /h

Part code	Description	Height	Width	Depth	Weight	Refrigerant	Cooling Area
WAC-C-12-INV	Through-the-wall AC	400mm	560mm	670mm	42kg	R32	16-23m ²

UNIVERSAL REMOTE CONTROLLER

This universal air-conditioning remote controller is compatible with units from all major air conditioning manufacturers. This easy to use, time saving tool is perfect for maintaining and servicing any air conditioning unit.



Part code	Max range	Batteries	Length	Width	Height	Weight
KT-1028	8m	AAA x 2	130mm	46mm	16mm	50g

CUSHION CLAMPS

Cushion Clamps are the industry established method of supporting copper refrigerant tube, especially for multiple pipe runs. The zinc dichromate plating provides excellent corrosion resistance and the polymer insert ensures a positive grip, absorbs shock and vibration and prevents galvanic corrosion.



Part code	Pipe Diameter	Pack qty	Part code	Pipe Diameter	Pack qty
CC-004	1/4	10	CC-022	1-3/8	10
CC-006	3/8	10	CC-026	1-5/8	10
CC-008	1/2	10	CC-034	2-1/8	5
CC-010	5/8	10	CC-042	2-5/8	5
CC-012	3/4	10	CC-050	3-1/8	5
CC-014	7/8	10	CC-058	3-5/8	5
CC-018	1-1/8	10	CC-066	4-1/8	5

THREADED ROD HANGERS

These clamps support a pair of flow and return insulated copper air conditioning pipes on either M8 or M10 threaded rod. By simply squeezing the tips together, the spring steel rod hanger can be fitted or adjusted in seconds, even after the refrigerant pipes have been installed. Black zinc coating matches the insulation colour and offers corrosion resistance.



Part code	Description	Liquid Pipe Diameter (inches)	Gas Pipe Diameter (inches)	Threaded Rod Diameter (inches)	Pack QTY
TRH-1	Threaded Rod Hanger - Size 1	1/4	1/2	M8/M10	10
TRH-2	Threaded Rod Hanger - Size 2	3/8	5/8	M8/M10	10
TRH-3	Threaded Rod Hanger - Size 3	1/2	7/8	M8/M10	10
TRH-4	Threaded Rod Hanger - Size 4	5/8	1-1/8	M8/M10	10

GRIP FIT CLAMPS

The asymmetric design provides a perfect fit for any one of four pairs of flow and return insulated refrigerant pipes. An 8mm hole allows the clamps to be fixed directly to any flat surface, such as a wall or ceiling. The hinged design allows the product to be installed quickly.



Part code	Description	Liquid Pipe Diameter (inches)	Gas Pipe Diameter (inches)	Pack QTY
GFC-1	Grip Fit Clamp - Size 1	1/4	1/2	10
GFC-2	Grip Fit Clamp - Size 2	3/8	5/8	10
GFC-3	Grip Fit Clamp - Size 3	1/2	7/8	10
GFC-4	Grip Fit Clamp - Size 4	5/8	1-1/8	10

CLAMPS AND CLIPS



BACK PLATE 810-HD

Back plate for mounting M8/M10 threaded rod. Secure threaded rod to a wall or ceiling safely.

Our Back Plate is used for Mounting M8 / M10 Threaded Rod safely to a wall or ceiling. Made from zinc plated steel, this back plate has a thickness of 3mm and comes in a box of 50.



Part code	Description	Material	Length	Width	Quantity
BackPlate-810-HD	Back Plate for Mounting M8/M10 Threaded Rod	2.5mm Zinc Plated Steel	80	30	50

K-KLAMP - PIPE AND INSULATION CLAMP

K-KLAMP eliminates having to double-wrap, glue and tape the insulation on strut-mounted clamps. K-KLAMP pipe and insulation coupling reduces the time required to insulate copper tubing used for refrigerant lines. Our clamp allows sections of closed-cell insulation to be secured at fixing points.



Part code	Insulation wall thickness			
	3/8"	1/2"	3/4"	1"
1/4"	K38-14	-	K34-14	-
3/8"	K38-38	K12-38	K34-38	-
1/2"	K38-12	K12-12	K34-12	K100-12
5/8"	K38-58	K12-58	K34-58	K100-58
3/4"	K38-34	K12-34	K34-34	K100-34
7/8"		K12-78	K34-78	K100-78
1"	K38-100	K12-100	-	-
1-1/8"	K38-118	K12-118	K34-118	K100-118
1-3/8"	K38-138	K12-138	K34-138	K100-138
1-5/8"	K38-158	K12-158	K34-158	K100-158
2-1/8"		K12-218	K34-218	K100-218
2-5/8"	-	K12-258	K34-258	K100-258
3-1/8"	-	K12-318	K34-318	K100-318
3-5/8"	-	K12-358	K34-358	K100-358
4-1/8"	-	K12-418	K34-418	K100-418

Klo-Shure Part code	Discharge size (inches)
729037	Klo-Shure 3/8" ID x 1-1/2"
729050	Klo-Shure 1/2" ID x 1-1/2"
729062	Klo-Shure 5/8" ID x 1-1/2"
729087	Klo-Shure 7/8" ID x 1-1/2"
729112	Klo-Shure 1-1/8" ID x 1-1/2"
729137	Klo-Shure 1-3/8" ID x 1-1/2"
729162	Klo-Shure 1-5/8" ID x 1-1/2"
729212	Klo-Shure 2-1/8" ID x 1-1/2"
729262	Klo-Shure 2-5/8" ID x 1-1/2"
729312	Klo-Shure 3-1/8" ID x 1-1/2"
729412	Klo-Shure 4-1/8" ID x 1-1/2"

HINGED LINED PIPE CLAMP

These hinged lined pipe clamps are suitable for supporting all types of pipework including HVAC, boiler and drain. They come with noise suppressing rubber strips: 17dB(A) according to ISO 3822-1.



Part code	Description	Quantity
RLC-020-GS	Single Hinged Pipe Clamp M8-10 lined 3/8" 15-19mm	Box of 50
RLC-024-GS	Single Hinged Pipe Clamp M8-10 lined 1/2" 20-24mm	Box of 50
RLC-029-GS	Single Hinged Pipe Clamp M8-10 lined 3/4" 25-29mm	Box of 50
RLC-035-GS	Single Hinged Pipe Clamp M8-10 lined 1" 32-36mm	Box of 50
RLC-042-GS	Single Hinged Pipe Clamp M8-10 lined 1-1/4" 40-45mm	Box of 50
RLC-053-GS	Single Hinged Pipe Clamp M8-10 lined 1-1/2" 48-53mm	Box of 50
RLC-065-GS	Single Hinged Pipe Clamp M8-10 Lined 2" 58-63mm	Box of 50

RUBBER-LINED UNIVERSAL PIPE CLAMP

The M8-M10 rubber-lined pipe clamp are suitable for supporting all types of pipework including HVAC, boiler and drain. They come with noise suppressing rubber strips: 17dB(A) according to ISO 3822-1.



Part code	Description	Quantity
RLC-015	Pipe Clamp M8-10 Rubber lined 1/4" 11/15mm	Box of 50
RLC-020	Pipe Clamp M8-10 lined 3/8" 14-19mm	Box of 50
RLC-024	Pipe Clamp M8-10 lined 1/2" 20-24mm	Box of 50
RLC-029	Pipe Clamp M8-10 lined 3/4" 25-29mm	Box of 50
RLC-035	Pipe Clamp M8-10 lined 1" 32-36mm	Box of 50
RLC-044	Pipe Clamp M8-10 lined 1-1/4" 37-44mm	Box of 50
RLC-050	Pipe Clamp M8-10 lined 1-1/2" 44-50mm	Box of 50
RLC-058	Pipe Clamp M8-10 lined 50-58mm	Box of 50
RLC-068	Pipe Clamp M8-10 lined 2" 58-68mm	Box of 50
RLC-078	Pipe Clamp M8-10 lined 2-1/2" 68-78mm	Box of 50
RLC-088	Pipe Clamp M8-10 lined 78-88mm	Box of 50
RLC-098	Pipe Clamp M8-10 lined 3" 88-98mm	Box of 25
RLC-108	Pipe Clamp M8-10 lined 3-1/2" 98-108mm	Box of 25
RLC-118	Pipe Clamp M8-10 lined 4" 108-118mm	Box of 25
RLC-128	Pipe Clamp M8-10 lined 118-128mm	Box of 25
RLC-138	Pipe Clamp M8-10 lined 128-138mm	Box of 25
RLC-148	Pipe Clamp M8-10 lined 135-148mm	Box of 25
RLC-164	Pipe Clamp M8-10 lined 151-164mm	Box of 25
RLC-175	Pipe Clamp M8-10 lined 6" 165-175mm	Box of 10
RLC-185	Pipe Clamp M8-10 lined 175-185mm	Box of 10
RLC-205	Pipe Clamp M8-10 lined 194-205mm	Box of 10

CLAMPS AND CLIPS



RPC CHANNEL CLIPS

The RPC channel clip fits around the pipe and insulation. Ideal for multiple pipe runs, the one piece composite (nylon) alloy clamp absorbs shock and vibration. Quick and easy to install and suitable for temperatures -40°C to +140°C.



Part code	Description	Tube OD (inches)	Pack QTY
RPC-0014	RPC Channel Clip	1/4	10
RPC-0038	RPC Channel Clip	3/8	10
RPC-0012	RPC Channel Clip	1/2	10
RPC-0058	RPC Channel Clip	5/8	10
RPC-0034	RPC Channel Clip	3/4	10
RPC-0078	RPC Channel Clip	7/8	10
RPC-0118	RPC Channel Clip	1-1/8	10
RPC-0138	RPC Channel Clip	1-3/8	10
RPC-0158	RPC Channel Clip	1-5/8	10

RPC INSULCLIPS

The InsulClips allows an uninterrupted vapour seal and eliminates the problem of sweating on metal fittings. This makes the InsulClip the ideal product to secure the installation of the refrigerant pipes, allowing the vapour seal to run the length of the pipework without cutting the insulation material. Made from a composite polyamide (nylon) alloy, which has similar tensile strength properties to nylon but better impact strength, especially at low temperatures.



Part code	Tube OD (inches)	Pack QTY
IC00-15	5/8	10
IC00-20	3/4	10
IC00-22	7/8	10
IC00-25	1	10
IC00-28	1-1/8	10
IC00-32	1-1/4	10
IC00-35	1-3/8	10
IC00-40	1-1/2	10
IC00-42	1-5/8	10
IC00-50	2	10
IC00-54	2-1/8	10

RPC FLAT SURFACE MOUNT ADAPTOR (RPC-FB-B)



CLAMPS AND CLIPS



RPC STUDDING CLIPS

The studding clips from RPC have a unique way of attaching themselves to the threaded rod.

Simply insert the clip and snap to secure. The ratchet design locks the pipework in place. It will overcome the problems of using cable ties for piping, electrical, optical and network cabling.



Part code	Stud Size	Tube OD (inches)	Pack QTY
SC08-15	Studding Clip M8	5/8	10
SC08-20	Studding Clip M8	3/4	10
SC08-22	Studding Clip M8	7/8	10
SC08-25	Studding Clip M8	1	10
SC08-28	Studding Clip M8	1-1/8	10
SC08-32	Studding Clip M8	1-1/4	10
SC08-35	Studding Clip M8	1-3/8	10
SC08-40	Studding Clip M8	1-1/2	10
SC08-42	Studding Clip M8	1-5/8	10
SC08-50	Studding Clip M8	2	10
SC08-54	Studding Clip M8	2-1/8	10

Part code	Stud Size	Tube OD (inches)	Pack QTY
SC10-15	Studding Clip M10	5/8	10
SC10-20	Studding Clip M10	3/4	10
SC10-22	Studding Clip M10	7/8	10
SC10-25	Studding Clip M10	1	10
SC10-28	Studding Clip M10	1-1/8	10
SC10-32	Studding Clip M10	1-1/4	10
SC10-35	Studding Clip M10	1-3/8	10
SC10-40	Studding Clip M10	1-1/2	10
SC10-42	Studding Clip M10	1-5/8	10
SC10-50	Studding Clip M10	2	10
SC10-54	Studding Clip M10	2-1/8	10

Part code	Description	Tube OD (inches)	Pack QTY
SC06-15	M6 Stud Clip - 5/8"	5/8	10
SC06-20	M6 Stud Clip - 3/4"	3/4	10
SC06-22	M6 Stud Clip - 7/8"	7/8	10
SC06-25	M6 Stud Clip - 1"	1	10
SC06-28	M6 Stud Clip - 1-1/8"	1-1/8	10

Part code	Description	Tube OD (inches)	Pack QTY
SC06-32	M6 Stud Clip - 1-1/4"	1-1/4	10
SC06-35	M6 Stud Clip - 1-3/8"	1-3/8	10
SC06-40	M6 Stud Clip - 1-1/2"	1-1/2	10
SC06-42	M6 Stud Clip - 1-5/8"	1-5/8	10
SC06-50	M6 Stud Clip - 2"	2	10
SC06-54	M6 Stud Clip - 2-1/8"	2-1/8	10

RPC CABLE TIE CLIPS

Channel cable tie clips accommodate PVC or metal cable ties up to a width of 17mm. They come in three support base lengths of 50, 65 and 80mm. The channel clips are secured on the channel with a twist lock motion, ready for the cable tie to be inserted to secure the refrigeration pipework.

Clips can be used in temperatures ranging from -40 to 140°C. They have a melting point of 220°C. They can withstand pressures up to 40 MPa, with less than 4% deformation, and provide high resistance to mechanical stress creep. As well as resisting all known solvents, the clips have a low moisture sensitivity.

They also have stable electrical and vibration properties and a high resistance to UV light.

Part code	Size (mm)	Pack QTY
CTC-050	50	10
CTC-065	65	10
CTC-080	80	10



INSERT INTO CHANNEL



TWIST CLOCKWISE



LOCK TO SECURE

BRASS FITTINGS



SHORT MACHINE FLARE NUT



Part code	Size (inches)	Pack QTY
DN1-3	3/16	10
DN1-4	1/4	10
DN1-5	5/16	10
DN1-6	3/8	10
DN1-8	1/2	10
DN1-10	5/8	10
DN1-12	3/4	10
DN1-14	7/8	5

SHORT FORGED FLARE NUT



Part code	Size (inches)	Pack QTY
DNS4-4	1/4	10
DNS4-6	3/8	10
DNS4-8	1/2	10
DNS4-10	5/8	10
DNS4-12	3/4	10
DNS4-14	7/8	5

FLARE TEE



Part code	Size (inches)	Pack QTY
DT2-4	1/4	10
DT2-6	3/8	10
DT2-8	1/2	10
DT2-10	5/8	10

CAP



Part code	Size (inches)	Pack QTY
DN5-4	1/4	10
DN5-6	3/8	10

PLUG



Part code	Size (inches)	Pack QTY
DP2-4	1/4	10
DP2-6	3/8	10
DP2-8	1/2	10
DP2-10	5/8	10

FLARE AND MPT ELBOW



Part code	Size (inches)	Pack QTY
DE1-4B	1/4	10
DE1-6C	3/8	10
DE1-8D	1/2	10
DE1-12E	5/8	10

FLARE & MPT ELBOW



Part code	Size (inches)	Pack QTY
DE1-6B	3/8 x 1/4 MPT	10
DE1-6D	3/8 x 1/2 MPT	10
DE1-8E	1/2 x 3/4 MPT	10
DE1-10D	5/8 x 1/2 MPT	10
DE1-12D	3/4 x 1/2 MPT	10

FLARE UNION



Part code	Size (inches)	Pack QTY
DU2-4	1/4	10
DU2-6	3/8	10
DU2-8	1/2	10
DU2-10	5/8	10
DU2-12	3/4	10

R410A & R32 TRANSITIONAL FITTING



Part code	Size (inches)	Pack QTY
20128	5/16 x 1/4	1

FLARE UNION X MPT



Part code	Size (inches)	Pack QTY
DU1-4A	1/4 x 1/8 MPT	10
DU1-4B	1/4 x 1/4 MPT	10
DU1-6B	3/8 x 1/4 MPT	10
DU1-6C	3/8 x 3/8 MPT	10
DU1-6D	3/8 x 1/2 MPT	10
DU1-6E	3/8 x 3/4 MPT	10
DU1-8B	1/2 x 1/4 MPT	10
DU1-8C	1/2 x 3/8 MPT	10
DU1-8D	1/2 x 1/2 MPT	10
DU1-8E	1/2 x 3/4 MPT	10
DU1-10D	5/8 x 1/2 MPT	10
DU1-10E	5/8 x 3/4 MPT	10
DU1-12D	3/4 x 1/2 MPT	10
DU1-12E	3/4 x 3/4 MPT	10

FLARE X FLARE SWIVEL UNION



Part code	Size (inches)	Pack QTY
DUS4-4	1/4 x 1/4	10
DUS4-6	3/8 x 3/8	10
DUS4-8	1/2 x 1/2	10

FLARE X FPT UNION



Part code	Size (inches)	Pack QTY
DU3-6C	3/8 x 3/8 FPT	10
DU3-6D	3/8 x 1/2 FPT	10
DU3-8C	1/2 x 3/8 FPT	10
DU3-8D	1/2 x 1/2 FPT	10
DU3-10D	5/8 x 1/2 FPT	10
DU3-10E	5/8 x 3/4 FPT	10

ACCESS FITTINGS



VAU-24



VST-46



VST-44X



VA-3-346

Code	Description	Size (inches)	Pack QTY
VA-3-346	3-Way Solder Fitting	3/16 OD to 1/4 & 3/8	6
VA-34	Straight Solder Fitting	3/16 ODS x 1/4 ODF	6
VA-68	Straight Solder Fitting	3/8 ODS x 1/2 ODF	6
VAU-24	Half Union	1/8 MPT	6
VAU-45	Half Union	1/4 MPT	6
VAX-3	Extended Copper Tube Fitting	1/4 SAE Flare with 3/16 OD x 1/8 ID with 2inch tail	6
VAX-4	Extended Copper Tube Fitting	1/4 SAE Flare with 1/4 OD x 3/16 ID with 2inch tail	6
VAX-4B	Extended Copper Tube Fitting	1/4 SAE Flare with 1/4 OD x 3/16 ID with 2inch tail	100
VAX-4B-6	Extended Copper Tube Fitting	1/4 SAE Flare with 1/4 OD x 3/16 ID with 6inch tail	1
VAX-5	Extended Copper Tube Fitting	1/4 SAE Flare with 5/16 OD x 1/4 ID with 2inch tail	3
VAX-5-PH	Extended Copper Tube Fitting	5/16 SAE Flare (R410a) with 1/4 OD x 3/16 ID with 2inch tail	1
VAX-6	Extended Copper Tube Fitting	1/4 SAE Flare with 3/8 OD x 5/16 ID with 2inch tail	3
VC-4	SAE Flare Cap 1/4	Plain Cap	12
VC-4R	SAE Flare Cap 1/4	Cap with Core Remover	12
VS-4	Access Fitting - Female Flare	Female 1/4 SAE Swivel Nut w /Depressor x 1/4 SAE male flare	3
VST-4	Swivel Tee 1/4	1/4 SAE Flare x 1/4 SAE Flare on run x 1/4 Female Swivel on branch	3
VST-44	Swivel Tee 1/4	1/4 SAE Flare x 1/4 Female Swivel on run x 1/4 SAE Flare on branch	3
VST-4X	Swivel Tee 1/4	1/4 SAE Flare x 1/4 SAE Flare on run x 1/4 Female Swivel on branch	3
VST-44X	Swivel Tee 1/4	1/4 SAE Flare x 1/4 Female Swivel on run x 1/4 SAE Flare on branch	3
VTS-10	Solder Tee Fitting	5/8 ODS x 5/8 ODS on run with 1/4 SAE Male Flare on branch	3
VTS-46	Solder Tee Fitting	1/4 ODS x 1/4 ODS on run with 1/4 SAE Male Flare on branch	3
VTS-68	Solder Tee Fitting	3/8 ODS x 3/8 ODS on run with 1/4 SAE Male Flare on branch	3
VTS-810	Solder Tee Fitting	1/2 ODS x 1/2 ODS on run with 1/4 SAE Male Flare on branch	3
VUR-4	Full Union	1/4 OD SAE Flare x 1/4 SAE Flare with Cap	6
MSA-44	Adaptor - SAE Female to MNPT	1/4 SAE Female Swivel x 1/4 MNPT	2
VVC-1	Replacement Valve Core Tool		6
VCR-1	Core Removal Tool & Storer		1
VCR-T-1	Core Removal Tool		1

COPPER FITTINGS



90° ELBOW (CXC)

Part code	Size (inches)	Pack QTY
C235-0001-PH	1/4	100
C235-0002-PH	3/8	100
C235-0025-PH	1/2	100
C235-0050-PH	5/8	100
C235-0090-PH	3/4	50
C235-0100-PH	7/8	50
C235-0150-PH	1-1/8	25
C235-0215-PH	1-3/8	10
C235-0295-PH	1-5/8	10
C235-0390-PH	2-1/8	1
C235-0520-PH	2-5/8	1
C235-0650-PH	3-1/8	1
C235-0750-PH	3-5/8	1
C235-0850-PH	4-1/8	1



90° STREET ELBOW (FXC)

Part code	Size (inches)	Pack QTY
C254-0002-PH	3/8	100
C254-0025-PH	1/2	100
C254-0050-PH	5/8	100
C254-0090-PH	3/4	50
C254-0100-PH	7/8	25
C254-0150-PH	1-1/8	20
C254-0215-PH	1-3/8	10
C254-0295-PH	1-5/8	10
C254-0390-PH	2-1/8	1
C254-0520-PH	2-5/8	1
C254-0650-PH	3-1/8	1
C254-0750-PH	3-5/8	1
C254-0850-PH	4-1/8	1
C235-0850-PH	4-1/8	1



90° LONG TURN ELBOW (CXC)

Part code	Size (inches)	Pack QTY
C242-0001-PH	1/4	100
C242-0002-PH	3/8	100
C242-0025-PH	1/2	100
C242-0050-PH	5/8	50
C242-0090-PH	3/4	50
C242-0100-PH	7/8	25
C242-0150-PH	1-1/8	10
C242-0215-PH	1-3/8	10
C242-0295-PH	1-5/8	5
C242-0390-PH	2-1/8	1
C242-0520-PH	2-5/8	1
C242-0650-PH	3-1/8	1
C242-0750-PH	3-5/8	1
C242-0850-PH	4-1/8	1



90° LONG TURN STREET ELBOW (FXC)

Part code	Size (inches)	Pack QTY
C272-0002-PH	3/8	100
C272-0025-PH	1/2	100
C272-0050-PH	5/8	50
C272-0090-PH	3/4	50
C272-0100-PH	7/8	25
C272-0150-PH	1-1/8	10
C272-0215-PH	1-3/8	10
C272-0295-PH	1-5/8	5
C272-0390-PH	2-1/8	1
C272-0520-PH	2-5/8	1
C272-0650-PH	3-1/8	1
C272-0750-PH	3-5/8	1
C272-0850-PH	4-1/8	1
C242-0850-PH	4-1/8	1

COPPER FITTINGS



45° ELBOW (CXC)

Part code	Size (inches)	Pack QTY
C290-0002-PH	3/8	100
C290-0025-PH	1/2	100
C290-0050-PH	5/8	50
C290-0090-PH	3/4	50
C290-0100-PH	7/8	50
C290-0150-PH	1-1/8	25
C290-0215-PH	1-3/8	10
C290-0295-PH	1-5/8	10
C290-0390-PH	2-1/8	1
C290-0520-PH	2-5/8	1
C290-0650-PH	3-1/8	1
C290-0750-PH	3-5/8	1
C290-0850-PH	4-1/8	1



45° STREET ELBOW (FXC)

Part code	Size (inches)	Pack QTY
C295-0002-PH	3/8	100
C295-0025-PH	1/2	100
C295-0050-PH	5/8	50
C295-0090-PH	3/4	50
C295-0100-PH	7/8	25
C295-0150-PH	1-1/8	20
C295-0215-PH	1-3/8	10
C295-0295-PH	1-5/8	5
C295-0390-PH	2-1/8	1
C295-0520-PH	2-5/8	1
C295-0650-PH	3-1/8	1
C295-0750-PH	3-5/8	1
C295-0850-PH	4-1/8	1



END CAP

Part code	Size (inches)	Pack QTY
C154-0002-PH	3/8	100
C154-0025-PH	1/2	100
C154-0050-PH	5/8	50
C154-0090-PH	3/4	50
C154-0100-PH	7/8	25
C154-0150-PH	1-1/8	25
C154-0215-PH	1-3/8	10
C154-0295-PH	1-5/8	10
C154-0390-PH	2-1/8	5
C154-0520-PH	2-5/8	1
C154-0650-PH	3-1/8	1
C154-0750-PH	3-5/8	1
C154-0850-PH	4-1/8	1



STRAIGHT COUPLER (CXC)

Part code	Size (inches)	Pack QTY
C165-0001-PH	1/4 x 1/4	100
C165-0002-PH	3/8 x 3/8	100
C165-0025-PH	1/2 x 1/2	100
C165-0050-PH	5/8 x 5/8	100
C165-0090-PH	3/4 x 3/4	100
C165-0100-PH	7/8 x 7/8	50
C165-0150-PH	1-1/8 x 1-1/8	25
C165-0215-PH	1-3/8 x 1-3/8	25
C165-0295-PH	1-5/8 x 1-5/8	10
C165-0390-PH	2-1/8 x 2-1/8	5
C165-0520-PH	2-5/8 x 2-5/8	1
C165-0650-PH	3-1/8 x 3-1/8	1
C165-0750-PH	3-5/8 x 3-5/8	1
C165-0850-PH	4-1/8 x 4-1/8	1

COPPER FITTINGS

REDUCER COUPLER (CXC)



Part code	Size (inches)		Pack QTY
	1	2	
C165-0007-PH	3/8	1/4	100
C165-0032-PH	1/2	3/8	100
C165-0033-PH	1/2	1/4	100
C165-0058-PH	5/8	1/2	100
C165-0059-PH	5/8	3/8	100
C165-0093-PH	3/4	5/8	50
C165-0094-PH	3/4	1/2	100
C165-0107-PH	7/8	5/8	50
C165-0108-PH	7/8	1/2	50
C165-0149-PH	7/8	3/4	50
C165-0159-PH	1-1/8	7/8	25
C165-0160-PH	1-1/8	5/8	25
C165-0161-PH	1-1/8	1/2	25
C165-1498-PH	1-1/8	3/4	25
C165-0222-PH	1-3/8	1-1/8	25
C165-0223-PH	1-3/8	7/8	25
C165-0224-PH	1-3/8	5/8	10
C165-0030-PH	1-5/8	1-3/8	10
C165-0304-PH	1-5/8	1-1/8	10
C165-0305-PH	1-5/8	7/8	10
C165-0398-PH	2-1/8	1-5/8	10
C165-0399-PH	2-1/8	1-3/8	10
C165-0400-PH	2-1/8	1-1/8	10
C165-0401-PH	2-1/8	7/8	10
C165-0531-PH	2-5/8	2-1/8	1
C165-0532-PH	2-5/8	1-5/8	1
C165-0533-PH	2-5/8	1-3/8	1
C165-0662-PH	3-1/8	2-5/8	1
C165-0663-PH	3-1/8	2-1/8	1
C165-0664-PH	3-1/8	1-5/8	1
C165-0790-PH	3-5/8	3-1/8	1
C165-0852-PH	4-1/8	2-5/8	1

REDUCER COUPLER (FXC)



Part code	Size (inches)		Pack QTY
	1	2	
C410-0007-PH	3/8	1/4	100
C410-0032-PH	1/2	3/8	100
C410-0033-PH	1/2	1/4	100
C410-0058-PH	5/8	1/2	100
C410-0059-PH	5/8	3/8	100
C410-0093-PH	3/4	5/8	50
C410-0094-PH	3/4	1/2	50
C410-0095-PH	3/4	3/8	50
C410-0107-PH	7/8	5/8	50
C410-0108-PH	7/8	1/2	50
C410-0109-PH	7/8	3/8	50
C410-0149-PH	7/8	3/4	50
C410-0159-PH	1-1/8	7/8	25
C410-1498-PH	1-1/8	3/4	25
C410-0160-PH	1-1/8	5/8	25
C410-0161-PH	1-1/8	1/2	25
C410-0222-PH	1-3/8	1-1/8	25
C410-0223-PH	1-3/8	7/8	25
C410-0224-PH	1-3/8	5/8	25
C410-0303-PH	1-5/8	1-3/8	10
C410-0304-PH	1-5/8	1-1/8	10
C410-0305-PH	1-5/8	7/8	10
C410-0306-PH	1-5/8	5/8	10
C410-0398-PH	2-1/8	1-5/8	10
C410-0399-PH	2-1/8	1-3/8	10
C410-0400-PH	2-1/8	1-1/8	10
C410-0401-PH	2-1/8	7/8	10
C410-0402-PH	2-1/8	5/8	10
C410-0531-PH	2-5/8	2-1/8	1
C410-0532-PH	2-5/8	1-5/8	1
C410-0533-PH	2-5/8	1-3/8	1
C410-0662-PH	3-1/8	2-5/8	1
C410-0663-PH	3-1/8	2-1/8	1
C410-0664-PH	3-1/8	1-5/8	1
C410-0754-PH	3-5/8	3-1/8	1
C410-0850-PH	4-1/8	2-1/8	1
C410-0852-PH	4-1/8	2-5/8	1
C410-0854-PH	4-1/8	3-1/8	1



COPPER FITTINGS



MALE ADAPTOR (C X MALE NPT)



Part code	Size (inches)	Pack QTY
	1 2	
C101-0005-PH	3/8 x 1/2	50
C101-0007-PH	3/8 x 1/8	50
C101-0025-PH	1/2 x 3/8	50
C101-0050-PH	5/8 x 1/2	50
C101-0057-PH	5/8 x 3/4	50
C101-0058-PH	5/8 x 3/8	50
C101-0100-PH	7/8 x 3/4	10
C101-0150-PH	1-1/8 x 1	5
C101-0159-PH	1-1/8 x 3/4	5
C101-0215-PH	1-3/8 x 1-1/4	5
C101-0295-PH	1-5/8 x 1-1/2	2
C101-0390-PH	2-1/8 x 2	1

FEMALE ADAPTOR (C X FEMALE NPT)



Part code	Size (inches)	Pack QTY
	1 2	
C105-0025-PH	3/8 x 1/2	50
C105-0050-PH	5/8 x 1/2	50
C105-0057-PH	5/8 x 3/4	25
C105-0058-PH	3/8 x 5/8	50
C105-0059-PH	1/4 x 5/8	50
C105-0100-PH	7/8 x 3/4	10
C105-0107-PH	7/8 x 1/2	10
C105-0150-PH	1-1/8 x 1	5
C105-0159-PH	1-1/8 x 3/4	5
C105-0215-PH	1-3/8 x 1-1/4	5
C105-0295-PH	1-5/8 x 1-1/2	2
C105-0390-PH	2-1/8 x 2	1

U-TYPE STRAP



Part code	Size (inches)	Pack QTY
C947-0025-PH	1/2	100
C947-0050-PH	5/8	50
C947-0090-PH	3/4	50
C947-0100-PH	7/8	50
C947-0150-PH	1-1/8	10
C947-0215-PH	1-3/8	10
C947-0295-PH	1-5/8	10
C947-0390-PH	2-1/8	5

180° RETURN BEND



Part code	Size (inches)	Pack QTY
C180-0002-PH	3/8	100
C180-0025-PH	1/2	100
C180-0050-PH	5/8	50
C180-0090-PH	3/4	50
C180-0100-PH	7/8	50
C180-0150-PH	1-1/8	50
C180-0215-PH	1-3/8	25
C180-0295-PH	1-5/8	25
C180-0390-PH	2-1/8	25
C101-0215-PH	1-3/8	5
C101-0295-PH	1-5/8	2
C101-0390-PH	2-1/8	1

EQUAL TEE (CXCXC)



Part code	Size (inches)	Pack QTY
C460-0001-PH	1/4	100
C460-0002-PH	3/8	100
C460-0025-PH	1/2	100
C460-0050-PH	5/8	50
C460-0090-PH	3/4	50
C460-0100-PH	7/8	25
C460-0150-PH	1-1/8	10
C460-0215-PH	1-3/8	10
C460-0295-PH	1-5/8	5
C460-0390-PH	2-1/8	1
C460-0520-PH	2-5/8	1
C460-0650-PH	3-1/8	1
C460-0750-PH	3-5/8	1
C460-0850-PH	4-1/8	1

P TRAP



Part code	Size (inches)	Pack QTY
C533-0050-PH	5/8	5
C533-0090-PH	3/4	2
C533-0100-PH	7/8	2
C533-0150-PH	1-1/8	1
C533-0215-PH	1-3/8	1
C533-0295-PH	1-5/8	1
C533-0390-PH	2-1/8	1

COPPER FITTINGS



REDUCER TEE (CXC)



Part code	Size (inches)			Pack QTY
	1	2	3	
C460-0005-PH	3/8	3/8	1/4	100
C460-0006-PH	3/8	3/8	1/2	100
C460-0031-PH	1/2	1/2	5/8	100
C460-0032-PH	1/2	1/2	3/8	100
C460-0033-PH	1/2	1/2	1/4	100
C460-0040-PH	1/2	3/8	1/2	100
C460-0041-PH	1/2	3/8	3/8	100
C460-0056-PH	5/8	5/8	1-1/8	25
C460-0057-PH	5/8	5/8	7/8	25
C460-0058-PH	5/8	5/8	1/2	50
C460-0059-PH	5/8	5/8	3/8	50
C460-0066-PH	5/8	1/2	5/8	50
C460-0067-PH	5/8	1/2	1/2	50
C460-0068-PH	5/8	1/2	3/8	50
C460-0076-PH	5/8	3/8	1/2	50
C460-0087-PH	5/8	5/8	3/4	50
C460-0092-PH	3/4	3/4	7/8	50
C460-0093-PH	3/4	3/4	5/8	50
C460-0094-PH	3/4	3/4	1/2	50
C460-0095-PH	3/4	3/4	3/8	50
C460-0098-PH	3/4	5/8	5/8	50
C460-0106-PH	7/8	7/8	1-1/8	25
C460-0107-PH	7/8	7/8	5/8	25
C460-0108-PH	7/8	7/8	1/2	25
C460-0109-PH	7/8	7/8	3/8	25
C460-0111-PH	7/8	1/2	7/8	25
C460-0117-PH	7/8	5/8	7/8	25
C460-0118-PH	7/8	5/8	5/8	25
C460-0119-PH	7/8	5/8	1/2	25
C460-0127-PH	7/8	1/2	5/8	25
C460-0157-PH	1-1/8	1-1/8	1-5/8	10
C460-0158-PH	1-1/8	1-1/8	1-3/8	10
C460-0159-PH	1-1/8	1-1/8	7/8	10
C460-1498-PH	1-1/8	1-1/8	3/4	10
C460-0160-PH	1-1/8	1-1/8	5/8	10
C460-0161-PH	1-1/8	1-1/8	1/2	10
C460-0169-PH	1-1/8	7/8	1-1/8	10
C460-0170-PH	1-1/8	7/8	7/8	10
C460-0171-PH	1-1/8	7/8	5/8	10
C460-0180-PH	1-1/8	5/8	1-1/8	10
C460-0181-PH	1-1/8	5/8	7/8	10

Part code	Size (inches)			Pack QTY
	1	2	3	
C460-0220-PH	1-3/8	1-3/8	2-1/8	5
C460-0221-PH	1-3/8	1-3/8	1-5/8	10
C460-0222-PH	1-3/8	1-3/8	1-1/8	10
C460-0223-PH	1-3/8	1-3/8	7/8	10
C460-0224-PH	1-3/8	1-3/8	5/8	10
C460-0234-PH	1-3/8	1-1/8	1-3/8	10
C460-0235-PH	1-3/8	1-1/8	1-1/8	10
C460-0237-PH	1-3/8	1-1/8	5/8	10
C460-0245-PH	1-3/8	7/8	1-3/8	10
C460-0246-PH	1-3/8	7/8	1-1/8	10
C460-0247-PH	1-3/8	7/8	7/8	10
C460-0302-PH	1-5/8	1-5/8	2-1/8	5
C460-0303-PH	1-5/8	1-5/8	1-3/8	5
C460-0304-PH	1-5/8	1-5/8	1-1/8	5
C460-0305-PH	1-5/8	1-5/8	7/8	5
C460-0306-PH	1-5/8	1-5/8	5/8	5
C460-0315-PH	1-5/8	1-3/8	1-5/8	5
C460-0316-PH	1-5/8	1-3/8	1-3/8	5
C460-0328-PH	1-5/8	1-1/8	1-5/8	5
C460-0330-PH	1-5/8	1-1/8	1-1/8	5
C460-0331-PH	1-5/8	1-1/8	7/8	5
C460-0339-PH	1-5/8	7/8	1-5/8	5
C460-0397-PH	2-1/8	2-1/8	2-5/8	1
C460-0398-PH	2-1/8	2-1/8	1-5/8	1
C460-0399-PH	2-1/8	2-1/8	1-3/8	1
C460-0400-PH	2-1/8	2-1/8	1-1/8	1
C460-0401-PH	2-1/8	2-1/8	7/8	1
C460-0414-PH	2-1/8	1-5/8	1-5/8	1
C460-0416-PH	2-1/8	1-5/8	1-1/8	1
C460-0417-PH	2-1/8	1-5/8	7/8	1
C460-0429-PH	2-1/8	1-3/8	2-1/8	1
C460-0431-PH	2-1/8	1-3/8	1-3/8	1
C460-0432-PH	2-1/8	1-3/8	1-1/8	1
C460-0531-PH	2-5/8	2-5/8	2-1/8	1
C460-0532-PH	2-5/8	2-5/8	1-5/8	1
C460-0533-PH	2-5/8	2-5/8	1-3/8	1
C460-0534-PH	2-5/8	2-5/8	1-1/8	1
C460-0535-PH	2-5/8	2-5/8	7/8	1
C460-0549-PH	2-5/8	2-1/8	2-1/8	1
C460-0663-PH	3-1/8	3-1/8	2-1/8	1
C460-0664-PH	3-1/8	3-1/8	1-5/8	1



FLEXI SUPPORT SYSTEMS



EVERYDAY

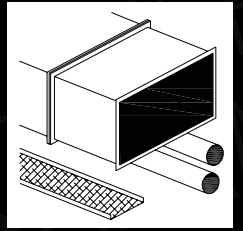

ACCESS

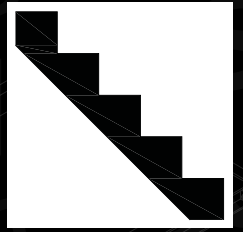

HEAVY

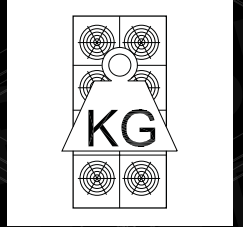

LIGHT

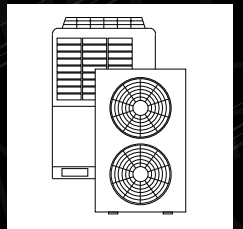

SOLAR

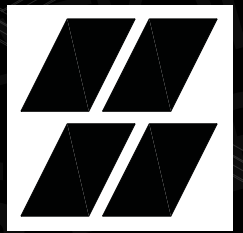

FLEXI RANGE
PAGE 109

sales@flexisupportsystems.com
www.flexisupportsystems.co.uk

SERVICE AND MAINTENANCE



PRO RANGE CONCENTRATED CLEANERS - 5L

Already established as a leading brand of professional coil cleaning and maintenance products, the DiversiTech PRO-RANGE of concentrated coil cleaners are designed to provide outstanding cleaning results combined with minimal environmental impact and maximum economy. Pro Universal is registered as NSF Food Safe, making it ideal to use in and around food processing areas.



Part code	Description	Size	Suitable for use on
PRO-UNIV-GB	"Concentrated - Indoor & Outdoor NSF Registered Food Safe Coil Cleaner"	5 Litre	Condensers / Evaporators / Air Filters
PRO-FOAM+GB	"Concentrated - Heavy Duty Alkaline Based Condensing Coil Cleaner"	5 Litre	Condensers
PRO-CARE-GB	"Concentrated - Evaporator Coil Cleaner with Disinfectant"	5 Litre	Evaporators / Protecting & Disinfectants
PRO-CLEAN-GB	Concentrated - Alkaline Based Evaporator & Condensing Coil Cleaner	5 Litre	Condensers / Evaporators
PRO-COOL-GB	"Concentrated - Non-Odour Liquid Ice Machine Cleaner"	5 Litre	Ice Machines
PRO-SCALE-GB	Concentrated - Lime Scale Remover	5 Litre	Condensers / Exchangers
PRO-GREEN-GB	Concentrated - Environmentally Friendly Indoor and Outdoor Coil Cleaner	5 Litre	Condensers / Evaporators / Air Filers

G2G RANGE PRE-MIXED CLEANERS - 1L

The DiversiTech G2G-RANGE (Good to Go) are pre-mixed coil cleaners in a 1 litre convenient trigger bottle for quick and easy application.

G2G Universal is registered as NSF Food Safe, making it ideal to use in and around food processing areas.



Part code	Description	Size	Suitable for use on
G2G-UNIV-GB	Pro Universal Pre-Mixed Coil Cleaner	1 Litre	Condensers / Evaporators / Air Filters
G2G-FOAM+GB	Foaming Alkaline Based Pre -Mixed Coil Cleaner	1 Litre	Condensers
G2G-CARE-GB	Liquid Coil Cleaner with Disinfectant	1 Litre	Evaporators / Protecting & Disinfectant
G2G-GREEN+GB	Environmentally Friendly Pre -Mixed Coil Cleaner	1 Litre	Condensers / Evaporators / Air Filter
G2G-BUBBLE+-GB	Bubble Up Leak Detector Pre-Mixed	1 Litre	Leak Detector

AEROSOLS

These professional aerosols are the perfect blend of high performance and excellent economy. The range has seen improvements in formulation and scent.



Part code	Description	Size	Suitable for use on
AER-D-600	Coil Clean - Universal Coil Cleaner	600ml	Condensers / Evaporators
AER-F-600	Coil Foam - Heavy Duty Condenser Cleaner	600ml	AC & Refrigeration Condenser Coils
AER-I-600	Coil Care - Evaporator Cleaner & Disinfectant	600ml	Evaporators
AER-C-600	Case Clean - Case, Fascia & Glass Cleaner	600ml	Fan Coils, Cassette Units & Boiler Cases
AER-B-500	Leak Seek - Bubble Up Detector Spray	500ml	Leak Detector

ODOUR ELIMINATION

The Smell Buster range is a unique odour elimination product that effectively neutralises bad smells in air conditioning systems. Available in 1 Litre pre-mixed spray bottles, 60g twin pack, 12g ten pack and 225g tray.



Part code	Description	Size	Suitable for use on
G2G-SMELL-BUSTER	Smell Buster Pre Mixed	1 Litre	RAC Systems

COMPRESSION SPRAYERS

Various hand held and compression sprayers are available for applying coil cleaners to the coils. Designed for a fast and easy application.



Part code	Description	Capacity
1002	Hand Held Sprayer	1.4 Litres
2603	Compression Sprayer - 3 Gallon	11.4 Litres

CoilJet® from SpeedClean®



SEE PAGE 189

SERVICE AND MAINTENANCE



DIVERSI-FLUSH

Dirty and contaminated system? We have a unique system and line cleaning solution, ideal for dealing with compressor burn outs, R22 retrofits and equipment upgrades and replacements.

Effectively removes all traces of residual oil and contaminants, this easy-to-use kit includes everything needed to quickly and effectively clean the entire system.



Part code	Description	Size	Suitable for use on
PF-KIT-EU	Diversi-Flush HVAC Flushing Kit - includes refill	480ml	Compressor Burnouts, R22 retrofits, upgrades
PF-16-EU	Diversi-Flush Solve nt Refill	480ml	Compressor Burnouts, R22 retrofits, upgrades
PF-ADAPTOR	Line Set Adaptor		Compressor Burnouts, R22 retrofits, upgrades

DRAINGUN

Blocked drain line - no problem with our DrainGun™. This lightweight, portable tool is designed to unblock condensate drain lines and other pipework instantly.

Simply insert a CO² cartridge in to the DrainGun and with a press of the trigger, SWOOSH, 800 psi of food grade CO² blows the blockage out.



Part code	Description	Size
GG-1	Drain Gun Line Cleaner	Single Pack
GGC-12	Drain Gun - Pack of 12, CO ² Cartridges	Pack of 12
GG-1A	Drain Gun - Adaptor Kit - for larger tubes, oil lines and 90 degree angles	3 adaptors
GG-1H	Drain Gun - Hose Assembly	Single Pack

VORTEX MAP-X BRAZING GAS

Map-X burns hotter than Vortex Propane, which makes it ideal for high-temperature applications. Sold in 400g non-refillable canister. Vortex gases are designed for use with any of our Vortex range of brazing torches.



Part code	Description	Size
VG1	Vortex Map-X gas cannister	400g

NITROGEN PURGE & BRAZING TOOL

The DP-1 Nitrogen Purge Tool is a quick and easy way to purge copper pipes with nitrogen. Connect and turn the dial, this switches to a very low flow of nitrogen to braze the copper. It has a durable aluminium design so you can just throw it into your tool bag when you are done. Can save nitrogen gas used when brazing and purging.



Part code	Description	QTY	Suitable for use on
DP-1	Nitrogen Purge Tool	1	Purging and controlling the flow of nitrogen through pipework during brazing

UNIVERSAL COPPER SPUN DRIERS

Manufactured with the latest generation molecular sieves and compatible with many refrigerants including R134a, our universal copper spun driers can be used in all hermetic and open compressor refrigeration systems. This includes commercial and domestic refrigerators, freezers and air conditioners up to 2.0 HP. The driers are hermetically sealed with extended ends.



Part code	Outlet	Inlet	Diameter	Length	Desiccant R12	Tonnage	QTY
DX-3	1/4" (6mm)	1/4" (6mm)	3/4" (19mm)	7-11/16" (195mm)	10	1/2 (1.75kW)	1
DX-4	Multiple	1/4" (6mm)	1" (6mm)	9" (228mm)	18	1-1/2 (5kW)	1
DXA-5	1/4" (6mm)	1/4" (6mm)	1" (6mm)	9-1/4" (235mm)	20	1-1/2 (5kW)	1

TELESCOPIC INSPECTION MIRRORS

Fast, accurate visual inspection of hidden areas with an almost limitless number of positions. Double ball joint links swivel mirrors for viewing 360 degrees. Precision engineered links are made from tempered spring steel to withstand the stresses of constant repositioning. Moves freely and holds in the desired position.



Part code	Description	QTY
M-1	Mirror 1-1/4" circular - extends 6-1/4" to 18-1/4"	1
M-2	Mirror 2-1/4" circular - extends 10" to 14"	1
M-2R	Replacement Head for M-2	1
M-3	Mirror 2-1/8" x 3-1/2" rectangular - extends 11-1/4" to 15-1/4"	1
M-4	Mirror 7/8" Circular - extends 6-1/2"	1
M-5	Mirror 1" x 2" Oval - extends 8-1/2"	1

TOOLS



FIN-TOOLS & SUPERCOMB

The Multihead fin-tool conveniently straightens and cleans condenser and evaporator fins. Each nylon head slides into the master handle and tightens in place. Heads are coloured and engraved with the size for fast identification. The metal fin straighteners have heavy duty spring wire bristles. The SuperComb has 6 coloured fins. The fin brush is a plastic handled fin brush to clean condenser and evaporator fins



Part code	Description	Pack QTY
T-100	Hilmor Kit 1 – Handle with 6 Heads – 8,9,10,11,12,14, FPI	1
T-101	Kit 2 – Handle with 6 Heads – 13,15,16,17,18,20	1
T-8	Head 8 FPI – Orange	Pack of 3
T-9	Head 9 FPI – Yellow	Pack of 3
T-10	Head 10 FPI – Neutral	Pack of 3
T-11	Head 11 FPI – Blue	Pack of 3
T-12	Head 12 FPI – Green	Pack of 3
T-13	Head 13 FPI – Pink	Pack of 3
T-15	Head 15 FPI – Aqua	Pack of 3
T-16	Head 16 FPI – Brown	Pack of 3
T-20	Head 20 FPI – Purple	Pack of 3
T-21	Head 21& 22 FPI – Rose	Pack of 3

Part code	Description	Pack QTY
T-200	Fin Tool	1
T-300	Fin Tool with Heavy Duty Bicycle Handle	1



Part code	Description	Pack QTY
T-400	Set of 6 T-408, T409, T-410, T411, T417, T418	1
T-411	11 and 13 FPI – Blue	1
T-417	16 and 17 FPI – Lime	1
T-418	18 and 20 PI – Red	1



Part code	Description	Pack QTY
B-26	Fin Brush	12

COMPRESSOR TOTE

Makes light work of a heavy job. Made from a strong powder coated steel. Recommended for use with all compressors up to 5 tons.



Part code	Description	Pack QTY
ACT-6	Compressor tote	30

CLIPLIGHT - PIVOT™ TORCHES

The Pivot™ range has a 360 degree swivel hook and is magnetic at the base and back. Available in colours Yellow/Black and Camo. All models are supplied with three AA batteries.

Part code	Description
24-458	Pivot 33 - 28 LED Front Light / 5 LED Top
24-460	Pivot 33 - 28 LED Front Light / 5 LED Top

Part code	Colour	Lumens
24-458	Yellow/Black	160
24-460	Camo	160

Part code	UOM	Master QTY
24-458	Each	Pack of 9
24-460	Each	Pack of 9



CLIPLIGHT - CLIPSTRIP™ TORCHES

The Clipstrip™ range is a powerful pocket light with clip, available in colours Yellow/Black and Camo. A waterproof aqua clipstrip is available. All models are supplied with three AAA batteries.



Part code	Description	Colour	Lumens	UOM	Master QTY
111112	Clipstrip - Pocket Light	Yellow / Black	140	Each	Pack of 12
111116	Clipstrip - Pocket Light	Camo	140	Each	Pack of 12

TORCHES AND LIGHTS



CLIPLIGHT SEEKER™ TORCHES

The Seeker™ range has a mini and max version. The UV light provides a circular spotlight with wide, focused or strobing capacities.

The mini can fit easily in your pocket and runs from AAA batteries. The max runs from a rechargeable lithium battery.



Part code	Description	Colour	Lumens	UOM	Master QTY
84DCPLUS	Seeker - Mini UV LED Circular Spotlight	Red	UV Light	Each	Individual
87DCPLUS	Seeker - Max UV LED Rechargeable Circular Spotlight	Red	UV Light	Each	Individual

CLIPLIGHT FOCUS & STROBE

The Focus & Strobe light packs a big punch for a small light. The powerful single white LED delivers a constant or stobe beam, which can be focused for intensity.



Part code	Description	Colour	Lumens	UOM	Master QTY
111201	Focus & Strobe	Blue	180	Each	Individual

PAC-IHP-12-BLK

PORTABLE AC (HEAT & COOL)

**SLEEK
BLACK
FINISH**

PORTABLES FAMILY

SEE PAGE 85

SUPER SEAL PREMIUM & PLATINUM™ - PRO A/C STOP LEAK

Super Seal Premium and Platinum seals leaks in evaporators, condensers, accumulators as well as o-rings, gaskets, metal lines and rubber hoses. Actively prevents future leaks.

Easily installed in minutes and is compatible with all mobile A/C refrigerants including R12, R134A, and R1234YF. Hose included.



Part code	Description	Capacity	UOM	Master Qty
946KIT	Super Seal Premium - with Pro A/C Stop Leak	1.5oz / 45ml	Each	12
976KIT	Super Seal Platinum - with Dry R & FLASH UV Dye	1.7oz / 51ml	Each	12

LUBRICANTS AND DYES

OILS & CLEANERS



PAO 68 OIL



PAO 68 OIL & UV DYE

AC DYE



900008

RADIATOR DYE



990006B

Part code	Brand	Description	Size	Type
51105	Cliplight	PAO 68 Oil	500ml (17oz)	Lubricant
51111	Cliplight	PAO 68 Oil & Dye	1 Litre (34oz)	Lubricant & Dye
900008	Cliplight	A/C Dye	236ml (8oz)	A/C Dye
990006B	Cliplight	Radiator Dye	30ml (1oz)	Radiator Dye

REDBOX MINI RANGE OF PUMPS

TRUNK

UNIVERSAL

SLIM

TUBE

COMPACT

21 DB(A)

SEE PAGE 18

SEALANT

LEAK ARMOR SEALANT KITS



Leak Armor is a 2-in-1 system additive that will find and seal leaks in refrigeration systems. It also contains an eliminator to dry any moisture in the system, preventing waxing and acid formation.

Leak Armor is a light, low viscosity particle free liquid that is directly placed into the system as a mist - as it travels with the refrigerant and oil throughout the system, the sealant exits the leak point and reacts with moisture in the air - this forms a low tensile crystalline structure that creates a permanent seal. Leak Armor comes with a reusable hose.

Part code	Description	Capacity	UOM	Master Qty
944KIT-LEAKARMOR	Leak Armor for systems up to 12 tons (42Kw)	2oz / 59ml	Each	12
972KIT-LEAKARMOR	Leak Armor UV for systems up to 12 tons (42Kw)	2oz / 59ml	Each	12
947KIT	Super Seal Advanced - up to 1.5 tons (5kW)	1oz / 30ml	Each	12

BLACK GUARDS

SEE PAGE 103

INSTALL

RAPID-O PUSH FIT FITTINGS

The fastest and easiest way to connect copper refrigeration pipes. Rapid-O offers a full range of high-quality fittings, the fastest and easiest way to connect copper refrigeration pipes.

- Fast and easy to use
- Reusable and durable
- With unique fittings that get the job done 90% faster
- Better than the traditional way of connecting copper pipes

CONNECTION PIECE



UNIT SOCKET



90° ELBOW



RELEASE TOOL



MARKING TOOL



Part code	C code	Description
ACR-DM1	0512.00005.001	Rapid-O Marking Tool - 1/4 to 3/8
ACR-DM2	0512.00005.002	Rapid-O Marking Tool - 1/2 to 5/8
ACR-RT0250	0512.00004.001	Rapid-O 1/4" HVAC Release Tool
ACR-RT0375	0512.00004.002	Rapid-O 3/8" HVAC Release Tool
ACR-RT0500	0512.00004.003	Rapid-O 1/2" HVAC Release Tool
ACR-RT0625	0512.00004.004	Rapid-O 5/8" HVAC Release Tool
ACRSC-0250	0512.00001.001	Rapid-O 1/4" Connection Piece - Pack of 5 Sold Individually
ACRSC-0375	0512.00001.002	Rapid-O 3/8" Connection Piece - Pack of 5 Sold Individually
ACRSC-0500	0512.00001.003	Rapid-O 1/2" Connection Piece - Pack of 5 Sold Individually
ACRSC-0625	0512.00001.004	Rapid-O 5/8" Connection Piece - Pack of 5 Sold Individually
ACRSE-0250	0512.00002.001	Rapid-O 1/4" 90° Elbow - Pack of 5 Sold Individually
ACRSE-0375	0512.00002.002	Rapid-O 3/8" 90° Elbow - Pack of 5 Sold Individually
ACRSE-0500	0512.00002.003	Rapid-O 1/2" 90° Elbow - Pack of 5 Sold Individually
ACRSE-0625	0512.00002.004	Rapid-O 5/8" 90° Elbow - Pack of 5 Sold Individually
ACRSS-0250	0512.00003.001	Rapid-O 1/4" Socket - Pack 5 Sold Individually
ACRSS-0375	0512.00003.002	Rapid-O 1/2" Socket - Pack 5 Sold Individually
ACRSS-0500	0512.00003.003	Rapid-O 3/8" Socket - Pack 5 Sold Individually
ACRSS-0625	0512.00003.004	Rapid-O 5/8" Socket - Pack 5 Sold Individually



RAPID-O 90° ELBOW



RAPID-O UNIT SOCKET



RAPID-O CONNECTION PIECE



RAPID-O RELEASE TOOL

ACCESSORIES



PRO BUBBLE LEAK DETECTOR SPRAY

Pro Bubble is an easy to use leak detector spray, ideal for locating gas and air leaks in pipes and equipment. It will not attack or react with metal surfaces and is highly efficient for the detection of ammonia, refrigerant gas and air leaks at below freezing temperatures.



Part code	Description	UOM	Master Qty
PRO-BUBBLE-32	Pro-Bubble Leak Detector Spray - 32oz with spray top	Each	12

COOL-WELD™ HEAT BARRIER SPRAY

Cool-Weld™ is a spray on gel heat shield for soldering, sweating and welding. Ideal for use on filter driers, pipes, valves, sheet metals, etc. Can be used on porous surfaces such as fabrics or drywall. As long as there is some Cool-Weld™ present the surface will resist charring.



Part code	Description	UOM	Master Qty
COOLWELD-32	Cool-Weld Heat Barrier Spray - 32oz with spray top	Each	12

3-IN-ONE MULTI-PURPOSE OIL

This 3-in-one oil lubricates, cleans and prevents rust.



Part code	Description	Master Qty
3in1	3 in 1 multipurpose oil	100ml

WYPALL CLOTHS

Heavy duty towels that absorb grease, oil, water and solvents from floors, hands, parts, tools and machinery.



Part code	Description	UOM	Master Qty
5-05790	WypAll Plus Towels - White	Each	Box of 9

EXPANDING FOAM SEALANT

A one component closed-cell expanding polyurethane foam sealant that is tack free in 20 minutes. Can be painted to prevent UV damage after 12 hours of drying time. Used to seal around doors, windows, pipes, ducts and vents - in fact, virtually anywhere.



Part code	Description	UOM	Master Qty
FOAM-152760	Gap filler expanding foam - 300ml	Each	12
FOAM-135234	Gap filler expanding foam - 600ml	Each	12

SILICONE SEALANTS

Available in clear or white, DiversiTech silicone sealants are 100% food grade and can be used in applications for continuous use up to 232°C. It is UV and water resistant and has long term flexibility.



Part code	Description	UOM	Master Qty
7-4000	Clear Silicone Sealant - 305ml	Each	12
7-4100	White Silicone Sealant - 305ml	Each	12

DIVERSI-GUM SEALING COMPOUND

Diversi-Gum is a non-hardening, non-corrosive sealing compound that is immediately paintable and has a temperature usage range between -4°C and 49°C. It is ideal for sealing openings through foundations or refrigeration pipe entries.



Part code	Description	UOM	Master Qty
6-202-1	Diversi-Gum Sealing compound 450g slug	Each	24
6-202-2	Diversi-Gum Sealing compound 900g slug	Each	20

PRO-TITE™ RESIN BASED THREAD SEALANT

A resin-based thread sealant that adheres to internal surfaces and fills voids while forming a fluid tight seal. Sealing from full vacuum up to 10,000 psi, Pro-Tite is specially formulated for use on metals and plastics subject to extreme vibration. Having a temperature range between -73°C to 204°C, Pro-Tite is impervious to most chemicals, including refrigerants, petroleum products, gases, steam etc.



Part code	Description	UOM	Master Qty
CLL-1-EU	Pro Tite Squeeze Tube - 39ml	Each	12

ACCESSORIES



ACID TEST KITS

Detects acid in refrigeration oil. Convenient one step test means no chemicals are needed. Easy to evaluate, the colour change indicates acidity, the intensity of the colour indicates the amount of acid that is present in the oil sample.



Part code	Description	UOM	Master Qty
ATK-1-EU	Acid Test Kit - Pack of 4 for AB and Mineral oil	Each	1
ATK-1P-EU	Acid Test Kit - with POE Oil	Each	1

ACID ELIMINATOR

Keeps acid away; compatible with all refrigerants and oils. Chemically neutralises and prevents acids that are formed in air conditioning and refrigeration systems due to refrigerant and refrigeration oil break-down, moisture, and compressor burnout. Easy-to-use, no complicated charts. Works fast, circulates quickly, and leaves no solids or solid residual. Will not harm system components. Can prevent system breakdown.



Part code	Description	UOM	Master Qty
ACID-ELIM	Acid Eliminator - 115ml	Each	12

FLOW-PLUS CONDENSATE PAN TREATMENT

A range of Drain Pan treatments to help prevent blockages resulting in condensate overflow. Simply place the tablets in the drain pan, where they will slowly dissolve in the condensate to give a prolonged cleaning action on the sludge. One or two tablets are recommended in each pan per month.

FLOW-PLUS-25



Part code	Description	Equipment tonnage	UOM	Master Qty
FLOW-PLUS-25	Flow Plus Condensate Drain Pan Tablets - 25 Tablets per Jar	1/2 to 3 tons	Each	12

FLEXI PATCH™

Flexi-Patch™ is an easy to use flexible repair patch ideal for repairing almost any surface. It cures quickly using only UV light from sunlight or a UV flashlight for a long lasting, permanent repair.

Flexi-Patch is a fibreglass-reinforced polyester ideal for use on PVC, plastics, metal, wood, concrete and more. It's the easy way to permanently patch almost any surface. It dries hard for permanent repair. Can be drilled and painted once dry.



Part code	Description	UOM	Master Qty
FP-36	Flexi Patch Fibreglass repair patch - 75mm x 150mm - 10 per pack	Each	20

LINE PIERCING VALVES AND TOOLS



QUICK TAP

Features a valve core in the 1/4in. male port. Simply pierce the line and back seat the needle. Flow starts when depressor type charging hose is connected.

Part code	Description	UOM	Master Qty
QT-1	Quick Tap - 1/4", 5/16", 3/8" OD (6.4mm, 8mm, 9mm)	Each	1
QT-2	Quick Tap - 1/2", 5/8" OD (13mm, 16mm)	Each	1



QUICK TAP-2

Identical to the quick tap except that a nylon handle replaces the hex wrench, Phillips-head screws are used

Part code	Description	UOM	Master Qty
QTH-1	Quick Tap 2 - 1/4", 5/16", 3/8" OD (6.4mm, 8mm, 9mm)	Each	1
QTH-2	Quick Tap 2 - 1/2", 5/8" OD (13mm, 16mm)	Each	1



MAC - THE ULTIMATE IN LINE PIERCING VALVES

Install valve, connect charging hose, then service. That's all there is to it with a MAC line piercing valve. MAC valves feature a uniport single connection for piercing and servicing. Sealed with refrigerant resistant 'O' rings, the needle automatically back seats after servicing to leave the line free of restriction.

Part code	Description	UOM	Master Qty
QTM-1	Line Piercing Valve - 1/4", 5/16", 3/8" OD (6.4mm, 8mm, 9mm)	Each	1
QTM-2	Line Piercing Valve - 1/2", 5/8" OD (13mm, 16mm)	Each	1



REFRIGERANT RECOVERY TOOL

Smart features that save refrigerant and time. Our Refrigerant Recovery Pliers make evacuating equipment quick and easy. The pliers have a valve on one end with a sharp needle point and a gasket to keep all recovered refrigerant in the system and prevent leaks.



Part code	Description	Sizes	Weight
1937677	Refrigerant recovery tool	1/4" to 1-1/8"	13 oz

ACCESSORIES



LINE TAP AND SWIVEL VALVES

The quick, safe and easy option to charge, discharge and test a line. Simply clamp on the DLT valve, attach the DLV-1G control valve and pierce the line. The valve can swivel to any position and can also be removed and re-used. Available in three sizes from 4.8mm OD tube to 9.5mm



Part code	Description	UOM	Master Qty
DLT-3G	Line Tap Valve - 4.75mm OD Tube	1	1
DLT-4G	Line Tap Valve - 6.35mm OD Tube	1	1
DLT-5G	Line Tap Valve - 8mm OD Tube	1	1
DCV-1G	Valve for DLT Line Taps	1	1

CORE STORER

All steel valve core remover and storage container. Completely knurled for easier grip, eliminating slippage when using with oily or greasy hands. Core Storer features a compartment for storing extra valve cores. Four replacement cores are included with each tool.



Part code	Description	UOM	Master Qty
VCR-1	Core Removal and Storer	1	1

CORE REMOVAL TOOL

Designed to remove and replace valve cores without losing the refrigerant charge. Connects to any 1/4in. male flare fitting. Saves time, saves refrigerant.



Part code	Description	UOM	Master Qty
VCRT-1	Core Removal Tool	1	1
VCRT-1R	Replacement Rod Assembly	1	1
VCRT-1S	Replacement Shut -Off Stem	1	1

RC-1 INSTA-CHARGE

Faster, safer and a more economical method for charging LIQUID refrigerant through the low pressure side of an air conditioning or refrigeration system, without damaging the compressor. Insta-Charge's unique internal restrictor reduces liquid flow to a level below the capacity of the compressor.

Converts liquid refrigerant to a saturated vapour for fast entry. Insta-Charge connects directly to the refrigerant can or cylinder valve. Adds liquid tracing dye faster. Eliminates heating of refrigerant cylinder. Made of light weight aluminium. Sold at a fraction of the cost of other fast charging devices.



Part code	Description	UOM	Master Qty
RC-1	Insta-Charge	1	1

TAPE

CORK & FOAM INSULATION TAPE



Cork insulation tape adheres firmly to all metals, the foam Insulation tape is a superior self-adhesive foam tape both of which can be used on hot or cold pipes to prevent heat loss and condensation dips. Easily cut and moulded, it fits well around valves and fittings.

ALUMINIUM FOIL TAPE



An easy to handle aluminium tape that prevents heating and cooling losses and blocks odours and moisture. Has a 3-5 year shelf life and a working temperature range of -37°C to 127°C (-35°F to 260°F)

Part code	Description	UOM	Master Qty
6-330	Cork Insulation Tape - Black 1/8" x 2" x 30ft Roll	1	1
6-9718	Foam Insulation Tape - Black 1/8" x 2" x 30ft Roll	1	1
640-AF-2	Aluminium Foil Tape - 2" x 50 yards Roll	1	1

ABRASIVE CLOTH



A high quality aluminium oxide 120 grit abrasive cloth, that can be used wet or dry to thoroughly clean steel and copper tubing.

Part code	Description	UOM	Master Qty
SC-10	Abrasive Cloth - 120 Grit - 1-1/2" x 10 yards	1	1

GRIP-CUT CLOTH



A 180 grit open mesh sand screen cloth with aluminium oxide bonding, that is 100% waterproof. Can be used by hand or with portable tools and is most effective where clogging would be a problem such as soft materials.

Part code	Description	UOM	Master Qty
SCM-5	Grip- Cut Open Mesh Sand Screen Cloth - 1-1/2" x 5 yards	1	1

BRAZE BARRIER MATS

This flame barrier drop cloth withstands temperatures to (1600°C) 3000°F No asbestos. Protects walls, floors, equipment, components and adjacent surfaces from torch flames when soldering, brazing or welding.

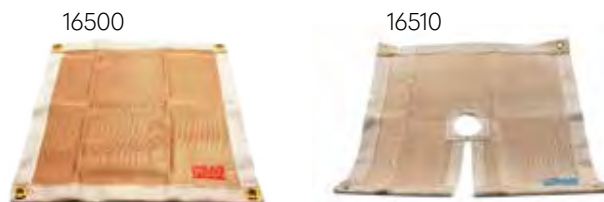

Part code	Description	UOM	Master Qty
16500	Plain Braze Barrier Mat 18" x 18"	1	1
16510	Keyhole Braze Barrier Mat - 18" x 18"	1	1

AIR SOURCE HEAT PUMP INSTALLATION SOLUTIONS

INSTALLING - CONNECTING - INSULATING - PROTECTING - MAINTAINING

sales@diversitech.com
www.diversitech.global

ASHP INSTALLATION
HOW-TO VIDEOS



FLEXI LITE SLAB KIT



ADJUSTABLE FEET



BRACKETS & TRAYS



INSULATION



SOAK-AWAY KIT



TRUNKING



THROUGH THE WALL

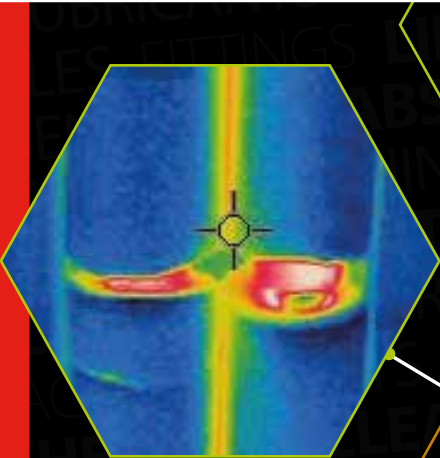

• INSULATION

• FLEXIBLE
CONNECTION
HOSES

• THROUGH THE
WALL INSULATION



• ISOLATORS



• GUARDS



• ISOLATORS



• ASHP
SOAKAWAY

ARE YOU GETTING
100% OF HEAT FROM
YOUR ASHP INSTALL
INTO THE PROPERTY?

DIVERSITECH[®]
INTERNATIONAL

• OVER 17 YEARS
EXPERIENCE
IN THE ASHP
MARKET

• BRACKETS
& TRAYS



• TRUNKING

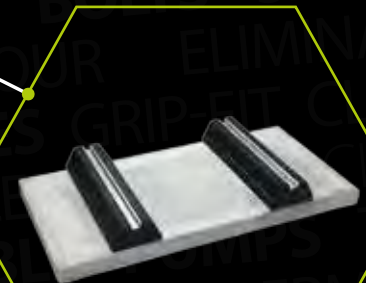

• SLAB KIT

SEE PAGE 93

OTHER PUMPS



INDUSTRIAL PUMPS



PARTS WASHER PUMP 1Y-PW (501027) PE2-YSA (14940101)

Submersible, unpainted, aluminium housing pumps with Viton® seals, 1/4" MNPT discharge, master builders conduit fitting. The PE pumps have an epoxy encapsulated motor.



1Y-PW



PE2-YSA

Part code	Brand	Description	Max Head	Max Flow	Dimensions mm (HxWxD)	Discharge Size (inch)	Weight
1Y-PW	Little Giant	Parts Washer Pump	2m	800LPH	117x109x104	1/4" MNPT	1.6kg

Part code	Brand	Description	Max Head	Max Flow	Dimensions mm (HxWxD)	Discharge Size (inch)	Weight
PE2-YSA	Little Giant	Small Submersible Pump	3.8m	1135LPH	142x137x73	1/4" MNPT	2kg

POOL COVER PUMPS

POOL COVER PUMP - APCP-1700 (577309)

Little Giant Pool Cover Pumps help safeguard and protect the pool cover from prolonged accumulation of rain or melting snow. This automatic version is certified for use

on pool covers, all of which can attach to a standard garden hose for easy water removal. It removes standing water from pool covers and is ideal for household water transfer applications.



Part code	Brand	Description	Max Head	Max Flow	Dimensions mm (HxWxD)	Discharge Size (inch)	Weight
APCP-1700	Little Giant	Automatic Pool Cover Pump	6.6m	6814LPH	210x305x305	1" FNPT	5.4kg

SUBMERSIBLE PUMPS

LG SEMI SUBMERSIBLE CONDENSATE PUMP

Part code	Brand	Description	Weight
1-ABS	Little Giant	LG Semi Submersible Condensate Pump	1.92kg



MAGNETIC DRIVE PUMPS - MD-SC/ MD-HC SERIES

Little Giant magnet driven pumps feature a leak proof design that allows the pumps to be used in a variety of applications where continuous and reliable operation is desired and when pumping corrosive liquid is necessary.

The MD-SC Series is designed to pump mild to strong acids found in electroplating applications with temperatures up to 66°C. The MD-HC series can pump strong acids and alkaline solutions, including sulphuric nitric and hydrochloric acid with temperatures up to 93°C. In addition, the HC series offers "Run Dry" protection.



Part code	Brand	Description	Max Head	Max Flow	Liquid temp in °C	Inlet Size (inch)	Discharge size (inch)
TE3-MD-SC	Little Giant	Magnetic Drive TE3 Series Pump	3.5m	1980LPH	66°C	1" FNPT	1/2" MNPT
TE3-MD-HC	Little Giant	Magnetic Drive TE3 Series Pump	3.5m	1980LPH	93.3°C	1" FNPT	1/2" MNPT
TE4-MD-SC	Little Giant	Magnetic Drive TE4 Series Pump	4.9m	2940LPH	66°C	1" FNPT	1/2" MNPT
TE4-MD-HC	Little Giant	Magnetic Drive TE4 Series Pump	4.9m	2940LPH	93.3°C	1" FNPT	1/2" MNPT
TE5-MD-SC	Little Giant	Magnetic Drive TE5 Series Pump	6.2m	3660LPH	66°C	1" FNPT	1/2" MNPT
TE5-MD-HC	Little Giant	Magnetic Drive TE5 Series Pump	6.2m	3660LPH	93.3°C	1" FNPT	1/2" MNPT
TE5.5-MD-SC	Little Giant	Magnetic Drive TE5.5 Series Pump	8.8m	6120LPH	66°C	1" FNPT	3/4" MNPT
TE5.5-MD-HC	Little Giant	Magnetic Drive TE5.5 Series Pump	8.8m	6120LPH	82.2°C	1" FNPT	3/4" MNPT
TE6-MD-SC	Little Giant	Magnetic Drive TE6 Series Pump	10.7m	7500LPH	66°C	1" FNPT	3/4" MNPT
TE6-MD-HC	Little Giant	Magnetic Drive TE6 Series Pump	10.7m	7500LPH	82.2°C	1" FNPT	3/4" MNPT
TE7-MD-SC	Little Giant	Magnetic Drive TE7 Series Pump	12.3m	9540LPH	66°C	1-1/2" FNPT	1" MNPT
TE7-MD-HC	Little Giant	Magnetic Drive TE7 Series Pump	12.3m	9540LPH	93.3°C	1-1/2" FNPT	1" MNPT

INABA DENKO



SLIMDUCT Precision created for the trade!

*Designed for professionals who
value both quality and finish.*



CUSTOMISE YOUR INSTALL
WITH **SLIMDUCT**

CHOOSE FROM

- 5 COLOURS (WHITE, IVORY, BROWN, BLACK AND ANTHRACITE GREY)
- 3 SIZES (75, 100 AND 140MM)
- UP TO 22 FITTINGS



DISTRIBUTED IN
THE UK BY

DIVERSITECH
INTERNATIONAL

sales@diversitech.com
www.diversitech.global

FIND OUT MORE

BOILER & HEATING

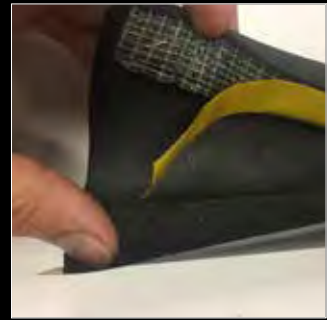

BOILER CONDENSATE PUMPS



TANK PUMPS

DiversiTech stock a range of boiler condensate removal pumps that are ideal when the boiler condensate can not be removed via gravity. The tank pumps use a small bore of flexible hose which can be routed above or below doors, windows or under kitchen cabinets.

When routing hose through any area which could be exposed to freezing temperatures, such as lofts, basements or garages, we strongly recommend increasing to at least 32mm plastic pipe and insulating.



Part code	Brand	Description	Max head	Max flow	Drink cycle	Dimensions mm (HxWxD)	Discharge Size (inch)
PH-0.8LC	Pump House	0.8 Litre Tank Pump with Cover	3m	150LPH	200ml	128x210x86	9.5mm (3/8)
PH-0.8L-HL	Pump House	0.8 Litre Tank Pump	6.8m	456LPH	300ml	141x220x134	6.35mm (1/4") 9.5mm (3/8)
PH-20-STA	Pump House	2 Litre Tank Pump	5.5M	402LPH	650ML	166x286x135	9.5mm (3/8)

CONDENSATE NEUTRALISERS

COMMERCIAL CONDENSATE NEUTRALISER - 20 & 30 LITRES

Installing a neutraliser will reduce the impact of damage to existing boiler concrete drainage gullies and allow for the condensate to be disposed of safely.

The 20-litre stainless steel version can handle condensate from boilers up to 600kW by gravity.

The 30-litre version comes complete with a pump to provide a 5.9 metre lift and a flow rate of up to 900 litres per hour. Both come with lime chippings for instant installation and are suitable for 2.8pH boiler condensate.



BCONDNEUT-20L*

BCONDNEUT-30L*

Part code	Brand	Description	Tank capacity	Dimensions mm (HxWxD)	Discharge Size (inch)	Inlet	Weight
BCONDNEUT-20L	Pump House	20 Litre with lime chippings	20L	200x400x300	9.5mm (3/8)	40mm	27kg
BCONDNEUT-30L	Pump House	30 Litre with pump & lime chippings	30L	200x550x305	9.5mm (3/8)	40mm	30kg

* Modular & bespoke designs are available for boilers over 600kW.

PRVSURE PRV & CONDENSATE PUMP

This pump is manufactured from high temperature plastic, and comes complete with 10m of higher specification hose.

It meets EN Standards and can handle temperatures up to 110 degrees. Supplied with 10 metres of

'no sag' high grade braided hose. The unique design also cools the PRV discharge so it is safe for use with solvent weld pipework. For installers who are audited or working to EN Standards.

PRV*Sure*



PH-3.8L-HW

Part code	Brand	Description	Max head*	Max flow	Temp	Dimensions mm (HxWxD)	Discharge Size (inch)
PH-3.8L-HW	Pump House	High Temperature & Pressure Relief Pump	8m / 20m	32 LPM (1920LPH)	100°C	350x190x260	15mm

* meeting BS6798:2014 PRV requirements

HIGH TEMPERATURE PRESSURE RELIEF PUMP - PH-5L-HW

Designed for unvented cylinder T&P discharge and steam humidifiers. Having one of the largest discharge rates of 32 litres per minute this pump can handle both high temperature up to 100 degrees and high flow rates.

Manufactured in the UK this heavy duty, high temperature tank pump incorporates thermal overload protection and a high level alarm switch.



PH-5L-HW



IN SITU

Part code	Brand	Description	Max head*	Max flow	Temp	Dimensions mm (HxWxD)	Discharge Size (inch)
PH-5L-HW	Pump House	High Temperature & Pressure Relief Pump	8m / 20m	32 LPM (1920LPH)	100°C	350x190x260	15mm

* Max Heads - 8 metre for flow rates up to 25 Litres per minute / 20 metre for flow rates of 5 Litres per minute



SUBMERSIBLE DRAINAGE BASEMENT PUMP

Little Giant have the perfect pump solution for the removal of clean, non-aggressive residual water. This pump can be used to assist with the extraction of flood water in properties with basements and can be used with a sump to provide the removal of water below floor level.



Part code	Brand	Description	Max head	Max flow	Dimensions mm (HxWxD)	Discharge size	Weight
6E-CIA-SFS	Little Giant	Drainage Basement Pump	4.6m	9600LPH	258x269x213	38mm (1/2)	12.7kg

SWIMMING POOL COVER PUMP - APCP-1700

The Little Giant APCP pool cover pump helps safeguard and protect the pool cover from prolonged accumulation of rain or melting snow. This automatic version is certified for use on pool covers, all of which can attach to a standard garden hose for easy water removal.

It removes standing water from pool covers and is ideal for household water transfer applications.

APCP-1700



Part code	Brand	Description	Max head	Max flow	Dimensions mm (HxWxD)	Discharge size	Weight
APCP-1700	Little Giant	Automatic Pool Cover Pump	6.6m	6814LPH	210x305x305	1" FNPT	5.4kg

SOAKAWAY AND CONDENSATE BYPASS VALVE



SOAKAWAY KIT FOR CONDENSING BOILERS

'Soak up' boiler condensate with our soakaway. Where a suitable gravity drain is not available the soakaway can be used in conjunction with 10mm lime chippings.

Compatible with the following pipe sizes: 22mm (3/4") overflow, 32mm (1-1/4") and 40mm (1-1/2").



TOP VIEW

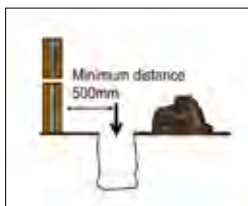

1. DIG HOLE (MIN DEPTH) 400MM X 300MM IN DIAMETER, AT LEAST 500MM FROM THE WALL

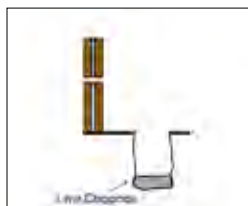

2. FILL THE BOTTOM OF THE HOLE WITH 100MM DEPTH OF LIME CHIPPINGS.

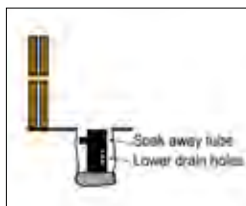

3. INSERT THE SOAKAWAY TUBE WITH THE LOWER DRAIN HOLES FACING AWAY FROM THE PROPERTY.

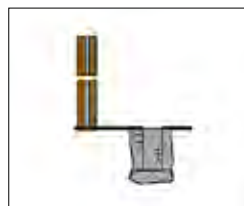

4. FILL THE REMAINING PART OF THE HOLE AND TUBE WITH LIME CHIPPINGS

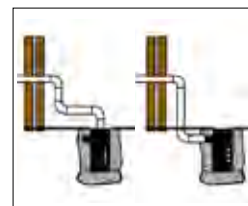

5. FEED THE PIPEWORK EITHER INTO THE TOP OR THROUGH THE SIDE OF THE SOAKAWAY.

Part code	Description	Height	Diameter	Inlet (inch)
SOAK1	Soakaway Kit for Condensing Boilers	300mm	110mm	22mm (3/4) 32mm (1-1/4) 40mm (1-1/2)

FREEZING CONDENSATE SOLUTION BOILER BUOY CONDENSATE BYPASS VALVE

Low cost, easy to install solution to bypass freezing pipes. Cutting a condensate pipe due to freezing has been common place over winter periods. The BB-1 Boiler Buoy condensate bypass valve is a solution that has been designed to be fitted during install, emergency call outs or whilst performing annual service visits.

A red float which when visible, indicates that the condensate pipe has a blockage or may be frozen.

The built in tap allows the householder to drain the condensate away safely and ensures that the heating of the property can continue to work.



Part code	Description	Height	Diameter	Outlet	Hose Length
BB-1	Boiler Buoy - Condensate Bypass Valve	115mm	29mm	9.5mm	1.5m

ACCESSORIES

DiversiTech International stock a range of adaptors,, connectors, clamps, clips and hoses to connect the unit and pump.



Part code	Description	Pump type application	Pack QTY
adap-1	Condensate drain adaptor - 22mm to 9.5mm (7/8 to 3/8")	Tank pump - 9.5mm (3/8") outlet	Single
ph-pump-nrv	Non-return check valve - 9.5mm (3/8")	Tank pump - 9.5mm (3/8") outlet	Single
anti-syph-kit	Anti Syphon Kit - 9.5mm (3/8")	Tank pump - 9.5mm (3/8") outlet	Single
701-032	Hose connector - Nylon 9.5mm (3/8")	Tank pump - 9.5mm (3/8") outlet	2-pack
b-6h	Hose clamp - 6.3mm - 9.5mm (1/4 - 3/8")	All pumps	Single
927033	Hose clip - 9.5mm (3/8")	Tank pump - 9.5mm (3/8") outlet	Single
rvt-3/8	Condensate drain hose - 9.5mm (3/8")	Tabnk pump / hot water pumps	30m

SELF-SEALING PIPE ADAPTOR

The self-sealing adaptor is used to form a connection between condensate hose and a soil & vent pipe. Drill a 13mm hole (for SVA-3) or a 10mm hole (for SVA-6), insert and twist in to seal the connection.



Part code	Description	Pack QTY
SVA-3	Self-sealing pipe adaptor - 6mm & 9.5mm (1/4 & 3/8) hose to soil & vent pipe	3 Pack
SV-ADAPTOR	Self-sealing pipe adaptor - 6mm & 9.5mm (1/4 & 3/8) hose to soil & vent pipe	Single
SVA-6-3	Self-sealing pipe adaptor - 6mm (1/4) hose to soil & vent pipe	3 pack
SV-ADAPTOR-6	Self-sealing pipe adaptor - 6mm (1/4) hose to soil & vent pipe	Single

AUDIBLE ALARM

This audible alarm can be wired into all pumps with a high level switch.



Part code	Description	Pack QTY
audible-alarm	Audible alarm for all pumps with a high-level switch	Single

PORTABLES



A energy efficiency

PORTABLES - COOL ONLY & HEAT / COOL PUMP

The portable air conditioners are suitable for offices, computer rooms and light commercial use. The cooling only model is ideal for cooling flats, conservatories or loft conversions during hot summer months. The heat and cool model can be used as an energy efficient form of heating along with cooling. The units come with a hose, tray, remote control and wall kit. Spare parts are available upon request - please enquire for more details.

PAC-C-12-R290



Part code	Description	Cool capacity Btu/kW	Heat capacity Btu/kW	Watts	Amps	Air flow volume	EER	COP	Sound power level dBA
PAC-C-12-R290	Portable (cooling)	12,000 / 3.5	N/A	1350	5.9	420m ³ /h	2.6	N/A	56
PAC-H-12-R290	Portable (heat pump)	12,000 / 3.5	N/A	1350	5.9	420m ³ /h	2.6	N/A	56

Part code	Description	Height	Width	Depth	Weight	Hose length	Refrigerant	Cooling area
PAC-C-12-R290	Portable (cooling)	730mm	485mm	360mm	28kg	1.5m	R290	25-30m ²
PAC-H-12-R290	Portable (heat pump)	730mm	485mm	360mm	28kg	1.5m	R290	25-30m ²

PAC-IHP-12-BLK

The all new PORTABLE AC (heat & cool) is now available in a sleek black finish. This unit has a A++ cooling energy class rating, and when winter arrives, the heating output has an A+++ heating energy class.

- NEW black colour
- A++ cooling energy class rating
- A+++ heating energy class rating
- Uses 25% less power than non inverter unit
- R290 refrigerant



Part code	PAC-IHP-12-BLK-A++
power supply	220-240V
Hz	50
water tank volume	1.2L
cooling capacity	3500W
cooling energy class	A++
heating capacity	2930W
heating energy class	A+++
moisture removal	1.6 LPH
SOUND	64/63/62 dB(A) (58 dB(A) sleep)
refrigerant	R290
charge	0.23kg
gwp	3
CO2	0.00069
suction pressure	1.2 Mpa
discharge pressure	2.3 Mpa
rated power	1100W
rated current	6.8A
Weight	31.1kg
gross weight	35.3kg
dimensions	450 (W) x 396 (D) x 745 (H)mm
packing dimensions	499 (W) x 459 (D) x 880 (H)mm
amps	0.7A

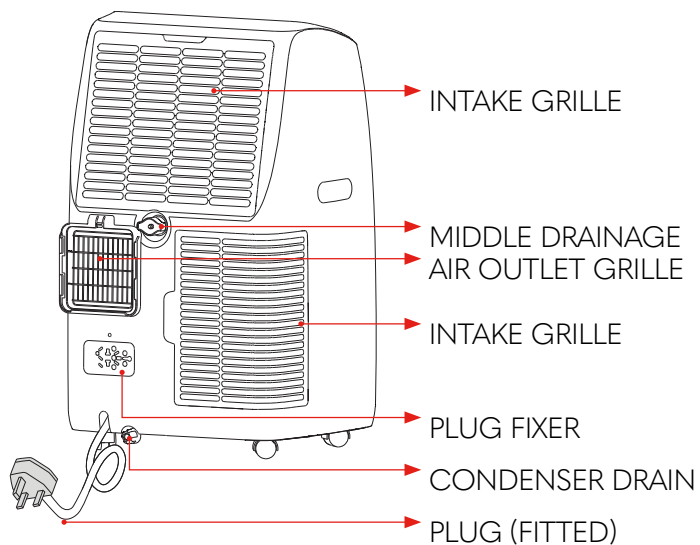
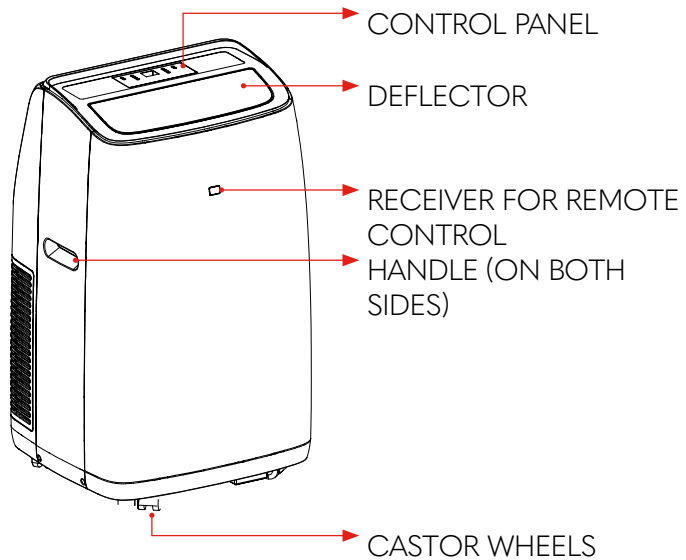

TORCHES



CLIPLIGHT - PIVOT™ TORCHES

The Pivot™ range has a 360 degree swivel hook and is magnetic at the base and back. Available in colours Yellow/Black and Camo. All models are supplied with three AAA batteries.



Part code	Description	Colour	Lumens	UOM	Master QTY
111114	Pivot - 5 LED Work Light	Yellow/Black	240	Each	Pack of 9
111115	Pivot Mini - 18 LED Front Light / 3 LED Top	Yellow/Black	120	Each	Pack of 12
111117	Pivot Mini - 18 LED Front Light / 3 LED Top	Camo	120	Each	Pack of 12
24-458	Pivot 33 - 28 LED Front Light / 5 LED Top	Yellow/Black	160	Each	Pack of 9
24-460	Pivot 33 - 28 LED Front Light / 5 LED Top	Camo	160	Each	Pack of 9

TAPES



ABRASIVE CLOTH

A high quality aluminium oxide 120 grit abrasive cloth, that can be used wet or dry to thoroughly clean steel and copper tubing.



Part code	Description	UOM	Master Qty
SC-10	Abrasive Cloth - 120 Grit - 1-1/2" x 10 yards	1	1

GRIP-CUT CLOTH

A 180 grit open mesh sand screen cloth with aluminium oxide bonding, that is 100% waterproof. Can be used by hand or with portable tools and is most effective where clogging would be a problem such as soft materials.



Part code	Description	UOM	Master Qty
SCM-5	Grip- Cut Open Mesh Sand Screen Cloth - 1-1/2" x 5 yards	1	1

BRAZE BARRIER MATS

This flame barrier drop cloth withstands temperatures to (1600°C) 3000°F No asbestos. Protects walls, floors, equipment, components and adjacent surfaces from torch flames when soldering, brazing or welding.



Part code	Description	UOM	Master Qty
16500	Plain Braze Barrier Mat 18" x 18"	1	1
16510	Keyhole Braze Barrier Mat - 18" x 18"	1	1

SWITCHES AND ISOLATORS

FUSED SPUR SWITCHES

Part code	Description
X-FSBBMC	Fused Spur Metal Clad - with Back Box
X-FSNBBMC	Fused Spur Metal Clad - with Back Box & Neon
X-FS	Fused Spur Plastic - without neon
X-FSN	Fused Spur Plastic - with neon
X-BBSM-25	Back Box Surface Mount - 25mm
X-BBSM-35	Back Box Surface Mount - 35mm
X-BBSM26-25	Back Box 2 Gang - 25mm
X-BBSM2G-35	Back Box 2 Gang - 35mm
X-BSPS-10A	Plug Socket - 10 Amp
X-2GSW2W-10A	Switch 2 Gang - 10 Amp
X-3GSW2W-10A	Switch 3 Gang - 10 Amp
X-1GDPSW-13A	Switch 1 Gang - 13 Amp
X-2GDPSW-13A	Switch 2 Gang - 13 Amp
X-DPSW-20A	Switch Double Pole - 20 Amp
X-PT	Plug Top - 13 Amp



FUSED SPUR METAL



FUSED SPUR PLASTIC

SERVICE AND MAINTENANCE

DRAINGUN

Blocked drain line - no problem with our DrainGun™. This lightweight, portable tool is designed to unblock condensate drain lines and other pipework instantly.

Simply insert a CO² cartridge in to the DrainGun and with a press of the trigger, SWOOSH, 800 psi of food grade CO² blows the blockage out.



Part code	Description	Size
GG-1	Drain Gun Line Cleaner	Single Pack
GGC-6	Drain Gun - Pack of 6, CO ² Cartridges	Pack of 6
GG-1A	Drain Gun - Adaptor Kit - for larger tubes, oil lines and 90 degree angles	3 adaptors
GG-1H	Drain Gun - Hose Assembly	Single Pack

VORTEX MAP-X BRAZING GAS

Map-X burns hotter than Vortex Propane, which makes it ideal for high-temperature applications. Sold in 400g non-refillable canister. Vortex gases are designed for use with any of our Vortex range of brazing torches.



Part code	Description	Size
VG1	Vortex Map-X gas cannister	400g

ACCESSORIES



EXPANDING FOAM SEALANT

A one component closed-cell expanding polyurethane foam sealant that is tack free in 20 minutes. Can be painted to prevent UV damage after 12 hours of drying time. Used to seal around doors, windows, pipes, ducts and vents - in fact, virtually anywhere.



Part code	Description	UOM	Master Qty
FOAM-152760	Gap filler expanding foam - 300ml	Each	12
FOAM-135234	Gap filler expanding foam - 600ml	Each	12

SILICONE SEALANTS

Available in clear or white, DiversiTech silicone sealants are 100% food grade and can be used in applications for continuous use up to 232°C. It is UV and water resistant and has long term flexibility.



Part code	Description	UOM	Master Qty
7-4000	Clear Silicone Sealant - 305ml	Each	12
7-4100	White Silicone Sealant - 305ml	Each	12

DIVERSI-GUM SEALING COMPOUND

Diversi-Gum is a non-hardening, non-corrosive sealing compound that is immediately paintable and has a temperature usage range between -4°C and 49°C. It is ideal for sealing openings through walls from pipework.



Part code	Description	UOM	Master Qty
6-202-1	Diversi-Gum Sealing compound 450g slug	Each	24
6-202-2	Diversi-Gum Sealing compound 900g slug	Each	20

DIVERSI-BOND

Diversi-Bond is a versatile, strong elastic adhesive and sealant for use in bonding and sealing applications in the construction industry. Ideal for air conditioning, plumbing and ventilation sectors where a tough flexible rubber joint and a powerful elastic adhesive bond is required.

- Waterproof and UV-stable
- Expands and contracts with temperature variants (-40°C - +100°C)
- Long-lasting protection against moisture ingress
- Solvent and isocyanate free



Part code	Description	Size	Colour
DIVERSI-BOND	Sealant adhesive for insulation	290ml	Black

COOL-WELD™ HEAT BARRIER SPRAY

Cool-Weld™ is a spray on gel heat shield for soldering, sweating and welding. Ideal for use on filter driers, pipes, valves, sheet metals, etc. Can be used on porous surfaces such as fabrics or drywall. As long as there is some Cool-Weld™ present the surface will resist charring.



Part code	Description	UOM	Master Qty
COOLWELD-32	Cool-Weld Heat Barrier Spray - 32oz with spray top	Each	12

TELESCOPIC INSPECTION MIRRORS

Fast, accurate visual inspection of hidden areas with an almost limitless number of positions. Double ball joint links swivel mirrors for viewing 360 degrees. Precision engineered links are made from tempered spring steel to withstand the stresses of constant repositioning. Moves freely and holds in the desired position.



Part code	Description	Qty
M-1	Mirror 1-1/4" circular - extends 32mm - 463mm (6-1/4" to 18-1/4")	1
M-2	Mirror 57mm (2-1/4") circular - extends 254mm - 355mm (10" to 14")	1
M-3	Mirror 54mm x 183mm (2-1/8" x 3-1/2") rectangular - extends 285mm - 387mm (11-1/4" to 15-1/4")	1
M-4	Mirror 22mm (7/8") Circular - extends 165mm (6 -1/2")	1
M-5	Mirror 25mm x 50mm (1" x 2") Oval - extends 191mm (8-1/2")	1

WYPALL CLOTHS

Heavy duty towels that absorb grease, oil, water and solvents from floors, hands, parts, tools and machinery.



Part code	Description	UOM	Master Qty
5-05790	WypAll Plus Towels - White	Each	Box of 9

PLASTIC PIPE FITTINGS



STRAP ON BOSS

Using a Strap On Boss allows you to add condensate drain pipe to a soil and vent pipe. For adding a waste connection into an existing PVCu and cast iron soil pipe. For use with 32mm or 40mm pipes. Must be solvent welded into position.



Part code	Description	Colour	Quantity
PP-SOBOSS-110-G-32	Strap On Boss - 110mm Pipe with 32mm (1-1/4") Rubber	GREY	1
PP-SOBOSS-110-G-40	Strap On Boss - 110mm Pipe with 40mm (1-1/2") Rubber	GREY	1
PP-SOBOSS-110-B-32	Strap On Boss - 110mm Pipe with 32mm (1-1/4") Rubber	BLACK	1
PP-SOBOSS-110-B-40	Strap On Boss - 110mm Pipe with 40mm (1-1/2") Rubber	BLACK	1
X-PVCU-SOBSC-110MM	Strap On Boss - 110mm PVCU		10

PVC PIPES

PVC-U - ELBOW 3/4" 90 DEGREE



PVC-U - 3/4" T PIECE



PVC-U - 3/4" SOCKET



PVC-U - 3/4" MACLOW CLIPS



Part code 3/4"	Part code 1"	Part code 1-1/4"	Description	Quantity
X-PVCU-3/4E-45		X-PVCU-1-1/4E-45	PVCU - Elbow - 45 Degree	10
X-PVCU-3/4-45T		X-PVCU-1-1/4-45T	PVCU - 45 Degree T	10
X-PVCU-3/4E-90	X-PVCU-1E-90	X-PVCU-1-1/4E-90	PVCU - Elbow - 90 Degree	10
X-PVCU-3/4-MAC	X-PVCU-1-MAC	X-PVCU-1-1/4-MAC	PVCU - MacLow Clips	10
X-PVCU-3/4-EC			PVCU - End Cap	10
X-PVCU-3/4P-3M	X-PVCU-1P-3M	X-PVCU-1-1/4-3M	PVCU - Pipe - 3 Metre Length	10
X-PVCU-3/4-SOC	X-PVCU-1-SOC	X-PVCU-1-1/4-SOC	PVCU - Socket	10
X-PVCU-3/4-CAP		X-PVCU-1-1/4-CAP	PVCU - Threaded Cap	10
X-PVCU-3/4-PIN		X-PVCU-1-1/4-PIN	PVCU - Pin / Barrel	10
X-PVCU-3/4-R		X-PVCU-1-1/4-R	PVCU - Reducer	10
X-PVCU-3/4-RE		X-PVCU-1-1/4-RE	PVCU - Rodding Eye	10
X-PVCU-3/4-TP	X-PVCU-1TP	X-PVCU-1-1/4-TP	PVCU - T Piece	10

PLASTIC PIPE FITTINGS



Code White	Code Black	Description	Pipe Size (mm)	Quantity
PP-90EL-21.5-W	PP-90EL-21.5-B	Plastic Pipe - 90 Degree Elbow	21.5mm	Pack of 10
PP-45EL-21.5-W	PP-45EL-21.5-B	Plastic Pipe - 45 Degree Elbow	21.5mm	Pack of 10
PP-CON-21.5-W	PP-CON-21.5-B	Plastic Pipe - Straight Connector	21.5mm	Pack of 10
PP-T-21.5-W	PP-T-21.5-B	Plastic Pipe - T Connector	21.5mm	Pack of 10
PP-PIPE-21.5-W	PP-PIPE-21.5-B	Plastic Pipe	21.5mm	3 metre

"Code White"	"Code Black"	"Code Grey"	Description	"Pipe Size (mm)"	Quantity
PP-CL-15-W			Plastic Pipe Clip	15mm	Pack of 100
PP-CL-22-W	PP-CL-22-B100		Plastic Pipe Clip	22mm	Pack of 100
PP-CL-28-W			Plastic Pipe Clip	28mm	Pack of 100
PP-CL-32-W	PP-CL-32-B	PP-CL-32-G	Plastic Pipe Clip	32mm	Pack of 10
PP-CL-40-W	PP-CL-40-B	PP-CL-40-G	Plastic Pipe Clip	40mm	Pack of 10

Code	Description	Size	Master QTY
PVCC250	Solvent Cement	250ml	20

PLASTIC PIPE CLAMPS / NON-RETURN VALVES

Our plastic pipe clamps are designed to connect overflow or waste hose pipe to an existing 32mm (1-1/4") or 40mm (1-1/2") pipe. To avoid waste water flowing back up the pipework our non-return valves can be used on overflow pipe or waste hose pipe.

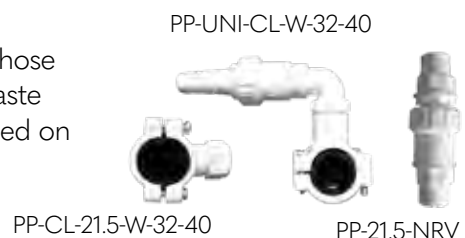

Part code	Description	Quantity
PP-CL-21.5-W-32-40	Pipe Clamp Kit - 21.5mm overflow to 32mm (1/1/4") and 40mm (1-1/2")	1
PP-UNI-CL-W-32-40	Pipe Clamp - Hose Connector 32mm (1-1/4") and 40mm (1-1/2")	1
PP-21.5-NRV	Non-Return Valve - for 21.5mm overflow pipe	1
PP-UNI-NRV	Non-Return Valve - with Hose Fitting	1

THIS JOB TAKES SOME THICK SKIN.

LUCKILY, OUR HOSES HAVE IT.

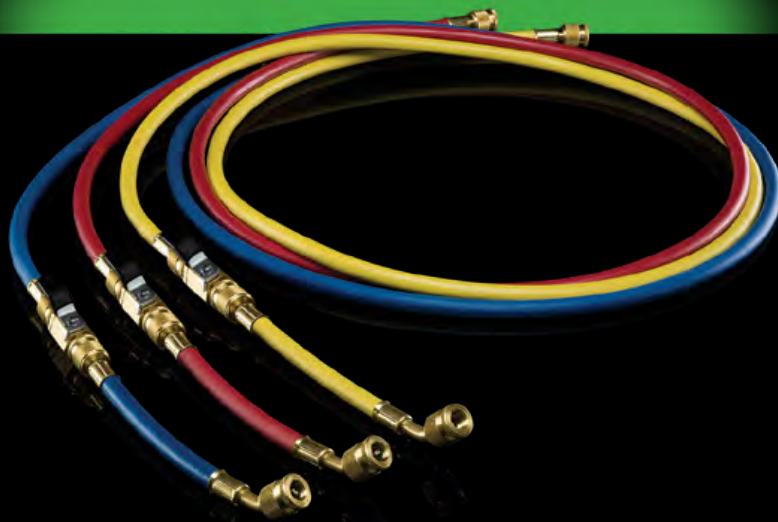

If you can stand the pressure, your hoses should, too. We've rethought and retooled the hoses you use every day with smart features like an extra abrasion-resistant layer for superior protection in tough conditions. All of our Hoses are rated for 800 PSI working pressure to work with the newest high-pressure refrigerants. Simply select the Hose and Ball Valves you need. You can choose from Hoses and Ball Valve Adapters individually, or buy them as a set.

AIR SOURCE HEAT PUMPS INSTALLATION PRODUCTS



ARE YOU GETTING 100% OF
HEAT INTO YOUR PROPERTY

INSTALLING



WALL MOUNTING BRACKETS

BASIC COLOUR RAL 7032

Our Type-2 brackets come with a cross-bar to allow for correct spacing of the arms. An integral spirit level allows for easier installation. All brackets go through a 4-stage anti-corrosion process. *



WEATHER PROTECTION PROCESS	
	PROCESS 1 CORROSION RESISTANT RAW MATERIAL, OFTEN REFERRED TO AS ZINTEC
	PROCESS 2 ZINC PHOSPHATING PROCESS MULTI STAGE CLEANING AND DIPPING CHEMICAL ZINC
	PROCESS 3 ELECTROPHORETIC DEPOSITION (AKA ED OR EPD) COATING
	PROCESS 4 EPOXY POLYESTER POWDER COATING

IVORY (RAL 7032)

Part code	Description	Safe working load*	Max load	Crossbar	Upright	Support arm	Weight
CBR2-S	Type 2 Bracket - Small	60kg	120kg	720mm	400mm	400mm	3.8kg
CBR2-M	Type 2 Bracket - Medium	90kg	180kg	900mm	500mm	500mm	4.6kg
CBR2-L	Type 2 Bracket - Large	140kg	280kg	1040mm	550mm	540mm	6.6kg
CBR2-XL	Type 2 Bracket - XL	250kg	500kg	1040mm	550mm	660mm	16.2kg
CBR2-XXL	Type 2 Bracket - Double XL	200kg	400kg	1040mm	550mm	780mm	17.3kg

BLACK

Part code	Description	Safe working load*	Max load	Crossbar	Upright	Support arm	Weight
CBR2-XL-BL	Type 2 Bracket - XL	250kg	500kg	1040mm	550mm	660mm	16.2kg
CBR2-XL-3A-BL	Type 2 Bracket - XL (3 arms)	250kg	500kg	1040mm	550mm	660mm	16.2kg
CBR2-XXL-BL	Type 2 Bracket - XL	200kg	400kg	1040mm	550mm	780mm	16.5kg
CBR2-XXL-3A-BL-DA	Type 2 Bracket - Double XL (3 arms)	200kg	400kg	1120mm	550mm	780mm	17.3kg

* All brackets are tested to 2 x safe working load.

NB: Sea salts are very corrosive and affect both ferrous and non-ferrous metals. Coastal installations are particularly at risk as they are frequently exposed to sea salt solutions followed by dry periods, where this wet/dry cycle produces a very corrosive environment. We strongly recommend that in such locations only our stainless steel brackets are installed.

EASY-FIT CONDENSATE TRAYS

BASIC COLOUR RAL 7032

Concave profile to ensure efficient drainage. Supplied with fixing arms to mount to bracket. All trays go through a 4-stage anti-corrosion process (see **WEATHER PROTECTION PROCESS**). All trays are 25mm high.



Part code	Description	Depth	Width	Weight
CCTM-800	Metal tray - small	400mm	800mm	5.23kg
CCTM-1080	Metal tray - 1080mm	500mm	1080mm	7.5kg
CCTM-1100	Metal tray - medium	400mm	1100mm	6.9kg
CCTM-1300	Metal tray - 1300mm	550mm	1300mm	8.8kg
CCTM-1400	Metal tray - large	400mm	1400mm	8.3kg

Part code	Description	Width	Length	Weight
CCTM01420-BL	Metal tray	500mm	1420mm	8.5kg

FLEXI LITE SLAB AND FOOT KIT

A low cost innovative solution for floor mounting heat pumps. The FLEXI Lite Slab and Foot kits avoid the high cost and time consuming need to construct a concrete base. Each kit comes complete with FLEXI rubber mounting feet, an Ultralite slab, and all the fixings. It can be delivered to site with minimum preparation and can be assembled in minutes. The Ultralite slab is a heavy duty slab with a polystyrene core and a fibre reinforced concrete coating. This makes the slab a fraction of the weight of a traditional concrete slab.



POSITION SLAB IN REQUIRED POSITION



POSITION FEET ON SLAB TO MATCH PITCH OF UNIT



INSERT ALL 4 BASE PLATES THROUGH THE SLAB



PLACE BOTH FEET OVER BASE PLATE THREADS



KIT IS COMPLETE AND READY FOR UNIT

Part code	Description	Specifications (WxDxH)
FF-UC3-S	Flexi Lite Kit - small	900 x 600 x 175
FF-UC3-M	Flexi Lite Kit - medium	1050 x 600 x 175
FF-UC3	Flexi-Lite Slab Kit	1200 x 600 x 175
FF-UC3-3	Flexi lite Slab Kit - 3 FEET	1200 x 600 x 175
FF-UC3-XL	Flexi-Lite Slab Kit - extra large	1650 x 865 x 175
FF-UC3-3XL	Flexi-Lite Slab Kit - 3 FEET - extra large	1650 x 865 x 175
FF-UC3-3XL-150	Flexi-Lite Slab Kit - 3 FEET (150mm feet) - extra large	1650 x 865 x 225

INSTALLING



FLEXI FOOT - SINGLE

Flexi Foot with 41mm galvanised Steel channel.



Part code	Size L x W x H mm	Weight	Safe working load
FF-250-S	250x185x100	2.8kg	175kg
FF-400-S	400x185x100	4.6kg	280kg
FF-600-S	600x185x100	7.6kg	420kg
FF-600-S-150	600x162x150	7.2kg	420kg
FF-1000-S	1000x185x100	12kg	700kg

FLEXI FOOT KITS

2 x Flexi feet with fixings pack.



Part code	Description
FF-400-S-KIT	FLEXI-FOOT Kit - 400 (2 x 400mm feet + fixing kit)
FF-600-S-KIT	FLEXI-FOOT Kit - 600 (2 x 600mm feet + fixing kit)
FF-600-S-KIT-3	FLEXI-FOOT Kit - 600 (3 x 600mm feet + fixing kit)
FF-600-3-ASN-KIT	FLEXI-FOOT Kit - 600 narrow (3 x FF-600-ASN + fittings kit)
FF-600-S-150-KIT	FLEXI-FOOT Kit - 600 x 150 high (2 x 600mm x 150mm feet + fixing kit)
FF-600-S-150-KIT-3	FLEXI-FOOT Kit - 600 x 150 high (3x 600mm x 150mm feet + fixing kit)
FF-1000-S-KIT	FLEXI-FOOT Kit - 1000 (2 x 1000mm feet + fixing kit)

BABY SUMO RUBBER ADJUSTABLE SUPPORT FOOT

These mini adjustable feet are perfect as ground supports for AC and ASHP units. They are made from reprocessing discarded tyres where 70-95% of the rubber can be recovered. These feet are made of a blend of SBR vulcanised UV-stable rubber with internal glass fibre-reinforced polypropylene.

NB: THERE IS A 15° ANGLE OF ADJUSTMENT AT THE FIXING POINT



Part code	Description	Height (B)	Width (A)	Depth (C)	Safe working load	Fixing (D)	QTY
SUMO-FT	Mini adjustable foot	160-210mm	160mm	160mm	150kg (per foot)	M10	Pack of 4
SUMO-FT-6	Mini adjustable foot	160-210mm	160mm	160mm	150kg (per foot)	M10	Pack of 6

ANTIFREEZE VALVES

Antifreeze valves are used to prevent the formation of ice in the circuit of a system, avoiding possible damage to the machine and pipes. The antifreeze valve allows the fluid to be discharged from the circuit when its temperature reaches an average value of 3 °C.

AF-1-1-MALE



AF-1SWVF-1-MALE



AF-28-28-COMP



- Operating temperature: 0 ÷ 90°C
- Nominal Pressure: PN 10
- Fluid temperature (opening): 3°C
- Fluid temperature (closing): 4 °C
- Made of brass alloy compliant with

- EN 12165-CW617N-DW standard.
- 100% tested according to EN 12266-1.
- Made in compliance with the management requirements of the EN ISO 9001 standard.

Part code	Description	Information
AF-1-1-MALE	ANTIFREEZE VALVE	1" X 1" BSP MALE FITTING
AF-1SWVF-1-MALE	ANTIFREEZE VALVE WITH SWIVEL NUT	1" SWIVEL FLAT-FACE FEMALE X 1" BSP MALE FITTING
AF-28-COMP	DOUBLE-CONE ANTIFREEZE VALVE	28 X 28 COMPRESSION FITTING

BALL VALVES

Full bore long-stem 28mm compression ball valve with nickel-plated brass valve body and red handle to be used in water applications



WITH INSULATION SLEEVE

DESIGNED BY DIVERSITECH FOR AIR SOURCE HEAT PUMP INSTALLS

- Connection: Compression
- Material: Nickel-plated brass
- Working temperature: -10°C to 85°C
- Pressure range: 16 bar at 30° C, 10 bar at 65° C and 8 bar at 85° C
- Size: 28mm
- Type: Full bore ball valve
- Compression complies with BS EN1254-2
- Pressure test under 0.6-0.8 MPa without any leakage
- Suitable for hot and cold water
- Working pressure: 1.6 MPa
- Long stemmed for use with ASHP insulation 19mm - 25mm thick

Part code	Information
BV-28-28-COMP-AGSTEM	Full bore long-stem 28mm compression ball valve

ACCESSORIES



FLEXI FOOT FIX CLAMP

PART NO FF-FIXCLAMP

The fix clamp allows you to secure flexi feet to the floor using anchor bolts. Fixings not supplied



ANTI VIBRATION MOUNTING BOLTS

PART NO AVMB-1

Pack of 4 anti-vibration bolts. Can be used with all DiversiTech International wall brackets



FLOOR BRACKET KIT

PART NO CCTM-FLOOR-BRKT-KIT

Brackets to allow a condensate tray to be mounted on to flexifeet. The ASHP can then be mounted on the brackets.



Part code	Description
CCTM-FLOOR-BRKT-KIT	Stainless Floor Bracket Kit for drip trays - 4 x brackets and fixings
CCTM-FLOOR-BRKT-KIT3	Stainless Floor Bracket Kit for drip trays - 6 x brackets and fixings

ROTARY ISOLATORS

Our insulated 3 and 4 pole rotary enclosed isolators are CE marked and disconnecting the power supply to outdoor air source heat pump units. They are waterproof to IP65 and easy to install and conform to IEC 60947- a lockable off position and interlocking cover which can be removed only position. Earth and neutral terminals included and M20/25 knockouts up



Part code	No of poles	AMPS AC21	AC23 A 240VA	AC23 A 400VA	Cable capacity		Height	Width	Depth
					Solid	Stranded			
IS-3P-20A-S-G	3	20amp	5.5kW	3.7kW	1-16mm ²	0.75-10mm ²	125mm	100mm	120mm
IS-3P-32A-S-G	3	32 amp	11kW	7.5kW	1-16mm ²	0.75-10mm ²	125mm	100mm	120mm
IS-3P-20A-G	3	20amp	5.5kW	3.7kW	1-16mm ²	0.75-10mm ²	175mm	114mm	135mm
IS-3P-32A-G	3	30amp	11kW	7.5kW	1-16mm ²	0.75-10mm ²	175mm	114mm	135mm
IS-3P-40A-G	3	40amp	15kW	11kW	1-16mm ²	0.75-10mm ²	175mm	114mm	135mm
IS-3P-63A-G	3	63amp	22kW	18.5kW	1-16mm ²	0.75-10mm ²	175mm	114mm	135mm
IS-4P-20A-S-G	4	20amp	5.5kW	3.7kW	1-16mm ²	0.75-10mm ²	125mm	100mm	120mm
IS-4P-32A-S-G	4	32 amp	11kW	7.5kW	1-16mm ²	0.75-10mm ²	125mm	100mm	120mm
IS-4P-20A-G	4	20amp	5.5kW	3.7kW	1-16mm ²	0.75-10mm ²	175mm	114mm	135mm
IS-4P-32A-G	4	32amp	11kW	7.5kW	1-16mm ²	0.75-10mm ²	175mm	114mm	135mm
IS-4P-40A-G	4	40amp	15kW	11kW	1-16mm ²	0.75-10mm ²	175mm	114mm	135mm
IS-4P-63A-G	4	63amp	22kW	18.5kW	1-16mm ²	0.75-10mm ²	175mm	114mm	135mm

EXPANDING FOAM SEALANT

A one component closed-cell expanding polyurethane foam sealant that is tack free in 20 minutes. Can be painted to prevent UV damage after 12 hours of drying time. Used to seal around doors, windows, pipes, ducts and vents - in fact, virtually anywhere.



Part code	Description	UOM	Master Qty
FOAM-152760	Gap filler expanding foam - 300ml	Each	12
FOAM-135234	Gap filler expanding foam - 600ml	Each	12

SILICONE SEALANTS

Available in clear or white, DiversiTech silicone sealants are 100% food grade and can be used in applications for continuous use up to 232°C. It is UV and water resistant and has long term flexibility.



Part code	Description	UOM	Master Qty
7-4000	Clear Silicone Sealant - 305ml	Each	12
7-4100	White Silicone Sealant - 305ml	Each	12

DIVERSI-GUM SEALING COMPOUND

Diversi-Gum is a non-hardening, non-corrosive sealing compound that is immediately paintable and has a temperature usage range between -4°C and 49°C. It is ideal for sealing openings through walls from pipework.



Part code	Description	UOM	Master Qty
6-202-1	Diversi-Gum Sealing compound 450g slug	Each	24
6-202-2	Diversi-Gum Sealing compound 900g slug	Each	20

DIVERSI-BOND

Diversi-Bond is a versatile, strong elastic adhesive and sealant for use in bonding and sealing applications in the construction industry. Ideal for air conditioning, plumbing and ventilation sectors where a tough flexible rubber joint and a powerful elastic adhesive bond is required.

- Waterproof and UV-stable
- Expands and contracts with temperature variants (-40°C - +100°C)
- Long-lasting protection against moisture ingress
- Solvent and isocyanate free



Part code	Description	Size	Colour
DIVERSI-BOND	Sealant adhesive for insulation	290ml	Black

INSTALLING



ACCESSORIES

ASHP SOAK-AWAY

This unique pre-bagged geo textile soakaway is used to safely dispose of the condensate from all domestic sized air source heat pumps where drain routing is not available. The volume of condensate created from an air source heat pump up to 16kW can be between 10-15 litres per hour up to 2000 litres per year. This method prevents the condensate from flowing onto paths and driveways, which can freeze and cause a slip hazard.



- Alternative method to condensate removal disposal
- Suitable for all models/brands of air source heat pumps
- Made from pre-bagged geo-textile material to prevent soil ingress
- 32mm inlet
- Capacity - 10-15 litres per hour
- Helps with MIS 3005 compliance and complies with BRE 365

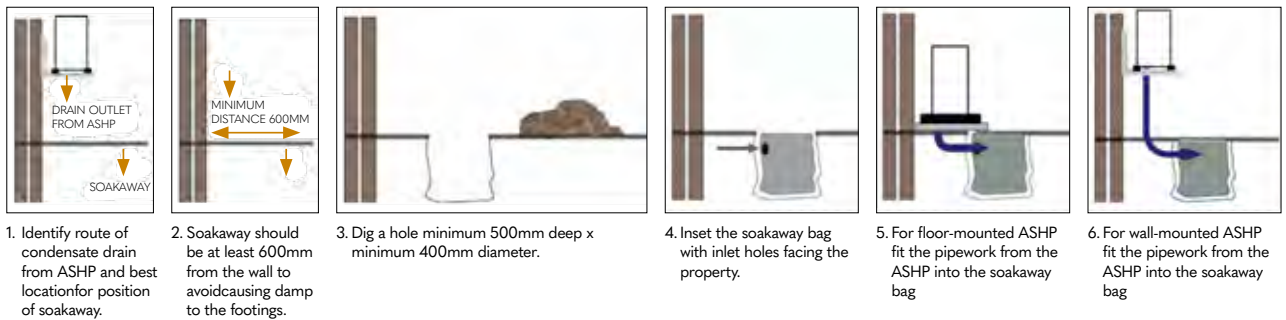

Part code	Description	Inlet	Diameter	Height
ASHP-SOAK	Air source heat pump soakaway - pre bagged geo textile with rubber chippings	32mm	400mm	400mm



AVOID PROBLEMS RESULTING FROM INCORRECT DISPOSAL OF CONDENSATE

FLEXIBLE CONNECTION HOSES

Our flexible hoses meet the requirements of MCS MIS 3005, and help to avoid transmission of vibration through the pipework.

The 28mm hose is sleeved within a stainless steel braid for added protection. All hoses come with 19mm wall insulation which is weatherproof and UV stable.



SOLD IN PAIRS

Part code	Description
FH-300-28-F-ELBOW	Flexible ASHP Hose Pair -300mm x 28mm - 1" FEMALE c/w elbow
FH-300-28-1-1/4ELB	Flexible ASHP Hose Pair -300mm x 28mm - 1 1/4" FEMALE c/w elbow
FH-500-22-F	Flexible ASHP Hose Pair -500mm x 22mm - 1" FEMALE
FH-500-28-F	Flexible ASHP Hose Pair -500mm x 28mm - 1" FEMALE
FH-750-28-F	Flexible ASHP Hose Pair -750mm x 28mm - 1" FEMALE
FH-750-28-M	Flexible ASHP Hose Pair -750mm x 28mm - 1" MALE
FH-750-28-F-ELBOW	Flexible ASHP Hose Pair -750mm x 28mm - 1" FEMALE c/w elbow
FH-750-28-1-1/4F	Flexible ASHP Hose Pair -750mm x 28mm - 1 1/4" FEMALE
FH-750-28-1-1/4M	Flexible ASHP Hose Pair -750mm x 28mm - 1 1/4" MALE



INSULATING

PVC COATED EXTERNAL GRADE INSULATION

External condensate pipework needs to be insulated in a tough PVC coated weather protected covering to avoid UV degradation and animal damage. Boiler installation standards BS 6798-2104 makes specific reference to this grade of insulation. Air source heat pumps and Biomass Boilers tend to be located externally and this hot water pipework needs to be protected and insulated to avoid heat loss, MIS3005 and building regulations advise a certain thickness of insulation to meet heat loss requirements. Our PVC coated range helps installations comply in both boiler condensate and Air source heat pumps installations.



Part code	Description	Length	Diameter	Thickness	ID
FH-I-1000-15	PVC Coated Weather & Waterproof Insulation	1000mm	41mm	13mm	15mm
FH-I-1000-22	PVC Coated Weather & Waterproof Insulation	1000mm	60mm	19mm	22mm
FH-I-1000-28	PVC Coated Weather & Waterproof Insulation	1000mm	66mm	19mm	28mm
FH-I-1000-28-25	PVC Coated Weather & Waterproof Insulation	1000mm	66mm	19mm	28mm
FH-I-1000-28-CLO	PVC Coated Weather & Waterproof Insulation	1000mm	66mm	19mm	28mm
FH-I-1000-35	PVC Coated Weather & Waterproof Insulation	1000mm	73mm	19mm	35mm
INS-TAPE-10-PK	PVC Coated Weather & Waterproof Tape	250mm	50mm	1mm	10 pack

INSULATING



PRE SLIT AND SEAL INSULATION

Our new insulation provides outstanding protection against the elements for external pipework on boiler condensate ASHP and Biomass boilers.

The new design offers a quick and secure 'tape free' installation with its peel and seal joint and self adhesive wrap-over flap. The tough PVC coating is both weatherproof and UV stable.



Part code	Size	Internal diameter
FH-I-1000-22-SLIT	1000mm L x19mm Thickness	22mm ID
FH-I-1000-28-SLIT	1000mm L x19mm Thickness	28mm ID
FH-I-1000-28-25-SLIT	1000mm L x19mm Thickness	28mm ID
FH-I-1000-35-SLIT	1000mm L x19mm Thickness	35mm ID
INS-TAPE-10-PK	PVC Coated Weatherproof Insulation Tape	Length 250mm, Width 50mm x 1mm (pack 10)

THROUGH THE WALL INSULATION KIT

Pipework running through the wall will be affected by cold bridging and heat loss if it's not insulated correctly. MIS 3005 requires external pipework to be properly insulated.

This provides both thermal insulation within the wall and comes complete with an elbow section to cover the external copper pipe connection.



Part code	Size
TW-KIT	Through the Wall Insulation Kit

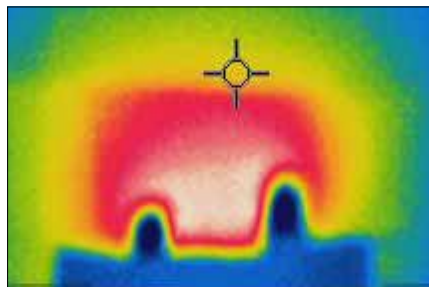

THE CONNECTION OF THE PIPEWORK RUNNING THROUGH THE WALL

THERMAL IMAGES SHOWING JUST HOW MUCH HEAT IS LOST WHEN THESE CONNECTIONS ARE NOT ADEQUATELY INSULATED

ASHP GUARDS

BASIC COLOUR
RAL 7032

DiversiTech International manufacture a range of weather-resistant, steel mesh guards, offering a safe solution to avoid vandalism or accidental damage of your expensive ASHP. The range is ideal for all manufacturers of ASHP units. The unique sliding panel system allows for easy installation, which are secured into place when the front panel is fitted. Back panels are also available to make the guard free standing. For high wall mounted units, we can offer a base panel for full security.



Part code	Size	External dimensions			Internal dimensions			Weight
		Height	Width	Depth	Height	Width	Depth	
CG-750-S	S	950mm	1150mm	750mm	920mm	1120mm	740mm	25kg
CG-750-S-INV	S	950mm	1450mm	750mm	920mm	1420mm	740mm	25.1kg
CG-750-M	M	1150mm	1150mm	750mm	1120mm	1120mm	740mm	32kg
CG-750-L	L	1450mm	1150mm	750mm	1420mm	1120mm	740mm	33kg
CG-750-INV	INV	1150mm	1450mm	750mm	1120mm	1420mm	740mm	33kg

Part code	Size	Height	Width	Depth	Height	Width	Depth	Weight
CG-900L-INV	L	1150mm	1450mm	900mm	1120mm	1420mm	890mm	34kg
CG-900L-SQ	L-SQ	1450mm	1450mm	900mm	1420mm	1370mm	890mm	51kg
CG-900-XXL	XXL	1800mm	1450mm	900mm	1770mm	1370mm	890mm	60kg

Part code	Size	Height	Width	Depth	Height	Width	Depth	Weight
CG-S	S	750mm	1050mm	460mm	720mm	1020mm	450mm	18kg
CG-M	M	1150mm	1150mm	650mm	1120mm	1120mm	640mm	27kg
CG-L	L	1450mm	1150mm	650mm	1420mm	1120mm	640mm	30kg
CG-XL	XL	1800mm	1150mm	650mm	1770mm	1120mm	640mm	40kg
CG-S-BLACK	S	750mm	1050mm	460mm	720mm	1020mm	450mm	18kg
CG-M-BLACK	M	1150mm	1150mm	650mm	1120mm	1120mm	640mm	27kg
CG-L-BLACK	L	1450mm	1150mm	650mm	1420mm	1120mm	640mm	30kg
CG-XL-BLACK	XL	1800mm	1150mm	650mm	1770mm	1120mm	640mm	40kg

WOODEN CONDENSER GUARDS

Made from tanalised, pressure-treated timber. All panels have rounded louvers to optimise air flow. Sized to protect both ASHP and AC units, these guards offer a solution for listed buildings and sites where aesthetics are a consideration. All components are flat-packed for easy transport, and easy-to-install and assemble.



Part code	Description	External dimensions			Internal dimensions		
		Height	Width	Depth	Height	Width	Depth
CG-750S-WOOD	Small Guard	905/960	1275	865	850/890	1050	753
CG-750M-WOOD	Medium Guard	1135/1135	1275	865	1075/1115	1055	753
CG-750M+WOOD	Medium+ Guard	1255/1310	1275	865	1200/1240	1055	753
CG-750L-WOOD	Large Guard	1530/1585	1275	865	1475/1515	1055	753
CG-750LINV-WOOD	Large Inv Guard	1130/1185	1630	865	1075/1115	1405	753
CG-750L+WOOD	Large+ Guard	1600/1655	1275	865	1545/1585	1055	753
CG-750L+INVWOOD	Large+ Inv Guard	1655/1690	1630	865	1580/1620	1405	753

PROTECTING



EXTERNAL TRUNKING

Pipework and insulation running from an air source heat pumps should be protected. Our range of trunking comes in a 140mm width with an ivory or black option and accommodates both the insulated flow and return pipework along with any associated cabling.

- Easy to install
- 140mm wide
- Provides a professional and neat finish
- Made from high grade, UV stable, fade resistant PVC
- Available in Ivory and Black
- Protection from the elements, accidental damage and pest damage



Ivory part code	Description	Size (depth x width)
TR-D-140	140mm Trunking (2000mm Length)	90mm x 140mm
TR-WC-140	140mm Wall Cover	90mm x 140mm
TR-CP-140	140mm Straight Connector	90mm x 140mm
TR-IC-140	140mm 90 Degree Internal Bend	90mm x 140mm
TR-FB-140	90 Degree Flat Bend	90mm x 140mm
TR-EC-140	90 Degree External Bend	90mm x 140mm

Black part code	Description	Size (depth x width)
TR-D-140-B	140mm Trunking (2000mm Length)	90mm x 140mm
TR-WC-140-B	140mm Wall Cover	90mm x 140mm
TR-CP-140-B	140mm Straight Connector	90mm x 140mm
TR-EC-140-B	140mm Straight Connector	90mm x 140mm
TR-IC-140-B	140mm 90 Degree Internal bend / External bend	90mm x 140mm
TR-FB-140-B	90 Degree Flat Bend	90mm x 140mm
TR-EL45-140-B	45 Degree Vertical Bend	90mm x 140mm

AVAILABLE IN



IVORY



BLACK

PROTECTING

EXTERNAL TRUNKING

AVAILABLE IN

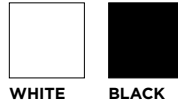

- Made of rigid, shockproof, UV-stabilised fire resistant PVC B
- High-quality (usable from -20°C / -4°F to +60°C / 140°F in a static position)
- The inside fixation rail (SpinFix) allows you to use cable ties to strap and keep the linesets in place - contributing to the duct rigidity

DUCT



Description	Width	Colour	Part code
SpeediDuct trunking (2000mm length)	150mm	Black	TR-D-150-B
SpeediDuct trunking (2000mm length)	150mm	White	TR-D-150-W

CONNECTION PIECE



Description	Width	Colour	Part code
SpeediDuct Connection piece	150mm	Black	TR-CP-150-B
SpeediDuct Connection piece	150mm	White	TR-CP-150-W

FLAT BEND



Description	Width	Colour	Part code
SpeediDuct flat bend	150mm	Black	TR-FB-150-B
SpeediDuct flat bend	150mm	White	TR-FB-150-W

WALL COVER



Description	Width	Colour	Part code
SpeediDuct wall cover	150mm	Black	TR-WC-150-B
SpeediDuct wall cover	150mm	White	TR-WC-150-W

90° EXTERNAL BEND

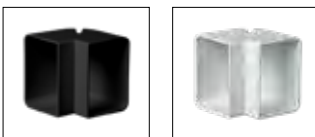

Description	Width	Colour	Part code
SpeediDuct 90° external bend	150mm	Black	TR-EC-150-B
SpeediDuct 90° external bend	150mm	White	TR-EC-150-W

90° INTERNAL BEND



Description	Width	Colour	Part code
SpeediDuct 90° internal bend	150mm	Black	TR-IC-150-B
SpeediDuct 90° internal bend	150mm	White	TR-IC-150-W

MAINTAINING

COIL CLEANING

Heat exchangers can get clogged with dirt and debris. It's essential to keep these clean to maintain optimum efficiency. PRO-HEATPUMP / G@G-HEATPUMP are environmentally friendly cleaners for ASHP heat exchangers. Available ready-mixed or concentrated.



Part code	Description
G2G-Green+	G2G Green 1 Litre pre-mixed Coil Cleaner Spray
Pro-Green-GB	Pro-Green 5 Litre Concentrated Coil Cleaner

BUBBLE-UP LEAK SPRAY

Leak Seek is a leak detection spray designed to locate refrigerant leaks. Suitable for high and low pressure leaks, this formulation is alcohol and solvent free and has long lasting bubbles.



Part code	Description
AER-B-500	500ml Leak Detection Spray

ELECTRONIC LEAK DETECTOR - TIF XP-1A

The TIF XP-1A detects all HFC, HFO and HCFC refrigerants, and will find a leak as small as 3 grams per year. Requires 2 x 'C' Batteries.



Part code	Description
TIF-XP1A	TIF Electronic Leak Detector

A3 KIT

Tube Benders		
1	HIL-1839031	Spring Bender 4 Pack 1/4" - 5/8"
Flaring & Swaging		
2	1838947	Quick Engage Flare & Swage 3/16 To 3/4
Flaring & Swaging		
3	Bosch RG-4.0	Bosch RG 4.0 Refrigerant Recovery Machine 240V A3/A2L
4	RA1550-A3	Robinair 5cfm Vacuum Pump A3 Dual Voltage Spark Proof
5	RA1500-A3	10 Metre Exhaust Kit for RA1550-A3
6	CVG1200	Hilmor Digital Vacuum Gauge
7	Bosch CS-LD-1	Bosch Refrigerant/Hydrocarbon Leak Detector
8	TIF9030E	TIF Refrigerant Scale 100Kg
9	1839106	Digital Dual Readout thermometer
Flaring & Swaging		
11	IMP-572FTY	Vacuum Hose 3/8" x 72"



A2L KIT

Tube Benders		
1	HIL-1839031	Spring Bender 4 Pack 1/4" - 5/8"
Flaring & Swaging		
2	1838947	Quick Engage Flare & Swage 3/16 To 3/4
Flaring & Swaging		
3	Promax RG3000	Promax RG3000 Refrigerant Recovery Machine 240v A2L
4	RA15501-A-E-A2L	Robinair 5cfm Vacuum Pump A2L 240V
5	CVG1200	Hilmor Digital Vacuum Gauge
6	Bosch CS-LD-1	Bosch Refrigerant/Hydrocarbon Leak Detector
7	TIF9030E	TIF Refrigerant Scale 100Kg
8	1839106	Digital Dual Readout thermometer
Flaring & Swaging		
10	IMP-572FTY	Vacuum Hose 3/8" x 72"

NOT ALL INSULATION IS THE SAME!



GREY/SILVER INSULATION
FOR INTERNAL USE ONLY



PAINTED GREY INSULATION
SHORT FIELD LIFE AND
REQUIRES RECOATING
EVERY FEW YEARS



BLACK CLASS 0
WEATHER-PROOF BUT
NOT UV STABLE



BLACK PVC COATED
CLASS 0 WEATHER-PROOF
AND UV STABLE

ARE YOU GETTING 100% OF HEAT

INSULATE PIPEWORK

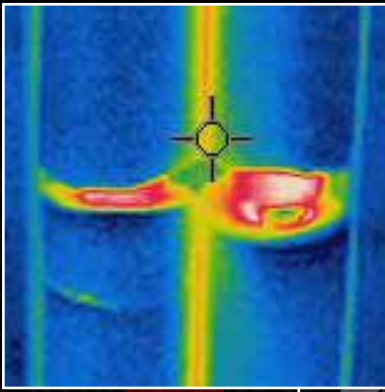

INSULATE CONNECTIONS

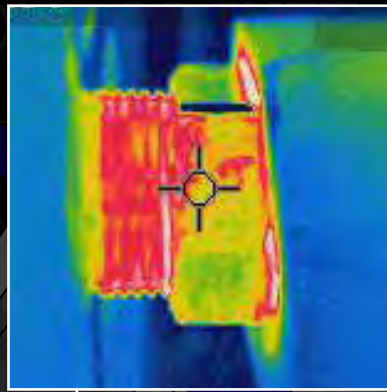

INSULATE THROUGH THE WALL

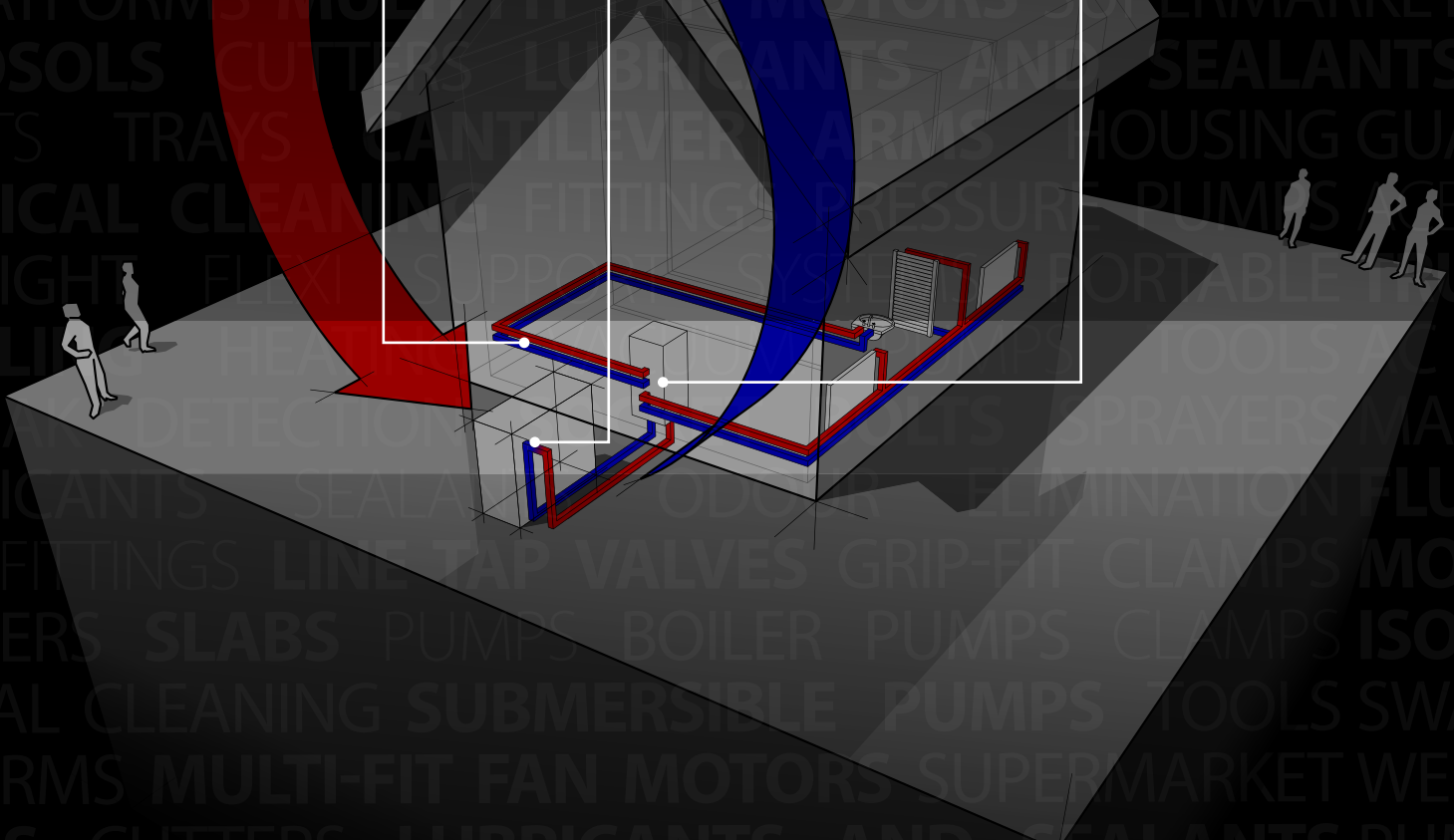
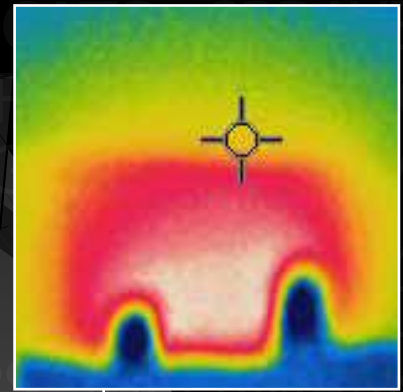

FLEXI SUPPORT

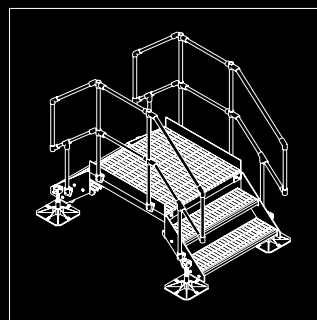
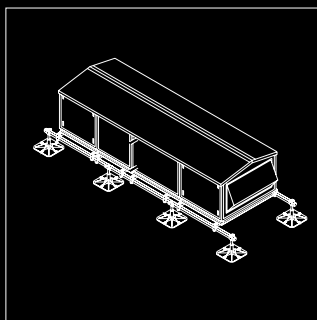
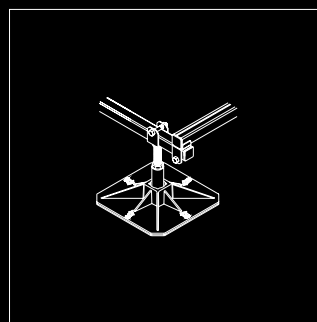
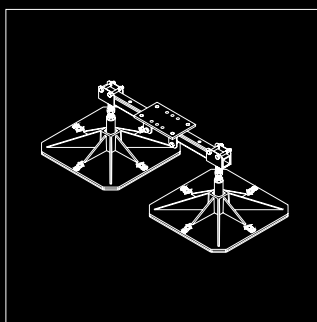

FLEXI BASE & EXTENDER FRAMES

BASE & EXTENDER frames are designed to provide stability and spread loads evenly across flat roof surfaces. Modular frames are ideal for a/c split systems and VRV/ VRF systems.

The galvanised steel frame raises equipment up to 405mm (higher heights available) above the flat roof level, permitting quick and easy access for roof maintenance.



STEP 1.
ASSEMBLE A BASE FRAME

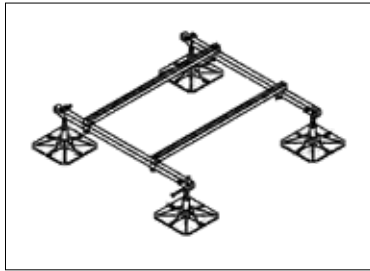

ORDER PH-BF-B

STEP 2.
NEED A BIGGER FRAME? ADD AN
EXTENDER FRAME

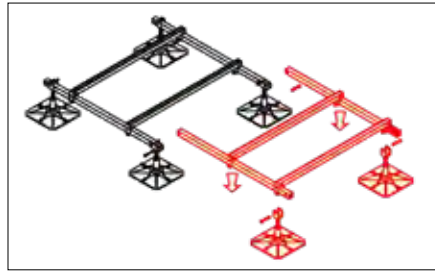

ORDER PH-EF-B

STEP 3.
CONNECT THE BASE AND EXTENDER
FRAMES TOGETHER

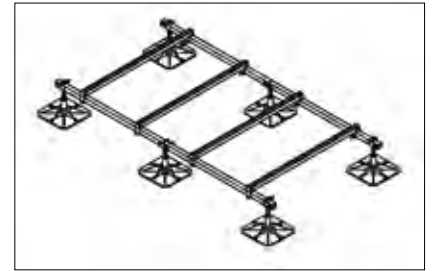

ORDER PH-BF-B & PH-EF-B

Item	Material
FEET	Square - 320mm square UV stabilised - 90% polypropylene and 10% grp
LEGS	"48mm diameter, 3mm galvanised steel tube. M24 galvanised steel height adjust er. 3mm galvanised steel U -clevis"
BOX BEAMS	40mm x 40mm x 2.5mm galvanised box section
CROSS BEAMS	41mm x 41mm x 2.5mm galvanised steel slotted strut
FIXING BOLTS	M12 spun galvanised



Code	Description	Length	Width	Min. Height	Max. Height	"Safe Working Load**"	Weight
PH-BF-B	Flexi Base Frame	1200mm	1200mm	300mm	405mm	500kg	30kg
PH-EF-B	Flexi Extender Frame	1200mm	1200mm	300mm	405mm	500kg	24kg

EVERYDAY - FLEXI H-FRAME KITS

Our H-frame kits offer the installer full flexibility by providing a solution where they can supply their own strut to suit their installation requirements.

The H-frame kits are supplied with a pair of either our 305mm feet, most widely used in the majority of installations, or where heavier more demanding loads are present, then our 500mm foot version kit is available.

All kits are supplied with hot dip galvanised angle brackets together with all the necessary fixings to assist the installer in a low cost, versatile and fast assembly solution on site.

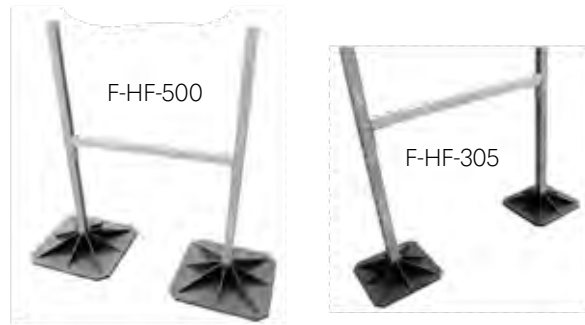

Part code	Description	Foot size	Safe working load*	Weight
F-HF-305	Flexi H-Frame Kit - 2 square block feet with fittings*	305mm x 305mm	105kg	2.8kg
F-HF-500	Flexi H-Frame Kit - 2 square block feet with fittings*	500mm x 500mm	600kg	13kg

Complete strut assembled frameworks, (H-frame kits where the strut is also supplied), are available upon request.

Item	Material
FEET	Square - 305mm and 500mm square UV stabilised - 90% polypropylene and 10% grp
MAT	100% natural rubber, (mat is adhered to the feet)
FIXINGS	M10 ZP sets, spring washers and nuts
ANGLE BRACKETS	Mild steel, hot dipped galvanised BS EN ISO 1461:2009

* NB - the lengths of the strut are not supplied with this kit. ** As the strut is not supplied with the kit, the maximum load is a guide only.

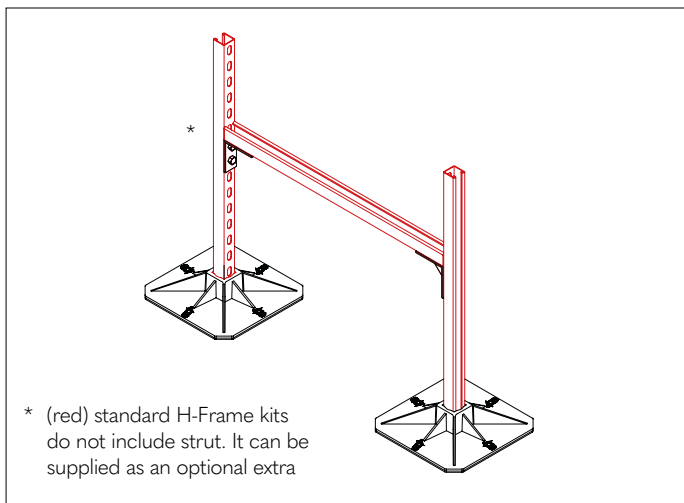

** It is the installer's responsibility to ensure that equipment weights do not exceed the safe working loads quoted and that the roof structure onto which these products are being applied is sufficiently sound to withstand the weight and point loading. If these products are used in contact with a PVC/TPO roof membrane the installer should seek advice from the membrane manufacturer on the possible migration of plasticizers and the effect of this on the roof guarantee. These products should

not be used for any purpose other than that for which they have been designed and the products must not be modified in any way. Pump House accepts no liability for damage caused by the incorrect application or installation of these products..

EVERYDAY - FLEXI FOOT WITH STRUT

Flexi Foot With Strut – These feet can support pipework, cable tray, and can also be used to mount air conditioning units, air source heat pumps and a variety of outdoor equipment.

Solar thermal and solar photovoltaic on flat roof installations can also be accommodated. Made from heavy duty recycled rubber. The 21x41mm galvanised steel strut is supplied bonded to the rubber. Drain slots are molded to the underside of the foot.



Item	Material
RUBBER	Compression moulded using milled, sieve d and graded, recycled rubber bound with high quality adhesive
DENSITY	1.0kg / cm ³
STRUT	41 x 21 x 1.5mm galvanised steel



Part code	Description	Length mm	Width mm	Height mm	Safe Working Load*	Weight
FF-250-S	Flexi Foot With Strut - 250mm	250	185	100	175kg	2.8kg
FF-400-S	Flexi Foot With Strut - 400mm	400	185	100	280kg	4.6kg
FF-600-S	Flexi Foot With Strut - 600mm	600	185	100	420kg	7.6kg
FF-1000-S	Flexi Foot With Strut - 1000mm	1000	185	100	700kg	12.0kg

Part code	Description	Length mm	Width mm	Height mm	Safe Working Load*	Weight
FF-250-S-P-L	Flexi Foot With Strut - 250mm - Low Profile	250	185	50	100kg	1.4kg
FF-400-S-P-L	Flexi Foot With Strut - 400mm - Low Profile	400	185	50	150kg	2.3kg
FF-600-S	Flexi Foot With Strut - 600mm	600	185	100	420kg	7.6kg
FF-1000-S	Flexi Foot With Strut - 1000mm	1000	185	100	700kg	12.0kg

BABY SUMO RUBBER ADJUSTABLE SUPPORT FOOT

These mini adjustable feet are perfect as ground supports for AC and ASHP units. They are made from reprocessing discarded tyres where 70-95% of the rubber can be recovered. These feet are made of a blend of SBR vulcanised UV-stable rubber with internal glass fibre-reinforced polypropylene.



Part code	Description	Height (B)	Width (A)	Depth (C)	Safe working load	Fixing (D)	QTY
SUMO-FT	Mini adjustable foot	160-210mm	160mm	160mm	150kg (per foot)	M10	Pack of 4
SUMO-FT-6	Mini adjustable foot	160-210mm	160mm	160mm	150kg (per foot)	M10	Pack of 6

EVERYDAY - FLEXI FOOT UNIVERSAL

The Flexi Foot Universal has three M10 inserts, offering support for small pipework and runs of cable tray, for air source heat pumps and a variety of outdoor equipment. The installer is free to bolt their own strut of various lengths to suit any installation from 500mm to 3000mm in length. It can also be used to support both solar thermal and solar photovoltaic on flat roof installations.



Part code	Description	Length mm	Width mm	Height mm	Safe Working Load*	Weight
FF-250-UNI	Flexi Foot Universal - 250mm	250	185	100	125kg	2.8kg

Item	Material
RUBBER	Compression moulded using milled, sieved and graded, recycled rubber bound with high quality adhesive
DENSITY	1.0kg / cm ³
INSERTS	M10 (metric course thread) x 20mm zinc plated steel , through inserts
MAX. TORQUE (INSERTS)	15Nm
MAX. LOAD (INSERTS)	25kg

* The maximum load quoted is 25kg per insert and have been tested with a 4:1 safety ratio.

FLEXI FIX CLAMP

The Flexi Fix Clamp is used to add stability particularly with twin fan units. The Fix Clamp can be secured to the floor with anchor bolts.



Part code	Description	Length mm	Width mm	Height mm
FF-FIXCLAMP	Flexi Foot Fix Clamp	240	60	103

FLEXI FIX PACKS

To complement our range of Flexi Feet we have created two versions of fix packs in either spring nut or T bolt. The packs contain bolts, nuts and washers for the installation of a pair of feet for a single condensing unit.



Code	Description
FF-FIX-PACK	Components with spring bolts to secure an outdoor AC unit - for 2 Flexi Feet
FF-FIX-2	Components with T bolts to secure an outdoor AC unit - for 2 Flexi Feet

PROTECTION FLEECE

Geotextile polyester fleece for PVC/TPO field membrane protection. Sold by linear metre. Please specify requirements.



Part code	Description	Density
MPP-12	Protection Fleece - 2000mm x 1000mm	300gsm

FLEXI FOOT VARIATIONS

To complement our range of Flexi Feet we have a number of variations on the standard flexi foot with strut. The foot only options are available in 200, 350 and 500mm with angle pitch variants.



Part code	Description	Length mm	Width mm	Height mm	Safe Working Load**	Weight
PH-FO-200	Flexi Foot - 200mm for vertical strut / M10 thread	200	200	85	100kg	2.3kg
PH-FO-350	Flexi Foot - 350mm for vertical strut	350	350	110	150kg	5.7kg
PH-FO-350-2	Flexi Foot - 350mm for vertical 82x41mm strut	350	350	110	150kg	5.7kg
PH-FO-350-2.5-S	Flexi Foot - 350mm for vertical 2.5 degree	350	350	125	150kg	5.9kg
PH-FO-350-5.0-S	Flexi Foot - 350mm for vertical 5.0 degree	350	350	140	150kg	6.1kg
PH-FO-500	Flexi Foot - 500mm for vertical strut	500	500	110	150kg	10.5kg
PH-FO-500-2	Flexi Foot - 500mm for vertical 82x41mm strut	500	500	110	150kg	10.5kg
PH-FO-500-2.5	Flexi Foot - 500mm for vertical 2.5 degree	500	500	130	150kg	10.7kg
PH-FO-500-5.0	Flexi Foot - 500mm for vertical 5.0 degree	500	500	150	150kg	10.9kg

FLEXI MINI FOOT

Lightweight support that may be used with horizontal or vertical strut to support low level cable tray and other services.

- Accepts 41mm x 41mm strut vertically into core
- Accepts 41mm x 41mm strut horizontally via fixing screw (supplied)
- Foam anti-vibration pad pre-fitted to the base
- Made from UV-stable pvc, strut not supplied



Part code	Description	Length mm	Width mm	Height mm	Safe Working Load**	Weight
F-MF-110	Flexi Foot mini - 110mm	110mm	110mm	60mm	-	-
F-MF-160	Flexi Foot mini - 160mm	160mm	160mm	60mm	50kg	230g

WALKWAY MAT

Walkway mats may be combined to define a safe access path whilst protecting the roof surface.

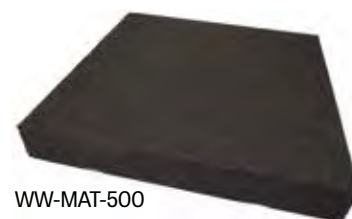

Code	Description	Length mm	Width mm	Height mm	Safe working load*	Weight
PH-WW-MAT-500	Walk Way Mat - 500mm	500	500	45	150kg	14kg
PH-WW-MAT-1000-17	Walk Way Mat - 1000mm	1000	1000	45	600kg	17kg

** It is the installer's responsibility to ensure that equipment weights do not exceed the safe working loads quoted and that the roof structure onto which these products are being applied is sufficiently sound to withstand the weight and point loading. If these products are used in contact with a PVC/TPO roof membrane the installer should seek advice from the membrane manufacturer on the possible migration of plasticizers and the effect of this on the roof guarantee. These products should not be used for any purpose other than that for which they have been designed and the products must not be modified in any way. Pump House accepts no liability for damage caused by the incorrect application or installation of these products.

HEAVY - FLEXI TWIN FRAMES

Frames for large pipes, air handling units, chillers and packaged plant rooms. These robust & versatile free standing modular frames are supplied with fully adjustable leg assemblies in 500mm square polypropylene feet, incorporating anti-vibration rubber mats adhered to the underside. Robust 50 x 50mm box cross bars are 5mm thick to cater for mid-span point loads, resulting in even load dispersal through the framework down to each foot.



The optional mounting plate can be purchased in addition or as an alternative to the adjustment being in the leg assemblies. Therefore a non-adjustable twin is also available.

Application: Suitable for heavier building services such as large air handling units, chillers and packaged plantrooms. An ideal solution when the criteria to target existing roof beams is necessary. The twin frames can be targeted immediately above to assist direct load transfer to existing roof beams below: a common requisite in weaker roof designs.

Item	Material
FEET	Square - 500mm square UV stabilised - 90% polypropylene and 10% grp
MAT	100% natural rubber, (mat is adhered to the feet)
LEGS	48mm dia. 3mm stud steel tube with M24 stud adjuster and 4mm thick U clevis to top
CROSS BARS	50x50x5mm SHS (Square hollow section) with optional mounting plate if required
FINISH	"Hot dip galvanised steelwork BS EN 10219-1: 2006 Galvanising BS EN ISO 1461:2009 Salt Mist Testing : BS EN 60068-2-52-2018"



DOUBLE MOUNTING PLATE
PART CODE - F-TQ-ADJ-D



SINGLE MOUNTING PLATE
PART CODE - F-TQ-ADJ-S

Part code	Description	Length mm	Width mm	Height mm	Weight	Max Load
F-TWIN-320-A	Flexi TWIN (adjustable legs)	1020mm	320mm	250-380mm	14kg	350kg
F-TWIN-500-A	Flexi TWIN (adjustable legs)	1200mm	500mm	250-380mm	30kg	1000kg
F-TQ-ADJ-S	Single Mounting Plate	250mm	150mm	-	3kg	-
F-TQ-ADJ-D	Double Mounting Plate	250mm	150mm	170mm (adjustable)	8kg	-

HEAVY - FLEXI QUAD FRAMES

These robust & versatile free standing modular frames are supplied with fully adjustable leg assemblies and 500 x 500mm polypropylene feet, which incorporates anti-vibration rubber mats adhered to the underside.

Robust 50 x 50mm box end bars and cross bars both being 5mm thick in section, cater for picking up the point load mid span, resulting in even load dispersal through the framework down to the feet. The optional adjuster plate can also be purchased and these are supplied with fixings.



Application: Suitable for heavier building services such as large air handling units, chillers and packaged plantrooms. Quads are particularly useful for managing heavy loads, and as a direct replacement for traditional concrete plinths, as they can be re-positioned to accommodate late design changes

Item	Material
FEET	Square - 500mm square UV stabilised - 90% polypropylene and 10% grp
MAT	100% natural rubber, (mat is adhered to the feet)
LEGS	48mm dia. 3mm stud steel tube with M24 stud adjuster and 4mm thick U clevis to top
END BARS	50x50x5mm SHS (Square hollow section)
CROSS BARS	50x50x5mm SHS (Square hollow section) with optional mounting plate if required
FINISH	"Hot dip galvanised steelwork BS EN 10219-1:2006 Galvanising BS EN ISO 1461:2009. Salt Mist Testing: BS EN 60068 -2-52:2018"



DOUBLE MOUNTING PLATE
PART CODE - F-TQ-ADJ-D



SINGLE MOUNTING PLATE
PART CODE - F-TQ-ADJ-S

Part code	Description	Length mm	Width mm	Height mm	Weight	Max Load
F-QUAD-320-A	Flexi QUAD (adjustable legs)	1061mm	1020mm	305-435mm	60kg	2000kg
F-QUAD-500-A	Flexi QUAD (adjustable legs)	1241mm	1200mm	305-435mm	64kg	2000kg
F-TQ-ADJ-S	Single Mounting Plate	250mm	150mm	-	3kg	-
F-TQ-ADJ-D	Double Mounting Plate	250mm	150mm	170mm (adjustable)	8kg	-

HEAVY - FLEXI MODULAR FRAMES

Modular robust frames for large air handling units.

These robust free standing modular frameworks are supplied with fully adjustable leg assemblies and 500 x 500mm polypropylene feet, incorporating anti-vibration rubber mats adhered to the underside. Robust 50 x 50mm square hollow section end bars are 2.5mm thick and are supplied with either 50 x 50mm, or 100 x 50mm cross bars. With a variety of sizes available for both our end bars and cross bars, a suitable framework can be designed to suit many applications where a strong support is key.



Application: Suitable for heavier building services such as large air handling units, chillers and air cooled condensers. Our unique 'drop on' cross bars offer a faster alternative when erecting the framework compared with some slide on systems.

Item	Material
FEET	Square - 500mm square UV stabilised - 90% polypropylene and 10% grp
MAT	100% natural rubber, (mat is adhered to the feet)
LEGS	48mm dia. 3mm stud steel tube with M24 stud adjuster and 4mm thick U clevis to top
END BARS	50x50x2.5mm SHS (square hollow section)
CROSS BARS	50x50x3mm SHS & 100x50x3mm (square/ rectangular hollow section)
FINISH	Hot dip galvanised steelwork BS EN 10219-1:2006 Galvanising BS EN ISO 1461:2009. Salt Mist Testing: BS EN 60068 -2-52:2018



Part code	SHS Section	1000mm	1500mm	2000mm	2500mm	3000mm	3500mm
END BAR	50x50x2.5	PHF-005A	PHF-005B	PHF-005C	-	PHF-005D	-
CROSS BAR	50X50X3.0	-	PHF-016	-	-	-	-
CROSS BAR	100X50X3.2	-	-	PHF016A	PHF-016B	PHF-016C	PHF-016D
F-TQ-ADJ-D	Double Mounting Plate	250mm	150mm	170mm (adjustable)	8kg	-	-

HEAVY - FLEXI CUSTOM FRAMES

Custom robust frameworks for the support of complex and heavy building services.

These custom solutions are frequently manufactured from 100 x 50mm parallel flange channel and/or 100x 100mm HEB (European Beam) and supported off fully adjustable leg assemblies utilising our larger 500 x 500mm polypropylene feet, incorporating anti-vibration rubber mats adhered to the underside. However larger steel sections are available dependant on project requirement and/or mass or size of the services being supported. All frameworks are hot dip galvanised. We will provide an AutoCAD drawing proposal together with load calculations prior to manufacture.



Application: Suitable for heavier chillers, packaged plantrooms, or complex shaped building services, typically air handling units. Steelwork comes with all necessary fixings and the correct amount of leg assemblies/feet. These are manufactured in the UK offering a very fast lead time.

Item	Material
FEET	Square - 500mm square UV stabilised - 90% polypropylene and 10% grp
MAT	100% natural rubber, (mat is adhered to the feet)
LEGS	Custom manufactured to suit most heights and welded frames. Supplied with M24 adjuster stud for levelling
FRAME	Dependant on load/span
FINISH	Hot dip galvanised steelwork BS EN 10219-1:2006 Galvanising BS EN ISO 1461:2009. Salt Mist Testing: BS EN 60068 -2-52:2018



Information required	AHU Requirements	Chiller Requirements	Packaged Plantroom Requirements
	1	Sectional quantity	AVM quantity & point loads
2	Sectional dimensions	AVM dimensional locations	Sectional dimensions
3	Sectional weight	Total weight (operating mass)	Total weight (operating mass)
4	Overall dimensions & weight	Overall dimensions	Overall dimensions

ACCESS - FLEXI STEP-OVERS & HOP-OVERS

Safe access solutions designed and manufactured to current British Standards.

With the introduction of The Work at Height Regulations back in 2005, the regulations apply to all work at height where there is a risk of a fall liable to cause personal injury. This regulation places duty on employees, the self employed and any person that controls the work of others, e.g. facility managers, building owners/end users etc. Flexi access solutions are designed to current British Standards; we offer full working drawings, site surveys and all our access range is manufactured in the UK. GRP options are also available upon request. So whether it's a cat ladder, companion way ladder, stairs, ramps, walkways or a combination of all these, flexi access will provide you and your workforce with a safe access solution. We can also offer a custom design service to suit your needs.



Application: Step-Overs to bridge ducts, pipes and electrical containment; custom solutions to access maintenance doors to AHU's chillers or other rooftop services, ramped access solutions where wheel barrow / sack barrows are used and straight forward elevated access solutions. Cat ladders and companion way ladder also available.

Item	Material
FEET	Square - 320mm square UV stabilised - 100% polypropylene
MAT	320mm feet only - 100% natural rubber, (mat is adhered to the feet)
LEGS	Step-Overs; 48mm dia. 3mm stud steel tube with M24 stud adjuster and 3mm thick U clevis to top
LEGS	Hop-Overs; 40x40x2mm SHS (Square hollow section)
HAND RAILS	33.7mm diameter mild steel
TREADS / FLOORING	25x3mm open grid flooring. (41/100 bearing bars) and designed to 7.5 Kn/M ² Loading BS4592 part 1
FINISH	Hot dip galvanised steelwork BS EN 10219-1:2006 Galvanising BS EN ISO 1461:2009. Salt Mist Testing: BS EN 60068 -2-52:2018



Part code	Description	Thread QTY	Landing size 99	Clearance height mm	Foot size
F-SO-2	Flexi Step Over 2 up / 2 down	2 up / 2 down	1000mm x 1000mm	560mm	320mm x 320mm
F-SO-3	Flexi Step Over 3 up / 3 down	3 up / 3 down	1000mm x 1000mm	780mm	320mm x 320mm
F-SO-4	Flexi Step Over 4 up / 4 down	4 up / 4 down	1000mm x 1000mm	1000mm	320mm x 320mm
F-HO-600	Flexi Hop Over - 600mm	-	1000mm x 600mm	180mm	320mm x 320mm
F-HO-1000	Flexi Hop Over - 1000mm	-	1000mm x 1000mm	180mm	320mm x 320mm
F-HO-HR	Flexi Hand Rail for Hop Over	-	-	-	-

ACCESS - FLEXI CUSTOM PLATFORMS & WALKWAYS

A tailored solution to fit around existing rooftop building services.

Flexi custom platforms and walkways are designed to provide solutions for maintenance and fire exit access. We can visit sites and carry out a thorough survey from which we generate AutoCAD drawings. These will be forwarded for approval to the project team prior to manufacture. They are manufactured from mild steel with a hot dip galvanised finish. Alternatively we can offer aluminium or GRP solutions upon request.

Designed to comply with British Standards, these versatile and easy to assemble solutions are supplied with M24 adjustable legs, (to cater for the roof fall), and supported by our 320mm square feet

Application: Generally positioned on flat roofs providing access to rooftop building services and fire exit access solutions.

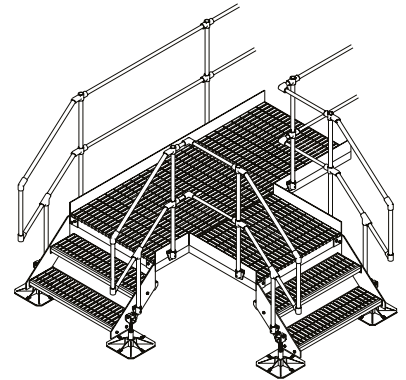

Item	Material
FEET	Square - 320mm square UV stabilised - 100% polypropylene
MAT	320mm feet only - 100% natural rubber, (mat is adhered to the feet)
LEGS	Step-Overs; 48mm dia. 3mm stud steel tube with M24 stud adjuster and 3mm thick U clevis to top
LEGS	Hop-Overs; 40x40x2mm SHS (Square hollow section)
HAND RAILS	33.7mm diameter. Kee Klamp (or similar) c/w interchangeable fittings
TREADS / FLOORING	25x3mm open grid flooring. (41/100 bearing bars) and designed to 7.5Kn/M ² Loading BS4592 part 1
FINISH	Hot dip galvanised steelwork BS EN 10219-1:2006 Galvanising BS EN ISO 1461:2009. Salt Mist Testing: BS EN 60068 -2-52:2018



DIVERSITECH INTERNATIONAL SUPPLY ACCESS SOLUTIONS THAT UTILISE STAIRS, COMPANION WAY LADDERS OR CAT LADDERS, OR A COMBINATION OF ALL OF THESE. RAMPED ACCESS SOLUTIONS ARE ALSO AVAILABLE UPON REQUEST. MANUFACTURED TO CURRENT BRITISH STANDARDS, PUMP HOUSE SUPPLY THE SOLUTIONS FLAT PACKED WITH ALL NECESSARY FIXINGS FOR QUICK ASSEMBLY ON SITE BY OTHERS. WE OFFER AN EFFICIENT MANUFACTURING AND GALVANISING PROCESS AND CAN SUPPLY GOODS TO SITE USUALLY WITHIN 10-15 WORKING DAYS.

FIXINGS

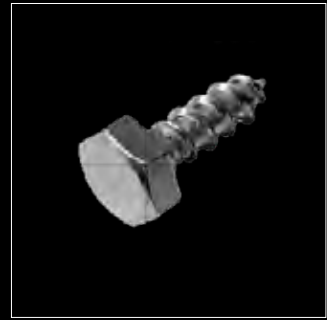
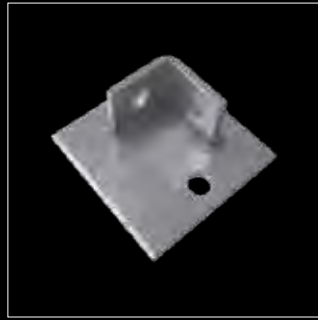
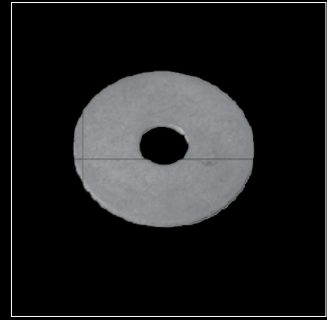

SLOTTED CHANNEL AND ACCESSORIES



SLOTTED CHANNEL

Part code 3m	Part code 6m	Description
X-CH4121-I.5-3M	X-CH4121-I.5-6M	Slotted Channel - 41mm x 21mm x 1.5mm
X-CH4121-2.5-3M	X-CH4121-2.5-6M	Slotted Channel - 41mm x 21mm x 2.5mm
X-CH4141-I.5-3M	X-CH4141-I.5-6M	Slotted Channel - 41mm x 41mm x 1.5mm
X-CH4141-2.5-3M	X-CH4141-2.5-6M	Slotted Channel - 41mm x 41mm x 2.5mm
X-CH4182-2.5-3M	X-CH4182-2.5-6M	Slotted Channel - 41mm x 82mm x 2.5mm

X-CH4121-L.5



BEAM G CLAMP

Part code M6	Part code M8	Part code M10	Part code M12	Description
X-BGC-M6	X-BGC-M8	X-BGC-M10	X-BGC-M12	Beam G Clamp

X-BGC-M8

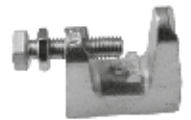

CHANNEL CLAMP

Part code Type 1	Part code Type 2	Part code Type 3	Part code Type 4	Part code Type 5	Part code Type 6	Part code Type 8	Description
X-CBC-1	X-CBC-2	X-CBC-3	X-CBC-4	X-CBC-5	X-CBC-6	X-CBC-8	Channel Clamp

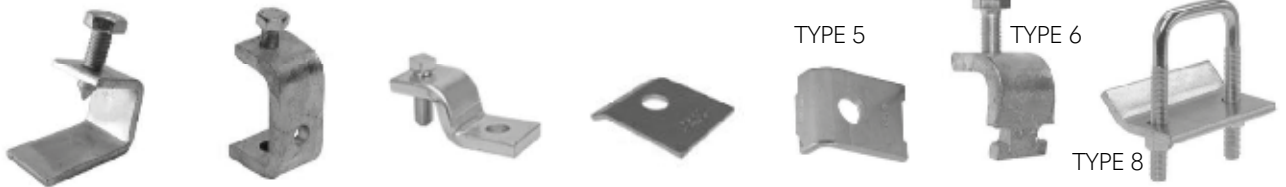

OTHERS

Part code 3m	Description
X-BP810	Back Plate - MB/ MI 0
X-CB90-1HI H	90 Degree Bracket - 1 Hole/1 Hole
X-CB90-1H2H	90 Degree Bracket - 1 Hole/ 2 Hole
X-CB90-2H2H	90 Degree Bracket - 2 Hole/ 2 Hole
X-CH-4-IS	Channel 4 Way Intersection
X-CH-A	Channel Offset - 45 Degree
X-CHBC-3M	Channel Black Capping - 3 metres
X-CHBPIW-4141	Channel Base Plate - One Way - 41mm x 41mm
X-CHBP2W-4141	Channel Base Plate - Two Way - 41mm x 41mm
X-CH-IA-45	Channel Internal Angle - 45 Degree
X-CH-IA-45135	Channel Internal Angle - 45 Degree 135

X-CH-IA-45

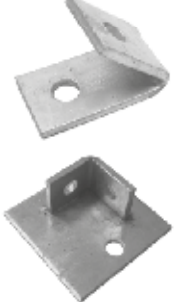

X-CHBP2W-4141

CHANNEL WING FITTING

Part code Type 1	Part code Type 2	Part code Type 3	Part code Type 4	Description
X-CHWF-1	X-CHWF-2	X-CHWF-3	X-CHWF-4	Channel WING FITTING



CHANNEL U BRACKETS

Part code	Description
X-CBU-4121	Channel U bracket - 41mm x 21mm
X-CBU-4141	Channel U bracket - 41mm x 41mm
X-CBU-4162	Channel U bracket - 41mm x 62mm

X-CBU-4121



CHANNEL Z BRACKETS

Part code	Description
X-CHZB-4121	Channel Z bracket - 41mm x 21mm
X-CHZB-4141	Channel Z bracket - 41mm x 41mm

X-CHZB-4121



WINDOW BRACKETS

Part code	Description
X-CWB-4121	Window bracket - 41mm x 21mm
X-CWB-4141	Window bracket - 41mm x 41mm
X-CWB-4182	Window bracket - 41mm x 82mm

X-CWB-4121



FLAT PLATES

Part code 2-hole	Part code 3-hole	Part code 4-hole	Part code 5-hole	Description
X-FP2H	X-FP3H	X-FP4H	X-FP5H	Flat plate

X-FP4H



OTHER PLATES

Part code	Description
X-FP3H-90	Flat plate - 3-hole - 90 degree
X-TBR4H	T bracket - 4-hole
X-TBR4H-90	T bracket - 4-hole - 90 degree

X-TBR4H



PURLING CLIPS

Part code	Description	Quantity
X-PC	Purling clip Z10 beam clamp	Pack of 100
X-PC-M10	Purling clip - pull on - M10	Pack of 100
X-PC-M8	Purling clip - pull on - M8	Pack of 100

X-PC

X-PC-M8



CHANNEL 4-HOLE INTERNAL/EXTERNAL CONNECTORS

Part code	Description
X-CEC4H-4121	Channel 4-hole external connector - 41mm x 21mm
X-CEC4H-4141	Channel 4-hole external connector - 41mm x 41mm
X-CIC4H-4121	Channel 4-hole internal connector - 41mm x 21mm
X-CIC4H-4141	Channel 4-hole internal connector - 41mm x 41mm

X-CEC4H-4121



X-CIC4H-4121

PLASTIC END CAPS

Part code black	Part code white	Description	Quantity
X-CHCB-4121	X-CHCW-4121	Plastic end caps - 41 mm x 21 mm	Box of 100
X-CHCB-4141	X-CHCW-4141	Plastic end caps - 41 mm x 41 mm	Box of 100
X-CHCB-4121 B6	X-CHCW-4121B6	Plastic end caps - 41 mm x 21 mm	Bag of 6
X-CHCB-4141B6	X-CHCW-4141B6	Plastic end caps - 41 mm x 41 mm	Bag of 6

X-CHCW-4121



X-CHCB-4121

THREADED RODS

Part code M6	Part code M8	Part code M10	Part code M12	Description
X-TR-M6-3M	X-TR-M8-3M	X-TR-M10-3M	X-TR-M12-3M	Threaded rod - 3m length

X-TR-M8-3M



STUDDING CAPS

Part code M6	Part code M8	Part code M10	Part code M12	Description	Quantity
X-SCA-M6	X-SCA-M8	X-SCA-M10	X-SCA-M12	Studding caps	Box of 100
X-SCA-M6-B30	X-SCA-M8-B30	X-SCA-M10-B30	X-SCA-M12-B30	Studding caps	Bag of 30

X-SCA-M8



CABLE TRAY

Part code	Description
X-CTMD-PG-50-3M	Cable Tray - Medium Duty Pre Galv. - 50mm x 3 metres
X-CTMD-PG-75-3M	Cable Tray - Medium Duty Pre Galv. - 75mm x 3 metres
X-CTMD-PG-100-3M	Cable Tray - Medium Duty Pre Galv. - 100mm x 3 metres
X-CTMD-PG-I 50-3M	Cable Tray - Medium Duty Pre Galv. - 150mm x 3 metres
X-CTMD-PG-225-3M	Cable Tray - Medium Duty Pre Galv. - 225mm x 3 metres
X-CTMD-PG-300-3M	Cable Tray - Medium Duty Pre Galv. - 300mm x 3 metres
X-CTMD-PG-450-3M	Cable Tray - Medium Duty Pre Galv. - 450mm x 3 metres
X-CTMD-PG-600-3M	Cable Tray - Medium Duty Pre Galv. - 600mm x 3 metres



CABLE TRAY FLAT BENDS

Part code 90°	Part code 45°	Description
X-CTMD-B-50	X-CTMD-FB-50	Cable Tray Flat Bend - 50mm
X-CTMD-B-75	X-CTMD-FB-75	Cable Tray Flat Bend - 75mm
X-CTMD-B-100	X-CTMD-FB-100	Cable Tray Flat Bend - 100mm
X-CTMD-B-150	X-CTMD-FB-150	Cable Tray Flat Bend - 150mm
X-CTMD-B-225	X-CTMD-FB-225	Cable Tray Flat Bend - 225mm
X-CTMD-B-300	X-CTMD-FB-300	Cable Tray Flat Bend - 300mm
X-CTMD-B-450	X-CTMD-FB-450	Cable Tray Flat Bend - 450mm

X-CTMD-FB-150



CABLE TRAY TEES

Part code	Description
X-CTMD-TP-75	Cable Tray Tee - 75mm
X-CTMD-TP-100	Cable Tray Tee - 100mm
X-CTMD-TP-150	Cable Tray Tee - 150mm
X-CTMD-TP-225	Cable Tray Tee - 225mm
X-CTMD-TP-300	Cable Tray Tee - 300mm
X-CTMD-TP-450	Cable Tray Tee - 450mm

X-CTMD-TP-150



Other cable tray accessories are available upon request and come in light, heavy and hot-dipped galvanised versions.

CABLE TRAY INTERSECTION

Part code	Description
X-CTMD-IS-75	Cable Tray Intersection - 75mm
X-CTMD-IS-100	Cable Tray Intersection - 100mm
X-CTMD-IS-150	Cable Tray Intersection - 150mm
X-CTMD-IS-225	Cable Tray Intersection - 225mm
X-CTMD-IS-300	Cable Tray Intersection - 300mm
X-CTMD-IS-450	Cable Tray Intersection - 450mm

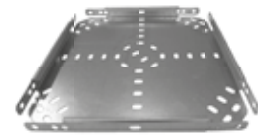

X-CTMD-IS-300

medium and heavy duty versions available

CABLE TRAY REDUCER

Part code	Description
X-CTMD-R-150100	Cable Tray Reducer - 150mm x 100mm
X-CTMD-R-225150	Cable Tray Reducer - 225mm x 150mm
X-CTMD-R-300150	Cable Tray Reducer - 300mm x 150mm
X-CTMD-R-300225	Cable Tray Reducer - 300mm x 225mm
X-CTMD-R-450300	Cable Tray Reducer - 450mm x 300mm
X-CTMD-R-600450	Cable Tray Reducer - 600mm x 450mm



X-CTMD-R-300225

medium and heavy duty versions available

CABLE TRAY HANGER

Part code	Description
X-CTH-PG-50	Cable Tray Hanger - Pre-Galv. - 50mm
X-CTH-PG-75	Cable Tray Hanger - Pre-Galv. - 75mm
X-CTH-PG-100	Cable Tray Hanger - Pre-Galv. - 100mm
X-CTH-PG-150	Cable Tray Hanger - Pre-Galv. - 150mm
X-CTH-PG-225	Cable Tray Hanger - Pre-Galv. - 225mm
X-CTH-PG-300	Cable Tray Hanger - Pre-Galv. - 300mm



X-CTH-PG-100

CABLE TRAY STAND OFF BRACKET

Part code	Description
X-CTMD-SOB-75	Cable Tray Stand Off Bracket - Medium Duty - 75mm
X-CTMD-SOB-100	Cable Tray Stand Off Bracket - Medium Duty - 100mm
X-CTMD-SOB-150	Cable Tray Stand Off Bracket - Medium Duty - 150mm
X-CTMD-SOB-225	Cable Tray Stand Off Bracket - Medium Duty - 225mm
X-CTMD-SOB-300	Cable Tray Stand Off Bracket - Medium Duty - 300mm
X-CTMD-SOB-450	Cable Tray Stand Off Bracket - Medium Duty - 450mm



X-CTMD-SOB-150

Hot-dip galvanised versions available.

CABLE TRAY ACCESSORIES

Part code	Description
X-CTCHD-PG	Cable Tray Coupler - medium duty



BASKET TRAY AND ACCESSORIES



BASKET TRAY

Part code	Description
X-BT-60	Basket Tray - 60mm x 60mm x 3m
X-BT-100	Basket Tray - 100mm x 60mm x 3m
X-BT-150	Basket Tray - 150mm x 60mm x 3m
X-BT-200	Basket Tray - 200mm x 60mm x 3m
X-BT-300	Basket Tray - 300mm x 60mm x 3m
X-BT-400	Basket Tray - 400mm x 60mm x 3m
X-BT-450	Basket Tray - 450mm x 60mm x 3m
X-BT-500	Basket Tray - 500mm x 60mm x 3m
X-BT-600	Basket Tray - 600mm x 60mm x 3m

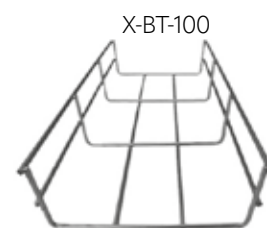

BASKET TRAY QUIK CONNECT

Part code	Description
X-BTM-100	Basket Tray Quik Connect - 100 x 60 x 3mm
X-BTM-150	Basket Tray Quik Connect - 150 x 60 x 3mm
X-BTM-200	Basket Tray Quik Connect - 200 x 60 x 3mm
X-BTM-300	Basket Tray Quik Connect - 300 x 60 x 3mm

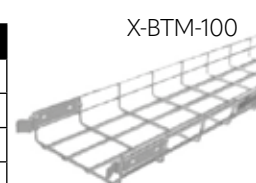

BASKET TRAY WALL SUPPORT BRACKET

Part code	Description
X-BTWB-150	Basket tray wall support bracket - 150mm
X-BTWB-200	Basket tray wall support bracket - 200mm
X-BTWB-300	Basket tray wall support bracket - 300mm
X-BTWB-400	Basket tray wall support bracket - 400mm



BASKET TRAY CEILING BRACKET

Part code	Description
X-BTCB-150	Basket tray ceiling bracket - 150mm
X-BTCB-200	Basket tray ceiling bracket - 200mm
X-BTCB-300	Basket tray ceiling bracket - 300mm



BASKET TRAY ACCESSORIES

Part code	Description
X-BTC	Basket tray couplers - pair
X-BT-CH	Basket tray central support hangers - pair
X-BT-HDC	Basket tray hold down clamp
X-BTJ	Basket tray jointing kit - 4 part kit
X-BT-SH	Basket tray suspension hanger
X-BT-PC	Basket clamping piece - pack of 50
X-BT-FC	Basket corner connector

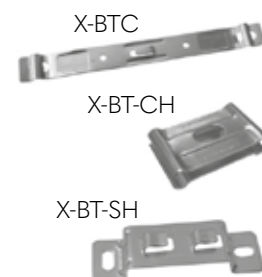

PENNY WASHERS



Part code M6	Part code M8	Part code M10	Part code M12	Description	Quantity
X-WA6-25-B25	X-WAS-25-B25	X-WA10-25-B25	X-WA12-25-B25	Penny Washer 25mm	Bag of 25
X-WA6-25-B100	X-WAS-25-B100	X-WA10-25-B100	X-WA12-25-B100	Penny Washer 25mm	Box of 100
X-WA6-30-B100	X-WAB-30-B100	X-WA10-30-B100	X-WA12-30-B100	Penny Washer 30mm	Box of 100
X-WA6-40-B100	X-WAB-40-B100	X-WA10-40-B100	X-WA12-40-B100	Penny Washer 40mm	Box of 100

FLAT / FORM A WASHERS



Part code M6	Part code M8	Part code M10	Part code M12	Description	Quantity
X-WA-M6-B100	X-WA-M8-B100	X-WA-M10-B100	X-WA-M12-B100	Flat / form A washer	Box of 100

SHAKE PROOF WASHERS



Part code M6	Part code M8	Part code M10	Part code M12	Description	Quantity
X-SPW-M6-B100	X-SPW-M8-B100	X-SPW-M10-B100	X-SPW-M12-B100	Shake proof washer	Box of 100

SQUARE PLATE WASHERS



Part code M6	Part code M8	Part code M10	Part code M12	Description	Quantity
X-SQPW-M6-B6	X-SQPW-M8-B6	X-SQPW-M10-B6	X-SQPW-M12-B6	Square plate washer	Bag of 6
X-SQPW-M6-B100	X-SQPW-M8-B100	X-SQPW-M10-B100	X-SQPW-M12-B100	Square plate washer	Box of 100



NUTS



X-CNLS-MB



X-CNSS-MB



X-CN-MB



X-HN-MB



X-WN-MB



X-RBN-M6-16

LONG SPRING CHANNEL NUTS

Part code M6	Part code M8	Part code M10	Part code M12	Description	Quantity
X-CNLS-M6-B6	X-CNLS-M8-B6	X-CNLS-M10-B6	X-CNLS-M12-B6	Long spring channel nut	Bag of 6
X-CNLS-M6-B100	X-CNLS-M8-B100	X-CNLS-M10-B100	X-CNLS-M12-B100	Long spring channel nut	Box of 100

SHORT SPRING CHANNEL NUTS

Part code M6	Part code M8	Part code M10	Part code M12	Description	Quantity
X-CNSS-M6-B6	X-CNSS-M8-B6	X-CNSS-M10-B6	X-CNSS-M12-B6	Long spring channel nut	Bag of 6
X-CNSS-M6-B100	X-CNSS-M8-B100	X-CNSS-M10-B100	X-CNSS-M12-B100	Long spring channel nut	Box of 100

PLAIN CHANNEL NUTS

Part code M6	Part code M8	Part code M10	Part code M12	Description	Quantity
X-CN-M6-B8	X-CN-M8-B8	X-CN-M10-B8	X-CN-M12-B8	Plain channel nut	Bag of 8
X-CN-M6-B100	X-CN-M8-B100	X-CN-M10-B100	X-CN-M12-B100	Plain channel nut	Box of 100

HEXAGONAL NUTS AND COVER

Part code M6	Part code M8	Part code M10	Part code M12	Description	Quantity
X-HN-M6-B25	X-HN-M8-B25	X-HN-M10-B25	X-HN-M12-B25	Hexagonal nut	Bag of 25
X-HN-M6-B100	X-HN-M8-B100	X-HN-M10-B100	X-HN-M12-B100	Hexagonal nut	Box of 100
	X-HNC-M8-B100	X-HNC-M10-B100		Hexagonal nut cover	Bag of 10

WEDGE NUTS

Part code M6	Part code M8	Part code M10	Part code M12	Description	Quantity
X-WN-M6-B100	X-WN-M8-B100	X-WN-M10-B100	X-WN-M12-B100	Wedge nuts	Box of 100

ROOFING NUTS AND BOLTS

Part code M6-12mm	Part code M8-16mm	Part code M10-20mm	Description	Quantity
X-RBN-M6-12-B20	X-RBN-M8-16-B20	X-RBN-M10-20-B20	Roofing nut and bolt	Bag of 20
X-RBN-M6-12-B100	X-RBN-M8-16-B100	X-RBN-M10-20-B100	Roofing nut and bolt	Box of 100

SCREWS



INSTALL+

X-WPB-7MM

X-WPR-SMM

X-SSS-30

X-CS-M1050

X-TFS-1-1/2

X-TEKS.5-25

X-PBS

X-SCON-MLO

HEX SETS

Part code M6	Part code M8	Part code M10	Part code M12	Description	Quantity
			X-S512-25-B10	Hex Set 25mm	Bag of 10
			X-S512-25-B100	Hex Set 25mm	Box of 100
X-SS6-30-B10	X-SSB-30-B10	X-SS10-30-B10	X-S512-30-B10	Hex Set 30mm	Bag of 10
X-SS6-30-B100	X-SSB-30-B100	X-SS10-30-B100	X-S512-30-B100	Hex Set 30mm	Box of 100
		X-SS10-35-B10		Hex Set 35mm	Bag of 10
		X-SS10-35-B100		Hex Set 35mm	Box of 100
	X-SSB-40-B10		X-SS12-40-B10	Hex Set 40mm	Bag of 10
	X-SSB-40-B100	X-SS10-40-B100	X-SS12-40-B100	Hex Set 40mm	Box of 100
	X-SSB-50-B10	X-SS10-50-B10		Hex Set 50mm	Bag of 10
	X-SSB-50-B100	X-SS10-50-B100		Hex Set 50mm	Box of 100

COACH SCREWS

Part code M8	Part code M10	Description	Quantity
X-CS-M830-B5	X-CS-M1030-B5	Coach screw 30mm	Bag of 5
X-CS-M830-B100	X-CS-M1030-B100	Coach screw 30mm	Box of 100
X-CS-M850-B5	X-CS-M1050-B5	Coach screw 50mm	Bag of 5
X-CS-M850-B100	X-CS-M1050-B100	Coach screw 50mm	Box of 100

TWIN FAST SCREWS

Part code 1"	Part code 1-1/2"	Part code 2"	Part code 2-1/2"	Description	Quantity
X-TF8-1	X-TF8-1-1/2	X-TF8-2		Twin fast screw size 8	Box of 200
X-TF10-1	X-TF10-1-1/2	X-TF10-2	X-TF10-2-1/2	Twin fast screw size 10	Box of 200

TEK SCREWS

Part code	Description	Quantity
X-TEK5.5-25-B100	TEK Screw 5.5 x 25mm	Box of 100
X-TEK5.5-38-B100	TEK Screw 5.5 x 38mm	Box of 100
X-TEK-MAGBIT	5/16 magentic socket adaptor	

PLASTER BOARD SCREWS

Part code	Description	Quantity
X-PBS	Plaster board screw 15mm	Box of 100

STUD CONNECTORS

Part code M8	Part code M10	Description	Quantity
X-SCON-M8-B4	X-SCON-M10-B4	Stud connector	Bag of 4
X-SCON-M8-B100	X-SCON-M10-B100	Stud connector	Box of 100

WALL PLUGS

Part code	Description	Quantity
X-WPR-5MM	Wall plug 5mm - red	Box of 100
X-WPB-7MM	Wall plug 7mm - brown	Box of 100
X-WPG-8/10MM	Wall plug 8/10mm - grey	Box of 25

BOLTS



ANCHOR BOLTS

Part code	Description	Quantity
X-AB-8/10-100-B4	Anchor Bolt 8mm 0-100	Bag of 4
X-AB-MI 0-B100	Anchor Bolt 8mm 0-100	Box of 100
X-AB-MI 0-60-B4	Anchor Bolt 8mm 0-60	Bag of 4
X-AB-MI 0-60-B100	Anchor Bolt 8mm 0-60	Box of 100



LOOSE BOLT SHIELD ANCHOR

Part code	Description	Quantity
X-LBSA-0810L	Loose Bolt Shield Anchor - 0810L	Box of 50
X-LBSA-1010L	Loose Bolt Shield Anchor -1010L	Box of 50
X-LBSA-1025L	Loose Bolt Shield Anchor -1025L	Box of 50



EYE BOLT

Part code	Description	Quantity
X-EB-MB-B25	Eye Bolt - MB x 80mm	Box of 25
X-EB-MI 0-B10	Eye Bolt - MI 0x 80mm	Box of 10



SOCKET BOLTS

Screw anchor TSM 6x35 and 6x55 by M8/M10 (countersunk head with metric internal thread), for fastening pipelines, ceiling brackets, ventilation ducts and timber substructures.

Part code	Description	Quantity
X-SB810-B4	Socket Bolt MB-MI 0	Box of 50
X-SBB10-B100	Socket Bolt MB-MI 0	Box of 50
X-SBL2810-B100	Socket Bolt Loose M8-MI 0 (2 Piece)	Box of 50
X-SBL810-B4	Socket Bolt Loose MB-MI 0 (3 Piece)	Box of 50
X-SBL810-B100	Socket Bolt Loose MB-MI 0 (3 Piece)	Box of 50

Part code	Description	Quantity
X-SBL-810-35-B50	Socket bolt loose M8-M10 (3 piece) 35mm	Box of 50
X-SBL-810-55-B50	Socket bolt loose M8-M10 (3 piece) 55mm	Box of 50

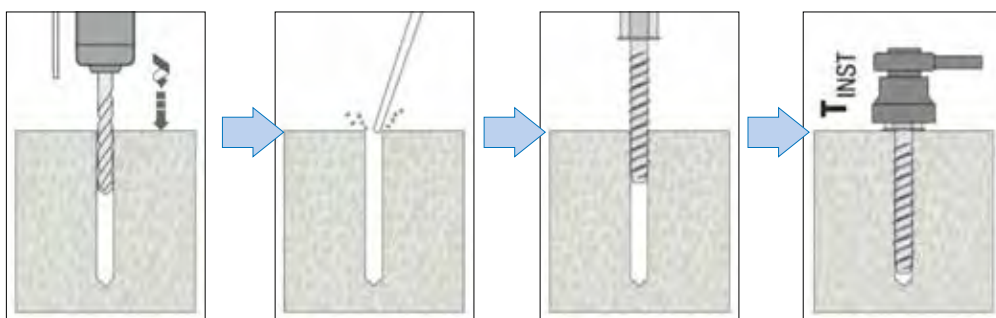

DRILL CORRECT DIAMETER HOLE TO CORRESPONDING DEPTH

CLEAN HOLE BY BLOWING TO REMOVE DRILLING DEBRIS AND DUST

INSERT ANCHOR INTO CONCRETE USING SUITABLE IMPACT WRENCH

TIGHTEN WITH TORQUE WRENCH TO RECOMMENDED TORQUE

DROP IN ANCHOR

X-DIA-M10

X-DIAL-M10 (LIPPED)



Part code M8	Part code M10	Part code M12	Description	Quantity
X-DIA-M8-B10	X-DIA-M10-B10	X-DIA-M12-B10	Drop In Anchor	Bag of 10
X-DIA-M8-B100	X-DIA-M10-B50	X-DIA-M12-B50	Drop In Anchor	MB Box of 100 - M10/M12 Box of 50
X-DIAL-M8-B100	X-DIAL-M10-B50	X-DIAL-M12-B50	Drop In Anchor Lipped	MB Box of 100 - M10/M12 Box of 50
X-DIA-ST			Drop In Anchor Setting Tool	Singles

CLAMPS AND CLIPS

UNLINED M8-M10 PIPE CLAMPS



Part code	Description	Quantity
X-PCU-15-18	Pipe clamp unlined - 15-18mm	Pack of 50
X-PCU-20-25	Pipe clamp unlined - 20-25mm	Pack of 50
X-PCU-26-30	Pipe clamp unlined - 26-30mm	Pack of 50
X-PCU-32-36	Pipe clamp unlined - 32-36mm	Pack of 50
X-PCU-38-43	Pipe clamp unlined - 38-43mm	Pack of 50
X-PCU-44-49	Pipe clamp unlined - 44-49mm	Pack of 50
X-PCU-56-61	Pipe clamp unlined - 56-61mm	Pack of 50
X-PCU-75-80	Pipe clamp unlined - 75-80mm	Pack of 50
X-PCU-87-92	Pipe clamp unlined - 87-92mm	Pack of 50
X-PCU-108-116	Pipe clamp unlined - 108-116mm	Pack of 25

TOOLS+

AVAILABLE AT YOUR LOCAL WHOLESALER

THE BOSCH IR LD 1.0 CO₂ LEAK DETECTOR IS SPECIFICALLY DESIGNED TO DETECT R-744 - CARBON DIOXIDE (CO₂). THIS LEAK DETECTOR MEETS / EXCEEDS EN14624 PERFORMANCE STANDARDS WITH AN ULTIMATE SENSITIVITY OF LESS THAN 2 G/YR.

THE BOSCH IR LD 1.0 CO₂ LEAK DETECTOR INCLUDES CARRYING CASE, SPARE FILTERS AND BATTERY CHARGER, AND COMES WITH A 2-YEAR WARRANTY.

BOSCH

SEE PAGE 159

CLAMPS AND CLIPS

BACK PLATE 810-HD

Back plate for mounting M8/M10 threaded rod. Secure threaded rod to a wall or ceiling safely.

Our Back Plate is used for Mounting M8 / M10 Threaded Rod safely to a wall or ceiling. Made from zinc plated steel, this back plate has a thickness of 3mm and comes in a box of 50.



Part code	Description	Material	Length	Width	Quantity
BackPlate-810-HD	Back Plate for Mounting M8/M10 Threaded Rod	2.5mm Zinc Plated Steel	80	30	50

RUBBER-LINED UNIVERSAL PIPE CLAMP

The M8-M10 rubber-lined pipe clamp are suitable for supporting all types of pipework including HVAC, boiler and drain. They come with noise suppressing rubber strips: 17dB(A) according to ISO 3822-1.



Part code	Description	Quantity
RLC-015	Pipe Clamp M8-10 Rubber lined 1/4" 11/15mm	Box of 50
RLC-020	Pipe Clamp M8-10 lined 3/8" 14-19mm	Box of 50
RLC-024	Pipe Clamp M8-10 lined 1/2" 20-24mm	Box of 50
RLC-029	Pipe Clamp M8-10 lined 3/4" 25-29mm	Box of 50
RLC-035	Pipe Clamp M8-10 lined 1" 32-36mm	Box of 50
RLC-044	Pipe Clamp M8-10 lined 1-1/4" 37-44mm	Box of 50
RLC-050	Pipe Clamp M8-10 lined 1-1/2" 44-50mm	Box of 50
RLC-058	Pipe Clamp M8-10 lined 50-58mm	Box of 50
RLC-068	Pipe Clamp M8-10 lined 2" 58-68mm	Box of 50
RLC-078	Pipe Clamp M8-10 lined 2-1/2" 68-78mm	Box of 50
RLC-088	Pipe Clamp M8-10 lined 78-88mm	Box of 50
RLC-098	Pipe Clamp M8-10 lined 3" 88-98mm	Box of 25
RLC-108	Pipe Clamp M8-10 lined 3-1/2" 98-108mm	Box of 25
RLC-118	Pipe Clamp M8-10 lined 4" 108-118mm	Box of 25
RLC-128	Pipe Clamp M8-10 lined 118-128mm	Box of 25
RLC-138	Pipe Clamp M8-10 lined 128-138mm	Box of 25
RLC-148	Pipe Clamp M8-10 lined 135-148mm	Box of 25
RLC-164	Pipe Clamp M8-10 lined 151-164mm	Box of 25
RLC-175	Pipe Clamp M8-10 lined 6" 165-175mm	Box of 10
RLC-185	Pipe Clamp M8-10 lined 175-185mm	Box of 10
RLC-205	Pipe Clamp M8-10 lined 194-205mm	Box of 10

HINGED LINED PIPE CLAMP

These hinged lined pipe clamps are suitable for supporting all types of pipework including HVAC, boiler and drain. They come with noise suppressing rubber strips: 17dB(A) according to ISO 3822-1.



Part code	Description	Quantity
RLC-020-GS	Single Hinged Pipe Clamp M8-10 lined 3/8" 15-19mm	Box of 50
RLC-024-GS	Single Hinged Pipe Clamp M8-10 lined 1/2" 20-24mm	Box of 50
RLC-029-GS	Single Hinged Pipe Clamp M8-10 lined 3/4" 25-29mm	Box of 50
RLC-035-GS	Single Hinged Pipe Clamp M8-10 lined 1" 32-36mm	Box of 50
RLC-042-GS	Single Hinged Pipe Clamp M8-10 lined 1-1/4" 40-45mm	Box of 50
RLC-053-GS	Single Hinged Pipe Clamp M8-10 lined 1-1/2" 48-53mm	Box of 50
RLC-065-GS	Single Hinged Pipe Clamp M8-10 Lined 2" 58-63mm	Box of 50

K-KLAMP PIPE AND INSULATION CLAMP

K-KLAMP eliminates having to double-wrap, glue and tape the insulation on strut-mounted clamps. K-KLAMP pipe and insulation coupling reduces the time required to insulate copper tubing used for refrigerant lines. Our clamp allows sections of closed-cell insulation to be secured at fixing points.



Copper pipe I.D.	Insulation wall thickness			
	Part code 3/8"	Part code 1/2"	Part code 3/4"	Part code 1"
1/4"	K38-14	-	K34-14	-
3/8"	K38-38	K12-38	K34-38	-
1/2"	K38-12	K12-12	K34-12	K100-12
5/8"	K38-58	K12-58	K34-58	K100-58
3/4"	K38-34	K12-34	K34-34	K100-34
7/8"	K38-78	K12-78	K34-78	K100-78
1"	K38-100	K12-100	-	-
1-1/8"	K38-118	K12-118	K34-118	K100-118
1-3/8"	K38-138	K12-138	K34-138	K100-138
1-5/8"	K38-158	K12-158	K34-158	K100-158
2-1/8"	K38-218	K12-218	K34-218	K100-218
2-5/8"	-	K12-258	K34-258	K100-258
3-1/8"	-	K12-318	K34-318	K100-318
3-5/8"	-	K12-358	K34-358	K100-358
4-1/8"	-	K12-418	K34-418	K100-418

FUSED SPUR SWITCHES

Part code	Description
X-FSBBMC	Fused Spur Metal Clad - with Back Box
X-FSNBBMC	Fused Spur Metal Clad - with Back Box & Neon
X-FS	Fused Spur Plastic - without neon
X-FSN	Fused Spur Plastic - with neon
X-BBSM-25	Back Box Surface Mount - 25mm
X-BBSM-35	Back Box Surface Mount - 35mm
X-BBSM26-25	Back Box 2 Gang - 25mm
X-BBSM2G-35	Back Box 2 Gang - 35mm
X-BSPS-10A	Plug Socket - 10 Amp
X-2GSW2W-10A	Switch 2 Gang - 10 Amp
X-3GSW2W-10A	Switch 3 Gang - 10 Amp
X-1GDPSW-13A	Switch 1 Gang - 13 Amp
X-2GDPSW-13A	Switch 2 Gang - 13 Amp
X-DPSW-20A	Switch Double Pole - 20 Amp
X-PT	Plug Top - 13 Amp



FUSED SPUR METAL



FUSED SPUR PLASTIC

ROTARY ENCLOSED ISOLATORS

Our insulated 3 and 4-pole rotary enclosed isolators are CE marked and suitable for disconnecting the power supply to outdoor air conditioning units. The isolators are weatherproof to IP65, easy-to-install, and conform to IEC 60947-3. They have a lockable OFF position and interlocking cover which can be removed only in the OFF position. Earth and neutral terminals included and M20/25 knockouts up to 63A.



Part code	No of poles	AMPS AC21	AC23 A 240VA	AC23 A 400VA	Cable capacity		Height	Width	Depth
					Solid	Stranded			
IS-3P-20A-S-G	3	20amp	5.5kW	3.7kW	1-16mm ²	0.75-10mm ²	125mm	100mm	120mm
IS-3P-32A-S-G	3	32 amp	11kW	7.5kW	1-16mm ²	0.75-10mm ²	125mm	100mm	120mm
IS-3P-20A-G	3	20amp	5.5kW	3.7kW	1-16mm ²	0.75-10mm ²	175mm	114mm	135mm
IS-3P-32A-G	3	30amp	11kW	7.5kW	1-16mm ²	0.75-10mm ²	175mm	114mm	135mm
IS-3P-40A-G	3	40amp	15kW	11kW	1-16mm ²	0.75-10mm ²	175mm	114mm	135mm
IS-3P-63A-G	3	63amp	22kW	18.5kW	1-16mm ²	0.75-10mm ²	175mm	114mm	135mm
IS-4P-20A-S-G	4	20amp	5.5kW	3.7kW	1-16mm ²	0.75-10mm ²	125mm	100mm	120mm
IS-4P-32A-S-G	4	32 amp	11kW	7.5kW	1-16mm ²	0.75-10mm ²	125mm	100mm	120mm
IS-4P-20A-G	4	20amp	5.5kW	3.7kW	1-16mm ²	0.75-10mm ²	175mm	114mm	135mm
IS-4P-32A-G	4	32amp	11kW	7.5kW	1-16mm ²	0.75-10mm ²	175mm	114mm	135mm
IS-4P-40A-G	4	40amp	15kW	11kW	1-16mm ²	0.75-10mm ²	175mm	114mm	135mm
IS-4P-63A-G	4	63amp	22kW	18.5kW	1-16mm ²	0.75-10mm ²	175mm	114mm	135mm

STUFFING GLANDS

Part code black	Part code white	Description	Quantity
X-CSG-20B-B10	X-CSG-20W-B10	Cable Stuffing Gland - 20mm	Pack of 10
X-CSG-25B-B10	X-CSG-25W-B10	Cable Stuffing Gland - 25mm	Pack of 10



CABLES

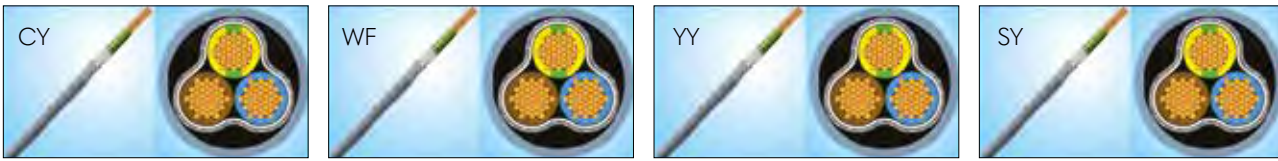

Part code CY	Part code WF	Part code YY	Part code SY	Description	Length
.75-2C-100				Cable 2 Core 0.75mm	100m
X-CY0.75C-2C-50	X-WF0.75-2C-50			Cable 2 Core 0.75mm	50m
X-CY1-2C-100	X-WF1-2C-100			Cable 2 Core 1mm	100m
X-CY1-2C-50	X-WF1-2C-50			Cable 2 Core 1mm	50m
X-CY1.5-2C-100		X-YY1.5-2C-100		Cable 2 Core 1.5mm	100m
X-CY1.5-2C-50				Cable 2 Core 1.5mm	50m
	X-WF0.75-3C-50			Cable 3 Core 0.75mm	50m
	X-WF1-3C-50			Cable 3 Core 1mm	50m
			X-SY1.5-3C-100	Cable 3 Core 1.5mm	100m
	X-WF1.5-3C-50			Cable 3 Core 1.5mm	50m
		X-YY2.5-3C-100	X-SY2.5-3C-100	Cable 3 Core 2.5mm	100m
	X-WF2.5-3C-50		X-SY2.5-3C-50	Cable 3 Core 2.5mm	50m
		X-YY0.75-4C-100		Cable 4 Core 0.75mm	100m
		X-YY0.75-4C-50		Cable 4 Core 0.75mm	50m
			X-SY1-4C-100	Cable 4 Core 1mm	100m
		X-YY1.5-4C-100	X-SY1.5-4C-100	Cable 4 Core 1.5mm	100m
		X-YY1.5-4C-50	X-SY1.5-4C-50	Cable 4 Core 1.5mm	50m
		X-YY2.5-4C-100	X-SY2.5-4C-100	Cable 4 Core 2.5mm	100m
		X-YY2.5-4C-50		Cable 4 Core 2.5mm	50m
			X-SY1.5-5C-100	Cable 5 Core 1.5mm	100m
			X-SY1.5-5C-50	Cable 5 Core 1.5mm	50m
			X-SY2.5-5C-100	Cable 5 Core 2.5mm	100m
			X-SY2.5-5C-50	Cable 5 Core 2.5mm	50m
		X-YY1.5-7C-100		Cable 7 Core 1.5mm	100m
		X-YY1.5-7C-50		Cable 7 Core 1.5mm	50m

CABLE TIES / CABLE TIE MOUNTS

Part code	Description	Quantity
X-CT100-2.5B-B100	Cable Tie 100mm x 2.52mm - Black	Pack of 100
X-CT300-4.8B-B100	Cable Tie 300mm x 4.8mm - Black	Pack of 100
X-CT300-4.8W-B100	Cable Tie 300mm x 4.8mm - White	Pack of 100
X-CT300-7.6B-B100	Cable Tie 300mm x 7.6mm - Black	Pack of 100
X-CT480-13B-B100	Cable Tie 480mm x 13mm - Black	Pack of 100
X-CT730-13B-B100	Cable Tie 730mm x 13mm - Black	Pack of 100
ID-BT-250	Cable Tie 250mm x 20mm - Ivory	Pack of 20
ID-BT-350	Cable Tie 350mm x 20mm - Ivory	Pack of 20
X-CB28-BL-B100	Cable Tie Base - 28mm Self Adhesive - Black	Pack of 100
X-CB28-W-B100	Cable Tie Base - 28mm Self Adhesive - White	Pack of 100

Part code	Description	Quantity
CTM-1	Cable Tie Mount - Screw Fixing	Pack of 100
CTM-2	Cable Tie Mount - with Studding	Pack of 100





FLEXI SUPPORT SYSTEMS

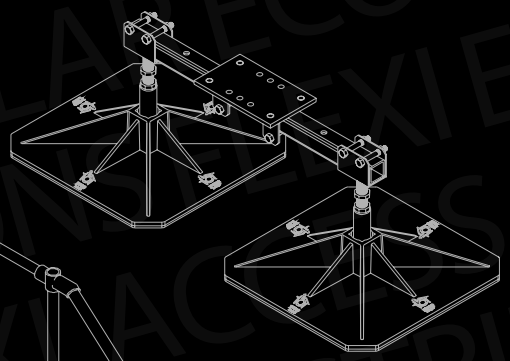

EVERYDAY

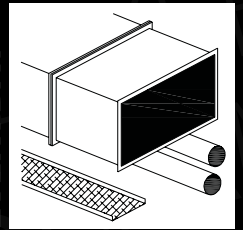

ACCESS

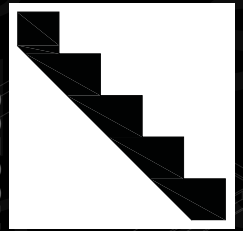

HEAVY

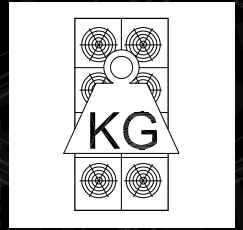

LIGHT

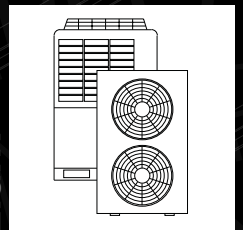

SOLAR



FLEXI RANGE
PAGE 109

sales@flexisupportsystems.com
www.flexisupportsystems.co.uk

OIL & LUBRICANT



VACUUM PUMP OIL

ROBINAIR PREMIUM HIGH VACUUM PUMP OIL

- Mineral oil
- Chemically engineered to maintain maximum viscosity at high running temperatures and to improve cold weather starts
- Thermal stability – resists break-down due to heat
- Lower moisture content – due to special packaging and handling procedures
- Performance of your pump depends largely on the quality and purity of the vacuum pump oil that you use



Part code	Description	Quantity
RA-13119	Premium High Vacuum Pump Oil, 0.475 Litres (16oz)	12
RA-13119	Premium High Vacuum Pump Oil, 0.95 Litres (32oz)	12
RA-13204	Premium High Vacuum Pump Oil, 3.8 Litres (128.5oz)	4

SYNTHETIC REFRIGERATION OIL



Part code	Description	Size
601231292	Fuchs Reniso Triton SEZ 22	5 L
600669812	Fuchs Renison Triton SEZ 32	1L
601231339	Fuchs Reniso Triton SEZ 32	5L
600646509	Fuchs Reniso Triton SE55	1L
601231414	Fuchs Reniso Triton SE 55	5 L
600680107	Fuchs Reniso Triton SEZ 68	1L
601231254	Fuchs Renison Triton SEZ 68	5L
601231278	Fuchs Reniso Triton SE 170	5L
600680442	Fuchs Reniso Triton SE 170	10L
600756512	Fuchs Reniso PAG 100	1L
600741105	Fuchs Reniso C85 E	1L
600360382	Fuchs Reniso C85 E	10L

RENISO C 85 E

SYNTHETIC REFRIGERATION OIL FOR CO₂ COMPRESSORS

Description

RENISO C 85 E is a special synthetic refrigeration oil based on synthetic esters. Selected additives guarantee excellent wear protection, also under the influence of CO₂ in the compressor. RENISO C 85 E has an excellent solubility / miscibility with the refrigerant carbon dioxide (R 744).

Application

RENISO C 85 E was developed for use mainly in refrigeration systems (deep-temperature systems, cascades, etc.) which are working with the refrigerant CO₂ (R 744). RENISO C 85 E has an excellent solubility / miscibility with CO₂ which guarantees the oil circulation in the refrigeration system, especially at low evaporation temperatures. RENISO C 85 E can be used in almost any application in industrial and commercial refrigeration, e.g. large-scale cooling plants. RENISO C 85 E can also be used in transcritical CO₂ cycles, e.g. air conditioning and heat pump systems, as well as container cooling systems.

Specifications

RENISO C 85 E is a refrigeration oil acc. to DIN 51503: KB – refrigeration oils for CO₂.

NSF H2 registration:
registration no. 146755

Advantages

- **High thermal stability**
 - **High chemical stability with CO₂ refrigerant**
 - **Excellent miscibility with CO₂ – also at low temperatures**
 - **Excellent deep-temperature flowability**
 - **Excellent lubrication at high pressure levels under CO₂ atmosphere**
 - **Excellent experience in test facilities and prototype systems**
 - **Used by leading compressor manufacturers.**
- Approvals:**

DORIN
GEA BOCK
GEA GRASSO
JOHNSON CONTROLS INTERNATIONAL



Properties	Unit		Test Method
Colour		0.5	DIN ISO 2049
Density at 15 °C	kg/m ³	993	DIN 51757
Flashpoint	°C	246	DIN ISO 2592
Kinematic viscosity at 40 °C	mm ² /s	80	DIN EN ISO 3104
at 100 °C	mm ² /s	10.6	
Viscosity index	-	118	DIN ISO 2909
Pourpoint	°C	- 42	DIN ISO 3016
Neutralisation number	mgKOH/g	0.03	DIN 51558-1
Water content	mg/kg	< 30	DIN 51777-2

RENISO TRITON SE/SEZ

SYNTHETIC REFRIGERATION OILS BASED ON POLYOL ESTERS (POE)
FOR HFC/FC REFRIGERANTS

Description

The refrigeration oils of the RENISO TRITON SE/SEZ series are based on synthetic esters that were especially developed for use with chlorine-free, fluorinated hydrocarbons (HFC/FC). In contrast to conventional refrigeration oils, these are miscible and compatible with polar HFC/FC.

Application

The RENISO TRITON SE/SEZ series is outstandingly suited for all refrigeration circuits, in which chlorine-free HFC/FC refrigerants, e.g. R134a, R404A or R410A are used. Depending on the viscosity, RENISO TRITON SE/SEZ refrigeration oils are recommended for hermetical, semi-hermetical and open piston compressors and for screw-type and turbo-compressors. RENISO TRITON SEZ 22 is especially suitable for deep-freeze systems operating with R23.

RENISO TRITON SE/SEZ products are also suitable for hydrocarbon refrigerants (e.g. propane, polypropylene, isobutane) and R22. In such cases please contact FUCHS prior to the usage.

Specifications

RENISO TRITON SE/SEZ lubricants fulfill and exceed the requirements acc. to DIN 51503-1, Groups KC, KD, KE.

Advantages/ Benefits

- Special synthetic polyolester
- Stable lubrication film even at high temperatures, outstanding lubricity
- Excellent solubility with HFC and FC refrigerants
- Very high thermal and chemical stability in the presence of fluorinated refrigerants
- Good viscosity-temperature behavior
- Excellent cold temperature flowability
- Secure oil return from the system, good heat transfer
- Good compatibility with elastomers and materials normally used in refrigeration circuits
- Readily biodegradable (ISO VG 32 and ISO VG 55)
- Approved by leading compressor manufacturers
- Ultra-dried



Product name	RENISO TRITON					
	SEZ 22	SEZ 32	SE 55	SEZ 68		
Properties	Unit					Test method
Density at 15 °C	kg/m ³	1003	1004	1009	970	DIN 51757
Flash point	°C	248	250	286	258	DIN ISO 2592
Color	-	0	0.5	1.0	0.5	DIN ISO 2049
Kinematic viscosity at 40 °C	mm ² /s	20	32	55	68	DIN EN ISO 3104
at 100 °C	mm ² /s	4.4	6.1	8.8	8.9	
Viscosity index	-	133	141	137	104	DIN ISO 2909
Pourpoint	°C	-57	-57	-48	-39	DIN ISO 3016
Neutralization number	mgKOH/g	0.03	0.03	0.03	0.03	DIN 51558-1
Water content	mg/kg	< 50	< 50	< 50	< 50	DIN 51777-2

RENISO PAG 46 AND RENISO PAG 100

FULLY SYNTHETIC REFRIGERATION OILS BASED ON SPECIAL POLYGLYCOLS (PAG) FOR R134A AC SYSTEMS

Description

Because of their Cl content, CFC refrigerants like R12 destroy the earth's ozone layer. This led all manufacturers to cease production of fully halogenized CFC's and introduce alternative products. This move is a reaction to the ban on CFC's and halons which established a timetable for the progressive ending of CFC production and use. Alternative refrigerants such as R134a have found general acceptance and are currently in use.

As classic refrigeration oils based on mineral oils, polyalphaolefins and alkylbenzene oils are not miscible with R134a, new refrigeration oils had to be developed, RENISO PAG-Series.

Application

Most car and truck air conditioning systems use Japanese- or American-made compressors and R134a refrigerants. These compressors require the use of synthetic, polyglycol-based refrigeration oils such as RENISO PAG 46 or RENISO PAG 100. The RENISO PAG products have an excellent miscibility and compatibility with R134a.

RENISO PAG 46 and RENISO PAG 100 are based on polar polyglycols. The structure of polyglycols make them hygroscopic (= absorb moisture). This means that special care must be taken when handling such products (always keep containers tightly sealed, use nitrogen to cover the refrigeration oil and store drums in dry, air conditioned rooms).

Advantages

- **Very high thermal stability**
- **Excellent miscibility and compatibility with R134a refrigerants (substitute for R12 refrigerants)**
- **Excellent viscosity-temperature behaviour (high VI)**
- **Low viscosity at low temperature, good flowability**
- **Stable lubricating film at high temperatures**
- **Good compatibility with all materials commonly used in refrigeration systems**
- **RENISO PAG 46 and RENISO PAG 100 are ultra-dried**



Product name		PAG 46	PAG 100	
Refrigeration oil type acc. to DIN 51503-1		KD	KD	
Characteristics	Unit			Test method
Colour		colourless	colourless	Visual
Kinematic viscosity at 40 °C	mm ² /s	55	120	DIN EN ISO 3104
at 100 °C	mm ² /s	10.6	21	
Viscosity index		187	202	DIN ISO 2909
Density at 15 °C	kg/m ³	992	996	DIN 51757
Flashpoint, Cleveland open cup	°C	240	240	DIN ISO 2592
Pourpoint	°C	- 45	- 45	DIN ISO 3016
Neutralisation number	mgKOH/g	0.04	0.04	DIN 51558-1
Water content	ppm	300	300	DIN 51777-2
Stability with R134a, 175 °C / 14 days	--	pass	pass	ASHRAE 97-89

	FUCHS oil	Competitor equivalent	Refrigerants	Approvals
MINERAL OILS	<ul style="list-style-type: none"> • RENISO KM 32 • RENISO KS 46 • RENISO KC 68 • RENISO KES 100 	-	<ul style="list-style-type: none"> • For NH3 and R22 	-
	<ul style="list-style-type: none"> • RENISO WF 5 A • RENISO WF 7 A • RENISO WF 10 A • RENISO WF 15 A 	-	<ul style="list-style-type: none"> • For hydrocarbons (e.g. R600a - hermetic compressors) 	-

SYNTHETIC HYDROCARBON OIL	<ul style="list-style-type: none"> • RENISO ULTRACOOOL 68 • RENISO ULTRACOOOL 100 	<ul style="list-style-type: none"> • PETROCANADA REFLO 68 • KLUBER RHT 68 • CPI 1009 68 • MOBIL GARGOYLE ARCTIC SHC NH 68 226E • TEXACO CAPELLA P68 • TOTAL LUNARIA NH 68 	<ul style="list-style-type: none"> • NH3 (Ammonia) 	NSF H1 registered
---------------------------	---	---	---	-------------------

POLYALPHAOLEPHINS (PAO) OILS	<ul style="list-style-type: none"> • RENISO SYNTH 68 	<ul style="list-style-type: none"> • PETROCANADA REFLO 68 • KLUBER RHT 68 • CPI 1009 68 • MOBIL GARGOYLE ARCTIC SHC NH 68 226E • TEXACO CAPELLA P68 • TOTAL LUNARIA NH 68 	<ul style="list-style-type: none"> • NH3 (Ammonia) 	NSF H1 registered
------------------------------	---	---	---	-------------------

POLYALKALINEGLYCOL (PAG) OIL	<ul style="list-style-type: none"> • RENISO PG68 	-	<ul style="list-style-type: none"> • AMMONIA AND HYDROCARBONS 	-
	<ul style="list-style-type: none"> • RENISO LPG 68 	-	<ul style="list-style-type: none"> • HYDROCARBONS, e.g. R290, R1270, R600a 	-

ALKYLBENZENES (AB)	<ul style="list-style-type: none"> • RENISO SP 32 • RENISO SP 46 • RENISO SP 100 • RENISO SP 220 	-	<ul style="list-style-type: none"> • R22 AND HYDROCARBONS 	-
	<ul style="list-style-type: none"> • RENISO S 3246 • RENISO S 68 	-	<ul style="list-style-type: none"> • R22, HYDROCARBONS AND AMMONIA 	-

	FUCHS oil	Competitor equivalent	Refrigerants	Approvals
POLYOLESTER (POE) OILS	<ul style="list-style-type: none"> • RENISO SEZ 22 • RENISO SEZ 32 • RENISO SEZ 55 • RENISO SEZ 68 • RENISO SEZ 80 F • RENISO SE 100/170/220 	<ul style="list-style-type: none"> • BITZER BSE 32 • CASTROL ICEMATIC SW22-32-46-68-80 • SOLTEST 22-32-46-68-80 • EMKARTE RL22H-32-46-68-80 • MOBIL EAL ARCTIC 22-32-46-68-80 • SHELL CLAVUS R22-32-46-68-80 • SUNISO SL 22-32-46-68-80 • TEXACO CAPELLO HFC 22-32-46-68-80 • TOTAL PLANET ELF ACD 22-32-46-68-80 • BITZER BSE 150 170 • CASTROL ICEMATIC SW100-170-220 • CPI SOLTEST 100-170-220 • EMKARTE RL100 H-170-220 • MOBIL EAL ARCTIC 100-170-220 • SHELL CLAVUS R100-170-220 • SUNISO SL 100-170-220 • TOTAL PLANET ELF ACD 100FY -150FY-220FY 	<ul style="list-style-type: none"> • Fully synthetic oil based on Polyol ester POE. Suitable for no ozone depleting FC/HFC refrigerants. RENISO TRITON SE/SEZ suitable for HFO and HFO/HFC refrigerants. Suitable with new refrigerants designed to replace R22 such as R422A/D and R417a 	<ul style="list-style-type: none"> • BITZER • BOCK • COPELAND (SEZ 32) • DANFOSS • FRIGOPOL • GRASSO (SCREW SEZ 68) • MCQUAY EUROPA • PRESTCOLD • ROTOCOLD • SABROE • SUTRAK • TRANE USA • ZANUSSI
	• RENISO TRITON SEZ 320	-	R22	-
	• RENISO SEZ 35 SC	-	HFC/FC	-

SPECIAL POLYOLESTER (POE) OIL	<ul style="list-style-type: none"> • RENISO C55 E • RENISO C85 E • RENISO C170 E 	-	<ul style="list-style-type: none"> • SUBCRITICAL CO2 • SUBCRITICAL/TRANSCRITICAL CO2 • SUBCRITICAL CO2 (screw compressor) 	<ul style="list-style-type: none"> • BITZER • DANFOSS • GEA BOCK • GRASSO • LINDE CARRIER • OBRIST • YORK
--------------------------------------	---	---	--	--

SPECIAL POLYALKALINE GLYCOL (PAG)	• RENISO ACC	-	• CO2 -AC CAR SYSTEMS	-
	• RENISO ACC 68 PAG	-	• CO2 -HEAT PUMPS/ CARS	-

SPECIAL POLYALKALINE GLYCOL (PAG) FOR MOBILE AC SYSTEMS	• RENISO PAG 46	-	• R134A, HYDROCARBONS, AMMONIA	-
	• RENISO PAG 100	-	• R1234YF, R134A MOBILE SYSTEMS	-
	• RENISO ACC HV	-	• CO2 MOBILE AC SYSTEMS	-

SPECIAL POE FOR MOBILE AC SYSTEMS - HYBRID AND ELECTRIC CARS	• RENISO TRITON SEZ 75 AC	-	• R1234YF, R134A, ELECTRIC COMPRESSORS	-
---	---------------------------	---	--	---

4 GOOD REASONS FOR USING RENISO REFRIGERATION OILS

Performance comparison RENISO TRITON SEZ 80 versus standard polyol ester (POE) refrigeration oils.

1 High thermo-chemical stability e.g. in Sealed Glass Tube Test (ASHRAE 97-2007)



Standard POE
refrigeration oils

High stability



RENISO TRITON SEZ 80

2 Very good miscibility with HFC/FC: e.g. in miscibility evaluation (DIN 51514)



Standard POE
refrigeration oils

Good miscibility

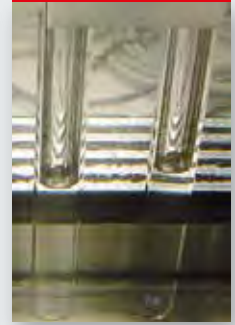

RENISO TRITON SEZ 80

3 Low varnish / low sludge formation e.g. in FUCHS In-house test (evaluation of oil sludge in beaker with bearing roller after 168h/135 °C)



Standard POE
refrigeration oils

No sludge



RENISO TRITON SEZ 80

4 Reliable wear protection e.g. in bearing wear testing (DIN 51819-3)



Standard POE
refrigeration oils

No wear



RENISO TRITON SEZ 80

TOOLS



hilmar[®] RANGE

PAGE 201



Quick-Engage Flare and Swage
1838947

RECOVERY MACHINES



RECOVERY MACHINES

BOSCH RG-4.0



REFRIGERANT RECOVERY MACHINE FROM BOSCH. EXTERNALLY CERTIFIED FOR A1, A2L AND A3 REFRIGERANTS WITH CONFIRMATION NO. 2018/SX/PV/222

- Recovers all commonly used CFC, HFC, HCFC Refrigerants
- Suitable for A2L Refrigerants such as R32 and R1234YF
- Suitable for A3 Refrigerants such as R290 and R600a
- Oil-less compressor suitable for liquid and vapor
- Fully automatic high & low pressure reset
- Available in 110V and 240V
- 1 year warranty



Technical information	
High Pressure Cut Out	550psi / 38.5 bar
Compressor	Single Cylinder 1/2 HP, 1700-1750 rpm (110V) 1/2 HP, 1400-1450 rpm (240V)
Approvals	CE, UL, ARI and TUV
Weight	14.6kg
Voltage	240V 50-60Hz 110V 50-60Hz
Refrigerant Examples	R1234YF, R134A, R22, R32, R290, R401B, R401C, R402A, R402B, R404A, R406A, R407A, R407B, R407C, R407D, R408A, R409A, R410A, R411A, R411B, R412A, R417A, R422A, R422D, R427A, R500, R502, R507, R509, R600a

Recovery Rates (Max Capacity)	
PUSH / PULL	6.84 Kg/min
	410.5 Kg/hr
Liquid	2.03 Kg/min
	122.1 Kg/hr
Vapour	0.17 Kg/min
	10.7 Kg/hr

Part code	Description	Quantity
BOSCH RG-4.0A	Bosch Recovery Unit - 240V 50-60Hz	1
BOSCH RG-4.0B	Bosch Recovery Unit - 110V 50-60Hz	1

EXPLODED DIAGRAM

CODE	No.	PRODUCT
RGB400100	1	Tube - Manifold to compressor inlet
RGB400120	2	Compressor
RGB400130	3	Start capacitor (only for 115 V)
RGB400150	4	Motor 230 V
RGB400140	4	Motor 115 V
RGB400290	5	Motor bracket 230 V
RGB400160	5	Motor bracket 115 V
RGB400280	6	LH enclosure
RGB480120	7	Knob - Main power switch
RGB480130	8	Pump bracket
RGB480140	9	Main power switch
RGB400180	10	Electrical fan 230 V
RGB400170	10	Electrical fan 115 V
RGB480150	11	Manifold assembly
RGB480160	A	Gauge - High pressure
RGB480170	B	Gauge - Low pressure
RGB480180	C	Switch - High pressure
RGB480190	D	Switch - Low pressure
RGB400190	12	Grill - gray
RGB480200	13	Knob - Ball valve (Red)
RGB480210	14	Knob - Ball valve (Blue)
RGB480220	15	Knob - Ball valve (Black)

CODE	No.	PRODUCT
RGB480230	16	HMI cover
RGB480240	17	Front Panel
RGB480250	18	Condenser
RGB480260	19	RH Enclosure
RGB400200	20	Tube- Manifold to compressor outlet
RGB400210	21	Interface - Motor and compressor
RGB400220	22	Coupler
RGB480310	23	Circuit breaker 8 A, 230 V
RGB400300	23	Circuit breaker 12 A, 115 V

CODE	OTHER PARTS
RGB400230	Piston repair kit
RGB400240	Valve repair kit
RGB400250	Compressor repair kit
RGB400260	Shaft seal repair kit
RGB400270	Shaft replacement kit

CODE	OTHER PARTS
RGB480270	Filter drier
RGB480280	Filter hose
RGB480290	Filter / hose kit
RGB480300	Inlet fitting with filter screen

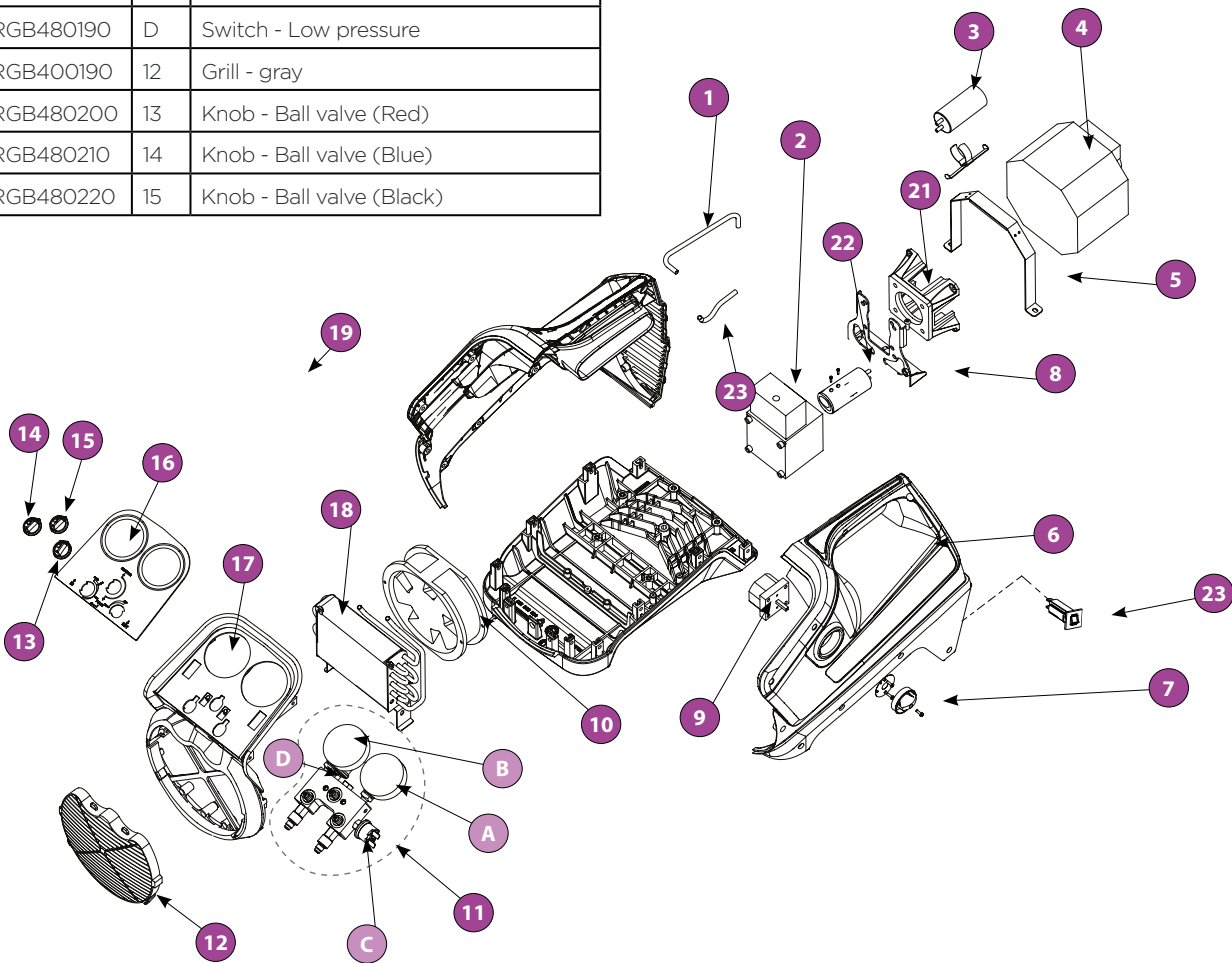

PROMAX RG 3000

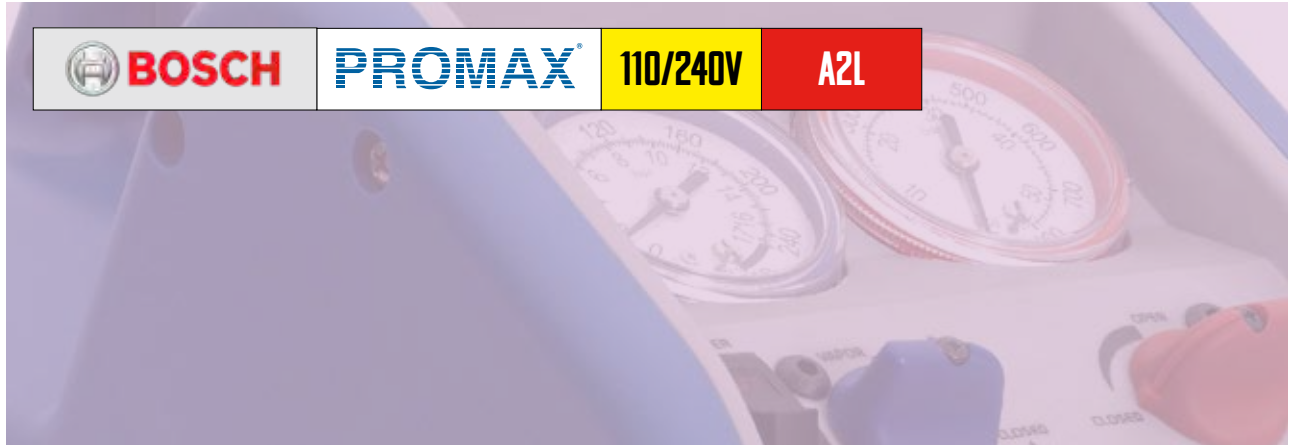

ULTRA COMPACT REFRIGERANT RECOVERY MACHINE FROM PROMAX

- Ultra compact and lightweight
- Our smallest, lightest recovery machine
- Recovers all commonly used CFC, HFC, HCFC Refrigerants
- Suitable for A2L Refrigerants such as R32 and R1234YF
- Oil-less compressor suitable for liquid and vapour
- Available in 110V and 240V
- 1 year warranty



Technical information	
High Pressure Cut Out	550psi / 38.5 bar
Compressor	Single Cylinder 1/3 HP, 1700-1750 rpm (110V) 1/3 HP, 1400-1450 rpm (240V)
Approvals	CE, UL, ARI and TUV
Weight	8kg
Voltage	240V 50-60Hz 110V 50-60Hz
Refrigerant Examples	R1234YF, R22, R32, R134A, R401B, R401C, R402A, R402B, R4040A, R406A, R407A, R407B, R407C, R407D, R408A, R409A, R410A, R411A, R411B, R412A, R417A, R422A, R422D, R427A, R500, R502, R507, R509 and others

Recovery Rates (Max Capacity)	
PUSH / PULL	3.8 Kg/min
	229.13 Kg/hr
Liquid	0.97 Kg/min
	58.25 Kg/hr
Vapour	0.136 Kg/min
	8.18 Kg/hr

Part code	Description	Quantity
RG 3000 E	RG 3000 E Promax Ultra Compact Recovery Unit - 240V 50Hz 1	1
RG 3000 110V	Promax Ultra Compact Recovery Unit - 110V 50Hz	1

EXPLODED DIAGRAM

CODE	No.	PRODUCT
-	1	RG3000 Condenser 105-201234-001
-	2	RG3000 Motor Clamp Left
-	3	RG3000 Motor Clamp Right
-	4	RG3000 110V Motor
-	4	RG3000 240V Motor
-	5	RG3000 Compressor
-	6	RG3000 Manifold Assy. Low Side
-	7	RG3000 Manifold Assy. High Side
-	8	RG3000 Power Switch

CODE	No.	PRODUCT
-	9	RG3000 Power Receptacle RS
-	10	RG3000 Fuse Holder
-		Fuse, slow blow 8amp
-	11	RG3000 110V Capacitor Motor Start
-	11	RG3000 240V Capacitor, Motor Start
-	12	RG3000 Fan 240
-	12	RG3000 Fan 110
-	13	RG3000 Coupler

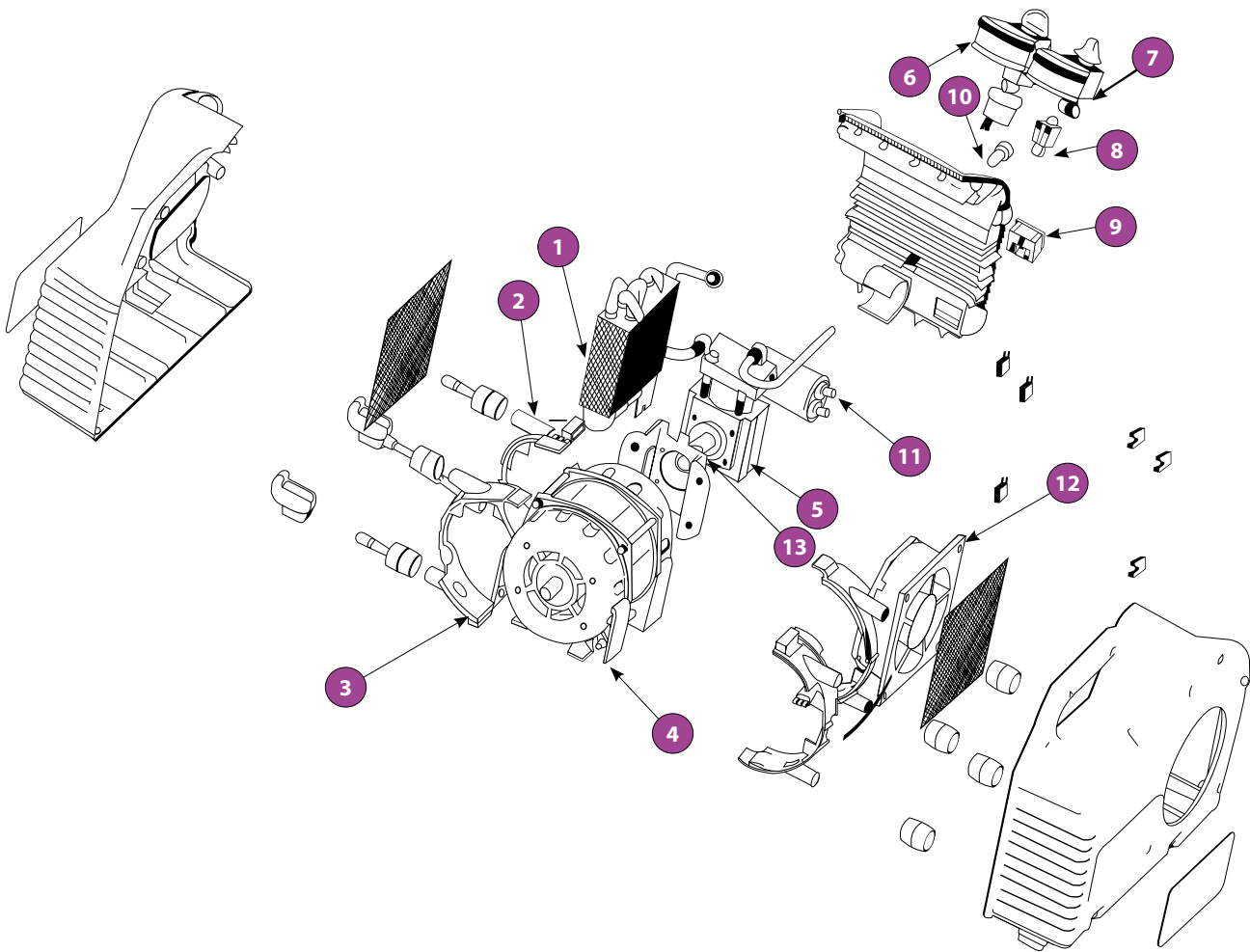

RECOVERY MACHINES



PROMAX MINIMAX



COMPACT REFRIGERANT RECOVERY MACHINE FROM PROMAX

- Minimum size, maximum performance
- Recovers all commonly used CFC, HFC, HCFC Refrigerants
- Suitable for A2L Refrigerants such as R32 and R1234YF
- Oil-less compressor suitable for liquid and vapour
- Manual high pressure reset switch
- Available in 110V and 240V
- 1 year warranty



Technical information	
High Pressure Cut Out	550psi / 38.5 bar
Compressor	Single Cylinder 1/3 HP, 1700-1750 rpm (110V) 1/3 HP, 1400-1450 rpm (240V)
Approvals	CE, UL, ARI and TUV
Weight	11kg
Voltage	240V 50-60Hz 110V 50-60Hz
Refrigerant Examples	R1234YF, R22, R32, R134A, R401B, R401C, R402A, R402B, R4040A, R406A, R407A, R407B, R407C, R407D, R408A, R409A, R410A, R411A, R411B, R412A, R417A, R422A, R422D, R427A, R500, R502, R507, R509 and others

Recovery Rates (Max Capacity)	
PUSH / PULL	5.9 Kg/min
	354 Kg/hr
Liquid	1.5 Kg/min
	90 Kg/hr
Vapour	0.15 Kg/min
	9 Kg/hr

Part code	Description	Quantity
MINIMAX	Promax Minimax Comp act R recovery U nit - 240V 50-60Hz	1
MINIMAX-E	Promax Minimax Comp act R ecovery Unit - 11 0V 50-60Hz	1

EXPLODED DIAGRAM

CODE	No.	PRODUCT
-	1	Bell Housing
-	2	Compressor Bracket
-	3	Bracket - Motor
-	4	Case
-	5	Capacitor
-	6	Coupler
-	7	Compressor
-	8	Condenser
-	9	Fan 110V
-	9	Fan 240V
-	10	Fan Screen - outlet
-	10	Fan Screen - inlet
-	11	Flare Fitting 45°
-	12	Fuse, slow blow 8amp
-	13	Gauge - Input LP (Blue) 500psi
-	14	Gauge - Output HP (Red) 800psi
-	15	Gauge Lens (2)
-	16	HP Switch Automatic

CODE	No.	PRODUCT
-	16	HP switch 240V
-	17	Inlet Hose 4"
-	18	Inlet Filter dryer (with hoses)
-	18	Inlet Filter dryer (without hoses)
-	19	Knob - Black
-	20	Knob - Blue
-	21	Knob - Red
-	22	Manifold
-		Manifold Valve Seal
-	23	Motor 115V/60Hz
-	23	Motor 230V/60Hz
-		Motor Clamp
-		Neoprene Ball 5/16" GRD 1 - manifold part
-	24	Power Cord 110V
-	24	Power Cord 240V
-		Rivnut 10-24
-	25	Switch -On/Off
-	26	Switch - Start

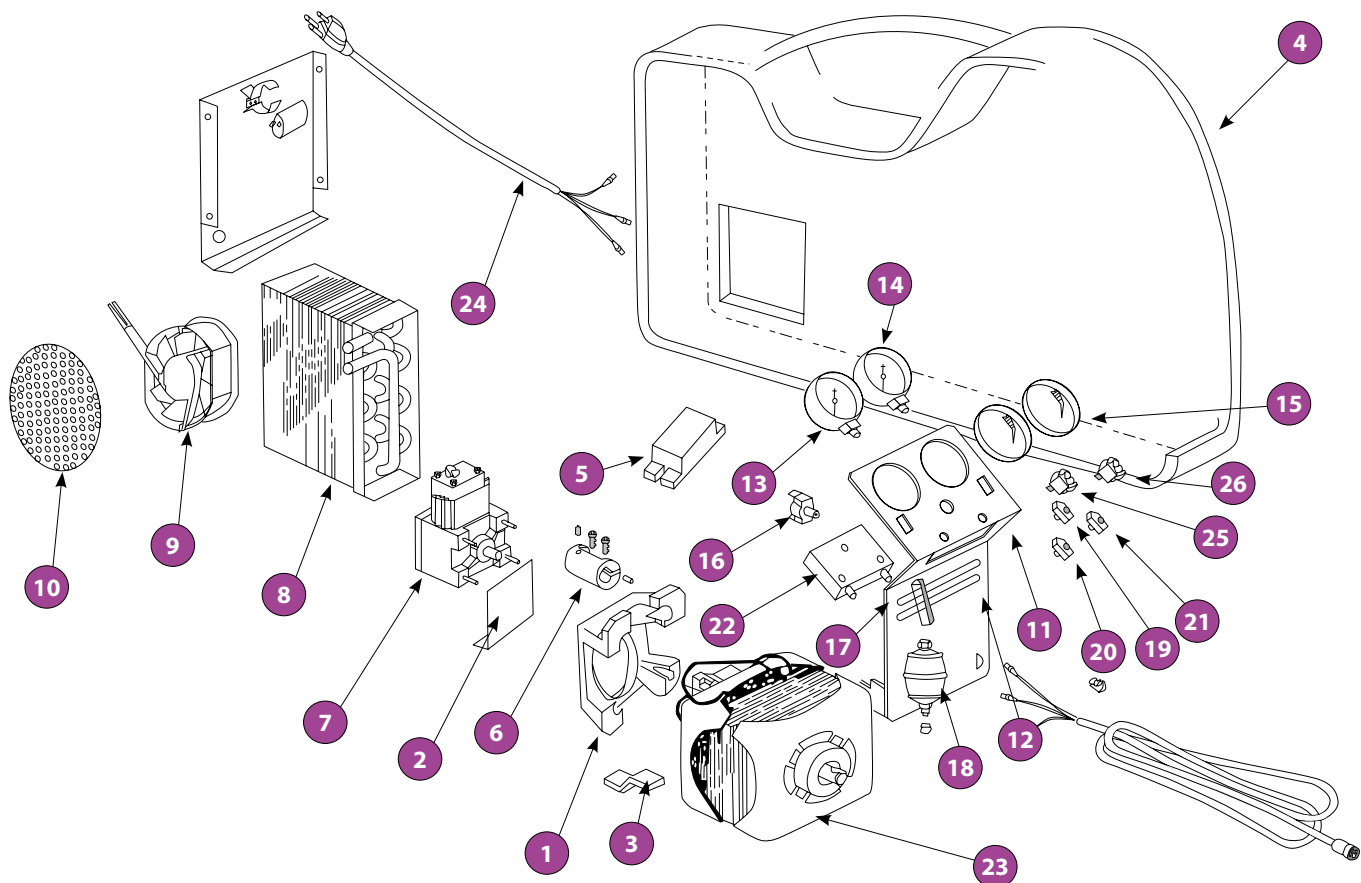

RECOVERY MACHINES

PROMAX RG 5410A



COMPACT REFRIGERANT RECOVERY MACHINE FROM PROMAX

- Recovers all commonly used CFC, HFC, HCFC Refrigerants
- Suitable for A2L Refrigerants such as R32 and R1234YF
- Oil-less compressor suitable for liquid and vapour
- Manual high pressure reset switch
- Selectable low pressure switch
- Available in 110V and 240V
- 1 year warranty



Technical information	
High Pressure Cut Out	550psi / 38.5 bar
Compressor	Single Cylinder 1/2 HP, 1700-1750 rpm (110V) 1/2 HP, 1400-1450 rpm (240V)
Approvals	CE, UL, ARI and TUV
Weight	13.5kg
Voltage	240V 50-60Hz 110V 50-60Hz
Refrigerant Examples	R1234YF, R22, R32, R134A, R401B, R401C, R402A, R402B, R4040A, R406A, R407A, R407B, R407C, R407D, R408A, R409A, R410A, R411A, R411B, R412A, R417A, R422A, R422D, R427A, R500, R502, R507, R509 and others

Recovery Rates (Max Capacity)	
PUSH / PULL	6.22 Kg/min
	373 Kg/hr
Liquid	1.85 Kg/min
	111 Kg/hr
Vapour	0.16 Kg/min
	9.6 Kg/hr

Part code	Description	Quantity
RG 5410A E240V	Promax Recovery Unit - 240V 50-60Hz	1
RG 5410A E	Promax Recovery Unit - 110V 50-60Hz	1

EXPLODED DIAGRAM

CODE	No.	PRODUCT
-	1	Bell Housing
-	2	Capacitor
-	2	Capacitor [EXTREME]
-	3	Check Valve [EXTREME]
-	4	Condenser
-	5	Compressor CP1320
-	6	Compressor Bracket
-	7	Coupler
-	7	Coupler [EXTREME]
-	8	Fan Assembly 110V
-	8	Fan Assembly 240V
-	9	Fan Grill
-	10	Flare Cap 1/4"
-	11	Flare Fitting 45°
-	12	Fuse, slow blow 8amp
-	13	Fuse Holder
-	14	Gauge - Input LP (blue)
-	14	Gauge - Input LP (blue) [EXTREME] 500psi
-	15	Gauge - Output HP (red)
-	15	Gauge - Output HP (red) [EXTREME]
-	16	Gauge Lens (2)
-	17	HP Switch

CODE	No.	PRODUCT
-	18	Inlet Filter dryer (with hose)
-	18	Inlet Filter dryer (without hose)
-	19	Inlet Hose 4"
-	20	Knob - Black
-	21	Knob - Blue
-	22	Knob - Red
-	23	Manifold
-		Manifold Valve Seal
-	24	Motor 110V
-	24	Motor 230V
-	24	Motor 110V [EXTREME]
-	24	Motor 230V [EXTREME]
-		Motor Clamp
-		Neoprene Ball 5/16"
-		GRD 1 - manifold part
-	25	Male Kettle Lead 240V
-	25	Male Kettle Lead 110V
-		Rivnut 10-24
-	26	Switch - Start
-	27	Switch - On/Off
-	28	Switch - Vacuum Select
-	25	Vacuum Sensor

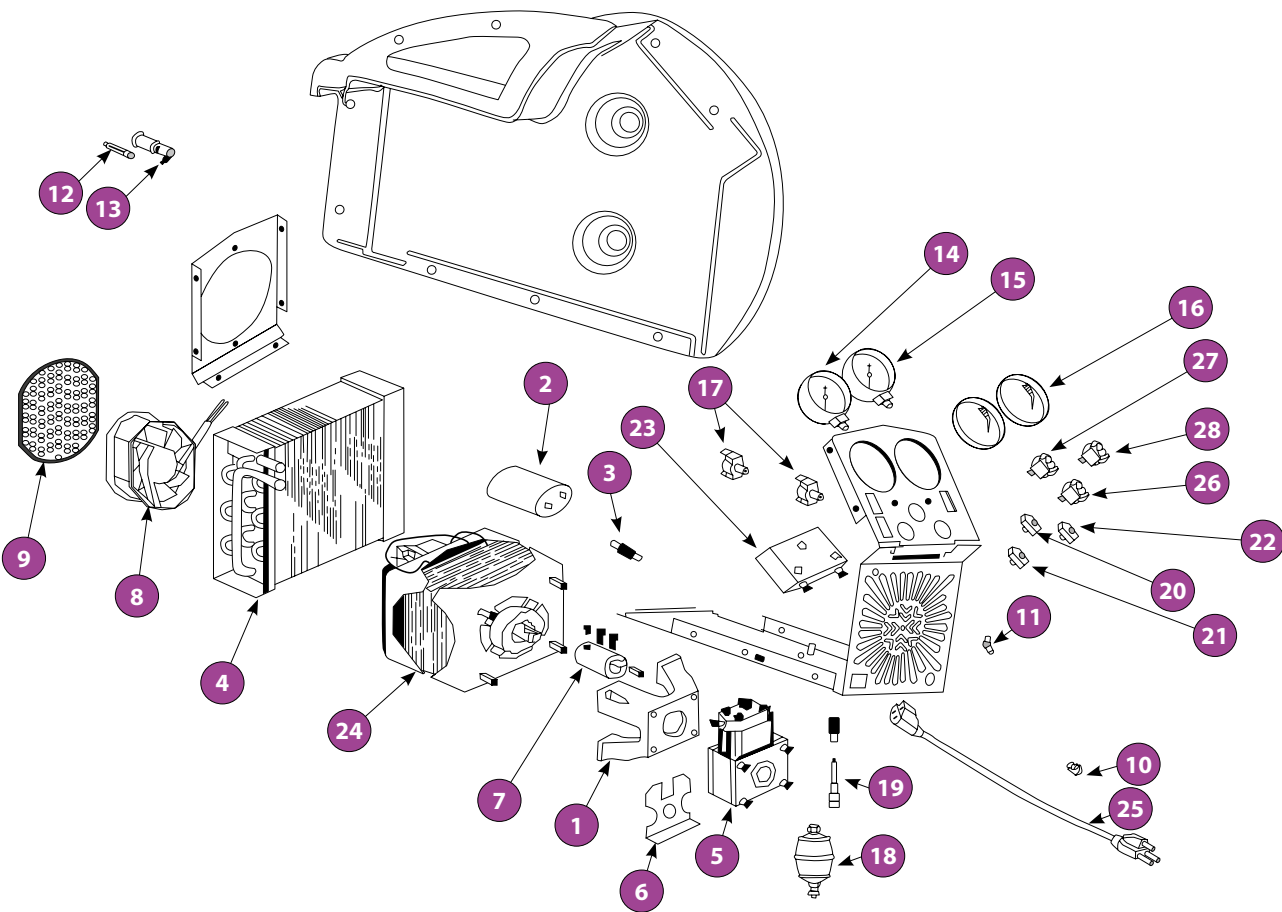

RECOVERY MACHINES

COMPARISON CHARTS



BOSCH RG-4.0



PROMAX RG3000



PROMAX MINIMAX



PROMAX RG5410A

Technical information	BOSCH RG-4.0	PROMAX RG3000
Motor	1/2 HP / 360 Watt	1/3 HP / 240 Watt
Max. Working Pressure	38.5 Bar	38.5 Bar
No. of cylinders	1	1
Norm	EN 35421	EN 35421
Approvals	CE, UL, ARI and TÜV	CE, UL, ARI and TÜV
Filter / dryer	Yes	Yes
HP safety switch	Yes	Yes
Dimensions	450 x 250 x 350 mm	310 x 235 x 175 mm
Weight	14.6 kg	8 kg

Technical information	PROMAX MINIMAX	PROMAX RG5410A
Motor	1/2 HP / 360 Watt	1/3 HP / 240 Watt
Max. Working Pressure	38.5 Bar	38.5 Bar
No. of cylinders	1	1
Norm	EN 35421	EN 35421
Approvals	CE, UL, ARI and TÜV	CE, UL, ARI and TÜV
Filter / dryer	Yes	Yes
HP safety switch	Yes	Yes
Dimensions	406 x 250 x 222 mm	485 x 325 x 245 mm
Weight	11 kg	13.5 kg

Part code	Description	Quantity
BOSCH RG-4.0A	Bosch Recovery Unit - 240 V 50-60Hz	1
BOSCH RG -4.0B	Bosch Recovery Unit - 110 V 50-60Hz	1
RG 3000 E2 30V	Promax Ultra Compact Recovery Unit - 240V 50Hz only	1
RG 3000 E	Promax Ultra Compact Recovery Unit - 110V 50Hz only	1
MINIMAX	Promax Minimax Compact Recovery Unit - 240V 50-60Hz	1
MINIMAX E	Promax Minimax Compact Recovery Unit - 110V 50-60Hz	1
RG 5410A E240V	Promax Recovery Unit - 240V 50-60Hz	1

LEAK DETECTION

LEAK DETECTION



LEAK DETECTION

BOSCH CS LD 1.0



LEAK DETECTOR

- One sensor, one tool
- Detects Halogenated CFC, HCFC, HFC, HFO compounds, HC refrigerants, Tracer Gas (95 %N₂/5 %H₂ mixture), ammonia, butane and propane
- Meets or exceeds EN14624 performance standards
- Ultimate Sensitivity of less than 1 g/yr
- Electronic sensor lasts > 5 years
- Large 61 mm backlit graphic LCD
- Audible alarm with Mute and Visual Leak Size Indicator
- Leak tracing mode to pinpoint hard to find leaks
- Rubber keypad provides positive actuation and tactile feedback
- Ergonomic design with TPU overmold and ambidextrous operation
- Includes carrying case, spare filters and battery charger



Technical information	Bosch CS LD 1.0
Dimensions (L x W x H)	218 x 83 x 51 mm
Probe Length	413 mm
Weight	452 grams
Sensor Life	Approximately 5 years under normal usage
Warm Up Time	Normally 20 - 30 seconds, 45 seconds Max.
Ultimate Sensitivity	< 1 g/yr
Power Supply	Li-Ion rechargeable cell
Battery Life (per charge)	8 hours
Recharge time	≤ 3 hours
Operating Temperature & Humidity	-20° C to 50° C; 95 % RH max.
IP Rating	IP IP51

Code	Description	Quantity
BOSCH CS LD 1.0	Leak Detector	1

BOSCH IR LD 1.0



LEAK DETECTOR

The BOSCH IR LD 1.0 CO₂ leak detector is specifically designed to detect R-744 - Carbon Dioxide (CO₂). This leak detector meets / exceeds EN14624 performance standards with an ultimate sensitivity of less than 2 g/yr. The BOSCH IR LD 1.0 CO₂ leak detector includes carrying case, spare filters and battery charger, and comes with a 2-year warranty.

- Infrared sensor lasts for years and is stable and reliable
- Large 61 mm backlit graphic LCD
- Audible alarm with mute and visual leak size indicator
- Rechargeable Li-Ion battery provides superior performance and saves on operating costs
- Rubber keypad provides positive actuation and tactile feedback
- Ergonomic design with TPU overmold and ambidextrous operation



Technical information	BOSCH IR LD 1.0
Dimensions (L x W x H)	218 x 83 x 51 mm
Probe Length	413 mm
Weight	452 grams
Sensor Life	Approximately 5 years under normal usage
Warm Up Time	Normally 50 - 60 seconds, 90 seconds Max.
Ultimate Sensitivity	< 2 g/yr
Power Supply	Li-Ion rechargeable cell
Battery Life (per charge)	8 hours
Recharge time	≤ 3 hours
Operating Temperature & Humidity	-20°C to 50°C - 95% RH MAX
IP Rating	IP51

Code	Description	Quantity
BOSCH-IR-LD	Leak Detector	1

TIF XP-1A



ELECTRONIC LEAK DETECTOR FROM TIF

The TIF XP-1A features a mechanical pump which ensures that moving air from the immediate environment is continuously flowing over the sensing tip for it to sample.

The sensing tip is monitored by the microprocessor 4000 times a second and can detect leaks down to 3 grams of refrigerant per year. The kit comes complete with 2 sensors, (each with a 20 hour life), batteries, a hard carry case and a two year warranty.

- Detects all halogenated refrigerants
- Variable frequency audible alarm
- LED lights to indicate a leak
- Constant power indication
- Suitable for A2L Refrigerants such as R32 and R1234YF
- Mute Button
- 2-year warranty



Technical information	
Ultimate sensitivity	3 gr/yr
Power supply	2 x 'C' Batteries
Battery life	Approx. 30 hours
Sensor life	20 hours
Operating temperature	-20°C to 52°C

Part code	Description	Quantity
TIF-XP-1A	Automatic Halogen refrigerant leak detector	1
TIF-XP-2	Maintenance kit (3 tips with protectors)	1

REFRIGERANT WEIGHING SCALES



TIF-9030E

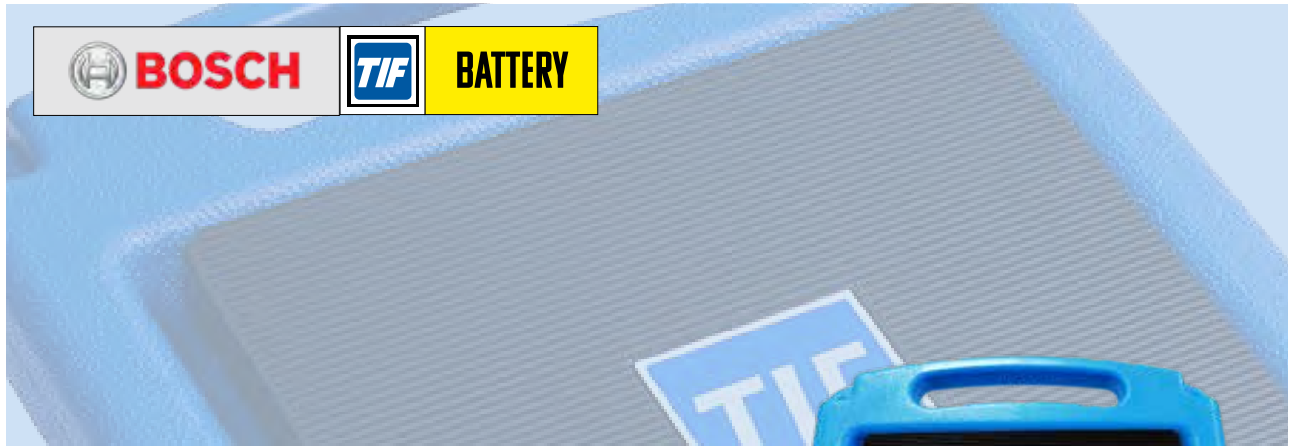

COMPACT REFRIGERANT SCALE UP TO 100KG

- Compact design
- Extremely durable
- Range up to 100kg
- Display weight in kg, oz, lbs
- Resolution 10g
- Easy to use: On/Off - Units - Zero buttons
- 9V battery operated
- Overload protected
- Inclusive Shoulder bag
- CE approved
- 1-year warranty

**CALIBRATION
CERTIFICATION
SERVICE AVAILABLE
ON ALL SCALES**



Technical information	
Capacity	Up to 100kg
Accuracy	± 0.5% of reading ± 1 digit
Resolution	10 gram
Platform dimensions	230mm (W) 230mm (L)
Weight	2.4kg
Battery type	1 x 9V alkaline battery
Battery life	± 20 hours
Operating temperatures	-10°C to 49°C
Case	No
Bag	Yes

Part code	Description	Quantity
TIF-9030E	TIF Compact Refrigerant Scale up to 100 kg	1

TIF-9055

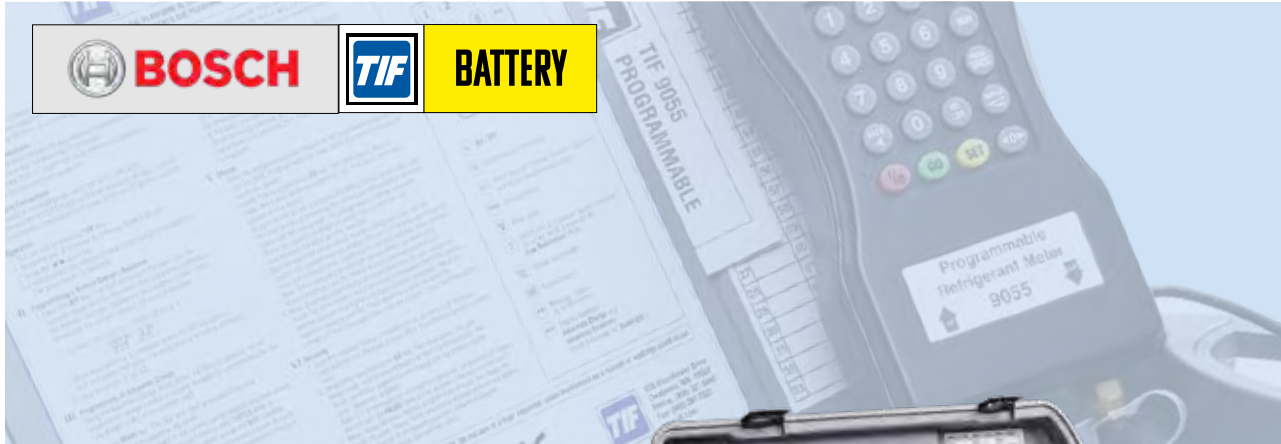

PROGRAMMABLE CHARGING / RECOVERY SCALE UP TO 100KG

- 100kg (220 lbs) capacity
- Allows automatic Charging or Recovery operations
- Colour-coded keypad controls
- Three display modes – kg, lbs/oz, Decimal Pounds
- Very High Resolution – 4g / 0.2 oz / 0.010 lbs
- Can be used with all refrigerants, including (R410A)
- Advanced Charge and Recovery Modes – uses tare weight and max. capacity of cylinder to calculate maximum charge/recovery available
- Removable platform and control box with prop stand/ hanging hook
- Compact Design – completely portable, battery powered
- Low battery indicators
- 1-year warranty



**CALIBRATION
CERTIFICATION
SERVICE AVAILABLE
ON ALL SCALES**

Technical information	
Capacity	Up to 100kg
Accuracy	± 0.5% of reading ± 1 digit
Resolution	4 gram
Platform dimensions	230mm (W) 230mm (L)
Weight	4kg
Battery type	1 x 9V alkaline battery and 4 x 1.5V AA batteries
Battery life	± 30 hours
Operating temperatures	-10°C to 45°C
Case	No
Bag	Yes

Part code	Description	Quantity
TIF-9055	TIF Programmable Charging / Recovery Scale up to 100 kg	1

TIF-9060S

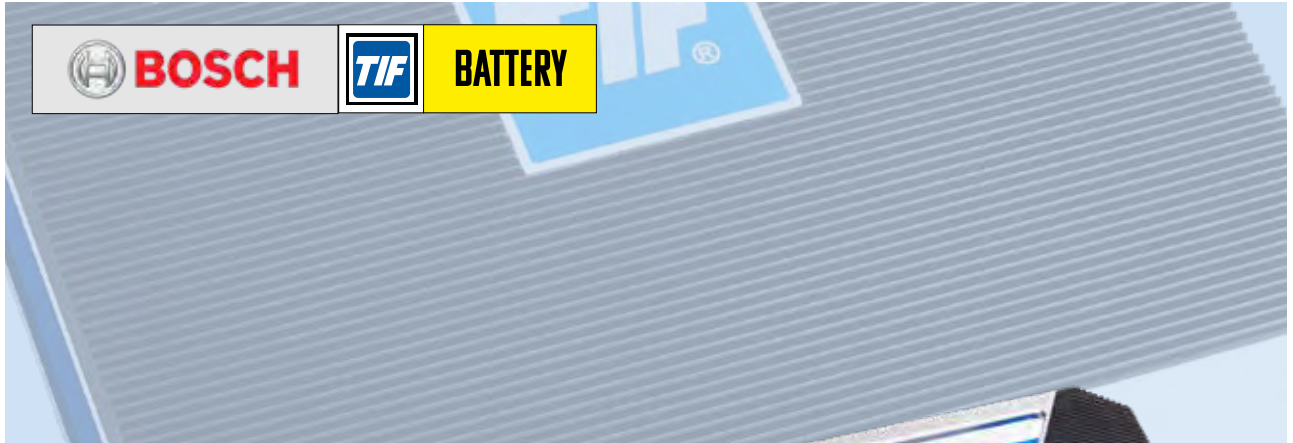
**HEAVY-DUTY ALUMINIUM SCALE
UP TO 150KG**

- Maximum capacity 150kg
- Extremely large platform
- 6 digit LCD readout
- Easy to handle
- Three units to select from kg, lbs, lbs/ozs
- Resolution 10g, 0,02 lbs and 0,5 oz
- Low Battery indicator (<7.5 V DC)
- Platform 270 x 260 mm
- Overload protected
- Includes nylon carrying case
- CE approved
- 1-year warranty

**CALIBRATION
CERTIFICATION
SERVICE AVAILABLE
ON ALL SCALES**



Technical information	
Capacity	150kg
Accuracy	± 0.5% of reading ± 1 digit
Resolution	2 or 4 gram
Platform dimensions	260mm (W) 270mm (L)
Weight	5.3kg
Battery type	1 x 9V alkaline battery
Battery life	± 20 hours
Operating temperatures	-10°C to 49°C
Case	No
Bag	Yes

Part code	Description	Quantity
TIF-9060S	TIF Heavy-Duty Aluminium Scale up to 150 kg	1

CONDENSATE PUMPS AND ACCESSORIES

MINI PUMPS

DiversiTech International stock a range of mini condensate pumps ideal for split air conditioning systems, small enough to be placed in the unit, or within trunking. We also provide mini pump options that come with an elbow and length of trunking.



EC-1 (PUMP ONLY)



WHISPA-Q MINI AND TRUNKING



EC-1 KIT with elbow and trunking

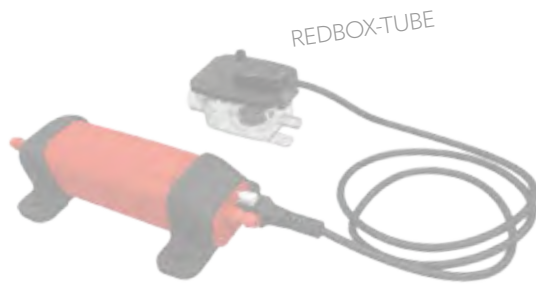

REDBOX-TUBE

Part code	Description	Max head	Max flow	dB(A)	Dimensions mm (HxWxD)	Discharge size (inches)
EC-1	1 Litre Tank Pump	10m	10 LPH	21	104x46x58	1/4"
EC-1 KIT	Mini pump with trunking	10m	10 LPH	21	104x46x58	1/4"
REDBOX-TUBE	Mini pump	3m	20 LPH	21	159.8x36.8x-	
WHISPA-Q-TRUNK	Mini pump with trunking	6m	16 LPH	< 21	-	
MF-2	Mini Flowwatch 2	10m	12 LPH	< 21	800x150x80	

FIND ME ON PAGE 17

COMPARISON CHART

COMPARISON CHARTS

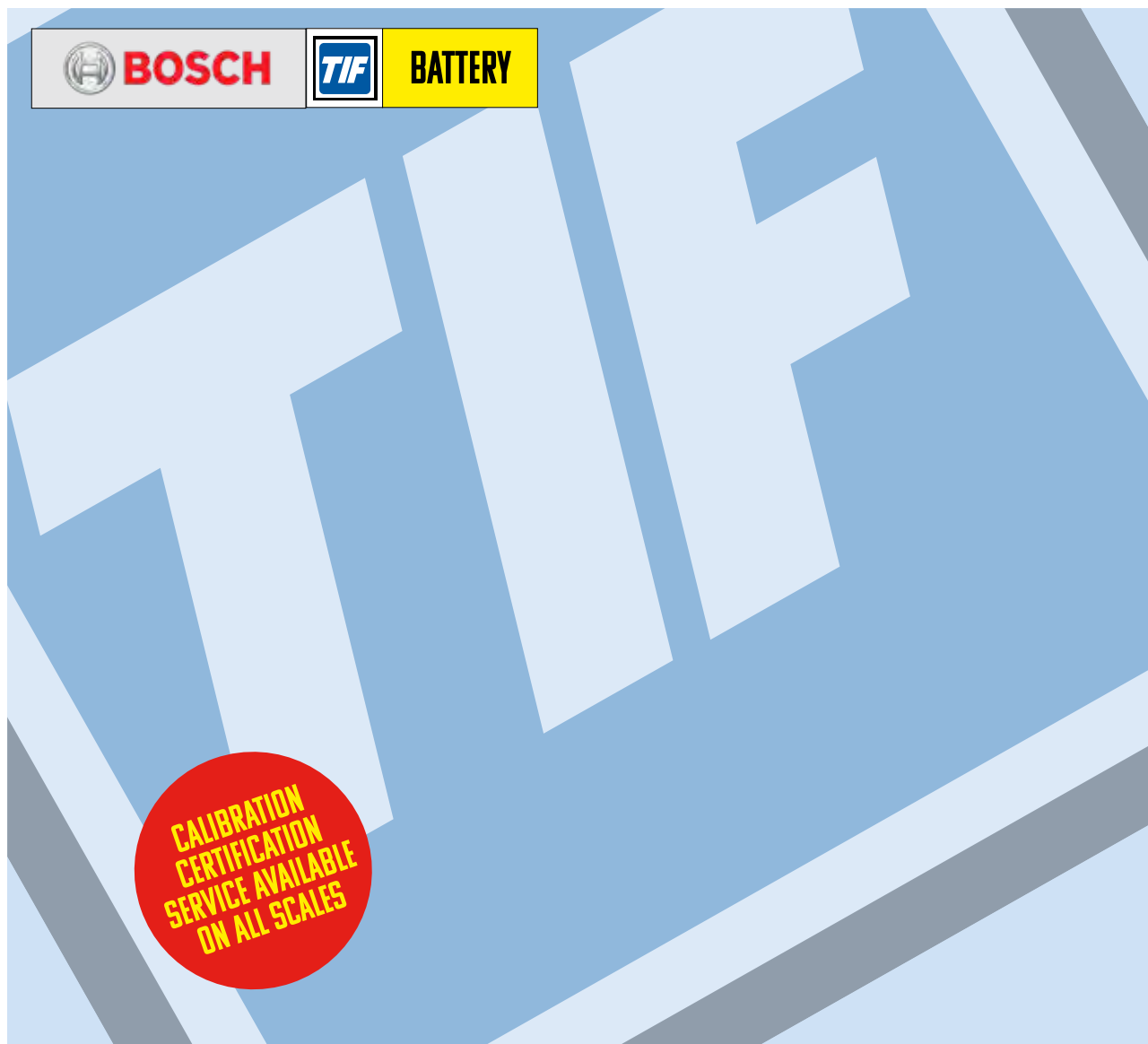

Technical information	TIF-9030E	TIF-9060S	TIF-9055
Capacity	Up to 100kg	150kg	Up to 100kg
Accuracy	± 0.5% of reading ± 1 digit	± 0.5% of reading ± 1 digit	± 0.5% of reading ± 1 digit
Resolution	10 gram	2 or 4 gram	4 gram
Platform dimensions	230mm (W) 230mm (L)	260mm (W) 270mm (L)	230mm (W) 230mm (L)
Weight	2.4kg	5.3kg	4kg
Battery type	1 x 9V alkaline battery	1 x 9V alkaline battery	1 x 9V alkaline battery and 4 x 1.5V AA batteries
Battery life	± 20 hours	± 20 hours	± 30 hours
Operating temperatures	-10°C to 49°C	-10°C to 49°C	-10°C to 45°C
Case	No	No	No
Bag	Yes	Yes	Yes

VACUUM PUMPS



A3 PUMP



3 CFM | 5 CFM | 8 CFM
RA1530-A3 | RA1550-A3 | RA1580-A3

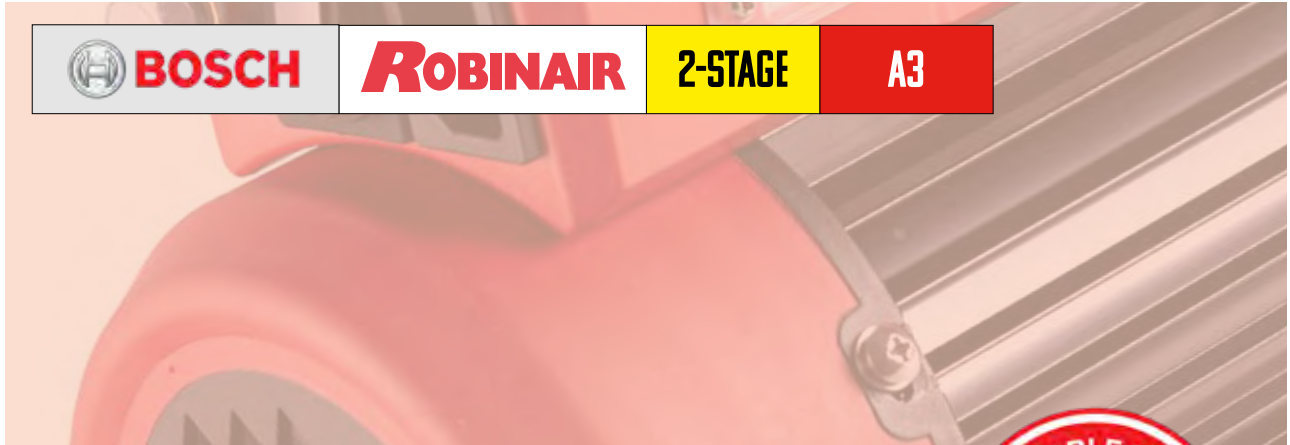

HIGH PERFORMANCE VACUUM PUMPS

The new A3 VacuMaster high performance vacuum pumps from Robinair - the quality and trusted name in vacuum pumps for over 70 years.



- Spark proof components independently tested and validated against applicable sections of ANSI 12.12.01 standard
- For use on Class A1, A2, A2L or A3 refrigerant systems
- Dual voltage, dual frequency motor for use on 120 V or 230 V, 50/60 Hz power supplies
- 2 stage design to achieve lower ultimate vacuum, as low as 15 microns
- Gas ballast valve for deeper vacuum
- Dual inlet ports (1/4" MFL and 3/8" MFL)
- Rubber lined handle, skid resistant rubber base
- Optional Exhaust Venting Kit (RA1500-A3) for use when evacuating systems running with flammable refrigerants
- One Year Warranty



LOCKING POWER CORD CONNECTION PREVENTS ACCIDENTAL DISCONNECTION OF CORD WHICH COULD CREATE A HAZARD. ONE OF SEVERAL SMALL BUT CRITICAL SAFETY FEATURES OF OUR DESIGN. **(1)** DUAL VOLTAGE AND DUAL FREQUENCY POWER SUPPLY ENSURES TRUE GLOBAL COMPATIBILITY IN ONE PRODUCT. **(2)** GAS BALLAST ENABLES FASTER ACHIEVEMENT OF HIGH ULTIMATE VACUUM LEVEL. **(3)** SEALED AND SPARK FREE COMPONENTS MEET APPLICABLE REQUIREMENTS TO ENSURE SAFE OPERATION ON A2/L AND A3 SYSTEMS. **(2)**

Part code	Description	Quantity
RA1530-A3	High performance vacuum pumps - 3CFM - A3	1
RA1550-A3	High performance vacuum pumps - 5CFM - A3	1
RA1580-A3	High performance vacuum pumps - 8CFM - A3	1

A3 PUMP



3 CFM RA1530-A3 | 5 CFM RA1550-A3 | 8 CFM RA1580-A3

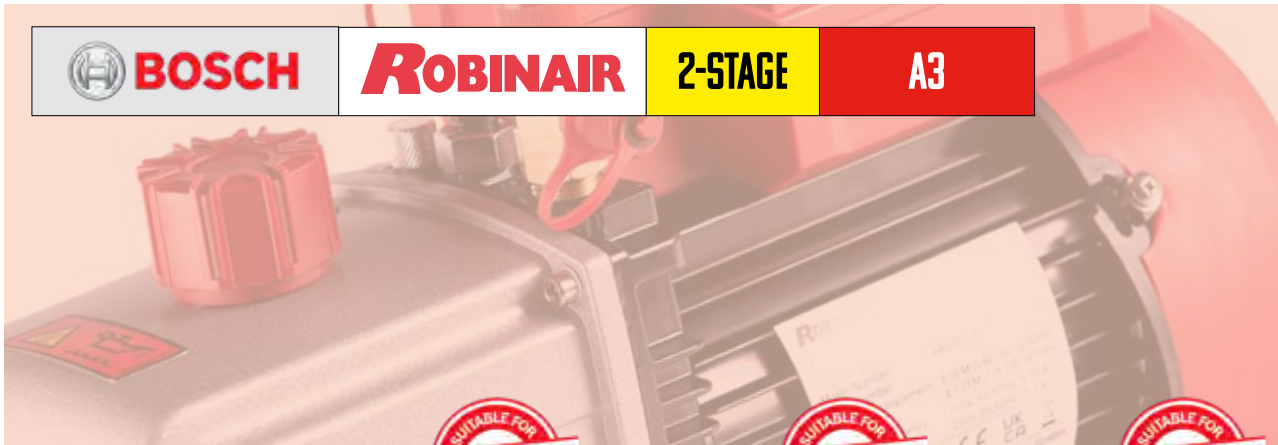

VACUUM PUMPS

BOSCH

ROBINAIR

2-STAGE

A3



	RA1530-A3	RA1550-A3	RA1580-A3
MAXIMUM CURRENT	115 V 50/60 Hz – 5,84 A 230 V 50/60 Hz – 2,84 A	115 V 50/60 Hz – 6,26 A 230 V 50/60 Hz – 3,2 A	115 V 50/60 Hz – 9,87 A 230 V 50/60 Hz – 4,75A
FREE AIR DISPLACEMENT	3 cfm (85 l/m) @60 Hz 2.5 cfm (71 l/m) @50Hz	5 cfm (142 l/m) @60 Hz 4.1 cfm (116 l/m)@50Hz	8 cfm (227 l/m) @60 Hz 6.6 cfm (187 l/m) @50Hz
ULTIMATE VACUUM	15 microns (2 Pa)	15 microns (2 Pa)	15 microns (2 Pa)
STAGES	2	2	2
MOTOR	300 watt	350 watt	660 watt
INTAKE PORTS	1/4" & 3/8" Flare	1/4" & 3/8" Flare	1/4" & 3/8" Flare
OIL CAPACITY	560ml	480ml	610ml
DIMENSIONS	348 x 140 x 272mm	348 x 140 x 272mm	382 x 160 x 285mm
WEIGHT	10.2kg	11.2kg	15.2kg

RELATED PRODUCTS



RA1500-A3 EXHAUST VENTING KIT

Designed specifically for use with Robinair VacuMaster pumps this exhaust kit allows for the routing of evacuated gases to a safe area when servicing systems that use flammable refrigerants. Length: 10 meters.

ROBINAIR PREMIUM VACUUM PUMP OIL



ROBINAIR PREMIUM HIGH VACUUM PUMP OIL

- Mineral oil
- Chemically engineered to maintain maximum viscosity at high running temperatures and to improve cold weather starts
- Thermal stability – resists break-down due to heat
- Lower moisture content – due to special packaging and handling procedures
- Performance of your pump depends largely on the quality and purity of the vacuum pump oil that you use



Part code	Description	Quantity
RA-13119	Premium High Vacuum Pump Oil, 0.475 L litres (16oz)	12
RA-13203	Premium High Vacuum Pump Oil, 0.95 Li tres (32oz)	12
RA-13204	Premium High Vacuum Pump Oil, 3.8 Litres (128.5oz)	4

ROBINAIR RA-VG-64A



DIGITAL VACUUM GAUGE

A durable self-contained battery powered vacuum gauge with LCD visual screen. Allows reading from 0 - 12,000 Microns. The unique design of the RA-VG-64A allows in-line connection through the system.

- Easy to use
- LCD visual screen
- Convenient Built-in magnetic hanger
- Sensor cleaning possible



Technical information	
Dimensions	135x75x40mm
Connections	1/4" MFL
Power supply	9V Battery
Sensor type	Thermistor
Response time	0.5 seconds
Units	Micron, psi, inHg, Millibar, Pascal, Torr, Millitorr
Battery life	Approx. 30 hours
Automatic shut-off	>10 Minutes - 12,000 Microns
Resolution	0-200 : 1 Micron 201-500 : 5 Microns 501-1000 : 10 Microns 1001-2000 : 50 Microns 2001-5000 : 250 Microns 5001-8000 : 500 Microns 8001-12000 : 1000 Microns
Accuracy	± 10 % of reading
Maximum pressure	20 bar / 300 psi
Operating temperature	2°C to 52°C

Part code	Description	Quantity
RA-VG-64-A	Digital LCD display vacuum gauge	1

CONDENSATE PUMPS AND ACCESSORIES

REDBOX-1L-S 1 LITRE CONDENSATE PUMP

The DiversiTech RedBox 1 Litre Tank Pump is a condensate tank pump with a flow rate of 280 LPH and a lift of 5.1 metres. This pump has metal mounting tabs which allows the tank to be screwed to the wall. The universal power lead makes the pump easy to install, service and retrofit.

The unique LED indicators highlight when the pump has power, is running and when the high level alarm has been activated.

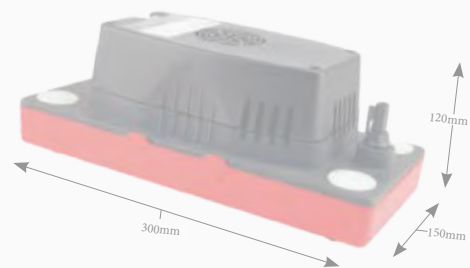

MAX. FLOW 280 LPH

TANK CAP. 1L

DECIBEL RATING 44 DB(A)

Part code	Max. lift	Discharge size	Watts	IP	Amps	Volts	HZ
REDBOX-1L-S	5.1m	3/8" / 1/4"	60W	20	1.0A	230V	50Hz

High level alarm	Inlet height fr. base	Weight	Cable length	Drink cycle	On level	Off level	Reserve before overflow	Alarm level
230V / 3A	112mm	2.3kg	1.8m	460ml	15.5mm	6mm	140ml	25mm

REDBOX-2L-S 2 LITRE CONDENSATE PUMP

The DiversiTech RedBox 2 Litre Tank Pump is a condensate tank pump with a flow rate of 280 LPH and a lift of 5.1 metres. This pump has metal mounting tabs which allows the tank to be screwed to the wall. The universal power lead makes the pump easy to install, service and retrofit.

The unique LED indicators highlight when the pump has power, is running and when the high level alarm has been activated.

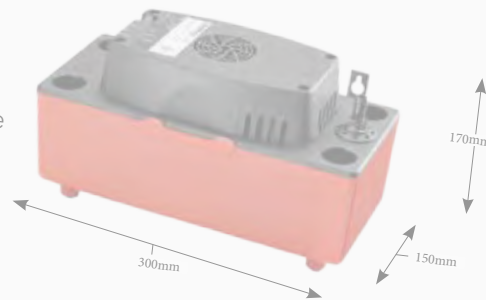

MAX. FLOW 280 LPH

TANK CAP. 2L

DECIBEL RATING 44 DB(A)

Part code	Max. lift	Discharge size	Watts	IP	Amps	Volts	HZ
REDBOX-2L-S	5.1m	3/8" / 1/4"	60W	20	1.0A	230V	50Hz

Weight	Cable length	Drink cycle	On level	Off level	Reserve before overflow	Alarm level
2.3kg	1.8m	1450ml	47mm	6.5mm	375ml	52mm

K SERIES

FIND ME ON
PAGE 16

HAND TOOLS



ROBINAIR RA-EXP-SET



HYDRAULIC TUBE EXPANDER SET

The RA-EXP-SET (tube expander set) couples hydraulic pressure with a lightweight tool to create a perfect and effortless expansion of copper, aluminium and brass pipes - with just a few pumps of the lever.

- 1/4 to 1-1/8 expander heads included in the kit
- Single-handed operation
- Laser-engraved expander heads are easy to identify and attach
- Compact design permits working in hard to access areas
- Expander heads for metric and imperial
- De-burring tool included in the kit
- Angled and ergonomic design
- 1-year warranty



Part code	Description	Quantity
RA-EXP-SET	ROBINAIR hydraulic pipe expander set with 1/4 - 1-1/8" expander heads	1
RA-EXP	ROBINAIR hydraulic pipe expander	1
RA-EXP-C-D	ROBINAIR hydraulic pipe expander with carry case	1
ADDITIONAL HEADS - NOT INCLUDED IN THE SET)		
RA-EXP-1/4	Expander head 1/4"	1
RA-EXP-3/8	Expander head 3/8"	1
RA-EXP-1/2	Expander head 1/2"	1
RA-EXP-5/8	Expander head 5/8"	1
RA-EXP-3/4	Expander head 3/4"	1
RA-EXP-7/8	Expander head 7/8"	1
RA-EXP-1-1/8	Expander head 1-1/8"	1
RA-EXP-1-3/8	Expander head 1-3/8"	1
RA-EXP-1-5/8	Expander head 1-5/8"	1
RA-EXP-DBT	Deburring tool	1

SPIN TOOLS



These flaring and swaging tools are designed for most tubing diameters, and they allow you to connect tubes without the need for extra fittings (swage), and preserves the copper malleability (flare) thus preventing cracks and leaks.



Part code	Description
FLARING TOOL SETS	
F4000	1/4, 3/8, 1/2, 5/8
F5000	1/4, 3/8, 1/2, 5/8, 3/4
F6000	1/4, 3/8, 1/2, 5/8, 3/4, 7/8
SWAGING TOOL SETS	
S4000	1/4, 3/8, 1/2, 5/8
S5000	1/4, 3/8, 1/2, 5/8, 3/4
S6000	1/4, 3/8, 1/2, 5/8, 3/4, 7/8
P3000	PLUMBING 1/2, 3/4, 1"
FLARING HEADS, INCHES	
F1014	1/4"
F1516	5/16"
F1038	3/8"
F1012	1/2"
F1058	5/8"
F1034	3/4"
F1078	7/8"

Part code	Description
SWAGING HEADS, INCHES	
S1014	1/4"
S1516	5/16"
S1038	3/8"
S1012	1/2"
S1058	5/8"
S1034	3/4"
S1078	7/8"
S6000	1/4, 3/8, 1/2, 5/8, 3/4, 7/8
P3000	PLUMBING 1/2, 3/4, 1"
FLARING TOOL SETS	
F4000	1/4, 3/8, 1/2, 5/8
F5000	1/4, 3/8, 1/2, 5/8, 3/4
F6000	1/4, 3/8, 1/2, 5/8, 3/4, 7/8
SWAGING TOOL SETS	
S4000	1/4, 3/8, 1/2, 5/8
S5000	1/4, 3/8, 1/2, 5/8, 3/4
S6000	1/4, 3/8, 1/2, 5/8, 3/4, 7/8

Part code	Description
FLARING HEADS, INCHES	
F1014	1/4"
F1516	5/16"
F1038	3/8"
F1012	1/2"
F1058	5/8"
F1034	3/4"
F1078	7/8"
SWAGING HEADS, INCHES	
S1014	1/4"
S1516	5/16"
S1038	3/8"
S1012	1/2"
S1058	5/8"
S1034	3/4"
S1078	7/8"

Part code	Description
SPIN-CASE-S	Soft Deluxe Case - swaging
SPIN-CASE-F	Soft Deluxe Case - flaring
SPIN-X6000	Swaging / flaring tool set - 1/4", 3/8" & 1/2" in soft case

TUBE CUTTERS - METAL TUBING



HI-DUTY TUBE CUTTERS

FOR 1/8" TO 1-1/8" AND 1/4" TO 1-5/8" O.D. TUBING.



TC-1000

TC-1000

For 1/8" to 1-1/8" (4 mm to 28 mm) O.D. tubing. Includes (2) S75015 general purpose cutter wheels. Length 5". Wt. 8.8 oz.

TC-1010

For 1/8" to 1-1/8" (4 mm to 28 mm) O.D. tubing. Includes (2) S75046 cutter wheels for continuous cutting of stainless steel, monel and other hard-temper tubing. Length 5". Wt. 8.8 oz.

312-FC

For 1/4" to 1-5/8" (7 mm to 41 mm) O.D. tubing. Includes (2) S75015 general purpose cutter wheels. Length 5-1/2". Wt. 10.4 oz.



TC-1010



312-FC

SPARES

S75015

General purpose cutter wheel.

S16003162

Replacement cutter wheel for soft copper & aluminum tubing is extra sharp to minimize burr buildup.

S75046

Wheel for continuous cutting of stainless steel, monel and other hard temper tubing. For cutters TC-1000, TC-1010, TC-1550, TC-1560, 312-FC, 174-F, TC-2050 and TC-3050.

S76637

Constrictor wheel for producing sweat joints.

FLARE CUT-OFF GROOVE
Groove in rollers reduces tube loss when cracked flare is removed.

FOLDAWAY REAMER
Hardened steel reamer with turned cutting edge removes inside burrs cleanly. Filing surface removes outside burrs.

SPARE CUTTING WHEEL
Spare cutter wheel carried under foldaway locking reamer.

TC-1020 TUBE CONSTRICTOR
FILL WITH SOLDER
Joint is ready for sweating when constricted tube contacts smaller tube. Can be used for crimping applications.

IMP MINI TUBE CUTTERS

FOR 1/8" TO 5/8", 3/16" TO 7/8" AND 1/8" TO 1-1/8" O.D. TUBING.

- Big capacity, small size tube cutters designed for use in tight quarters where other cutters won't fit
- Enclosed feed screw minimizes contamination assuring continued smooth operation
- Corrosion-resistant steel rollers positioned at bottom of cutter allow for easier cutter engagement on tubing and smoother cutting action
- All Imperial® tube cutters are 100% factory tested to ensure accurate spiral-free cutting



TC-1050

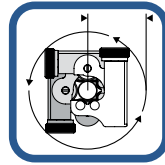

Swing Radius



TC-2050

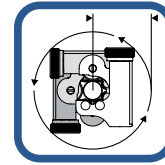

Swing Radius

TC-1050

For 1/8" to 5/8" (4 mm to 15 mm) O.D. tubing. Includes (1) S32633 general purpose cutter wheel. Swing radius 1-1/4" (1-3/8" swing radius with 5/8" tube). Length 1-3/4". Wt. 2.5 oz.

S32633

General purpose cutter wheel for TC-1050.

S26883

Screw for TC-1050 cutter wheel.

TC-2050

For 3/16" to 7/8" (5 mm to 22 mm) O.D. tubing. Includes (1) S75015 general purpose cutter wheel. Swing radius 1-11/16". Length 2-1/4". Wt. 4.0 oz.

S75015

General purpose cutter wheel.

RATCHETING TUBE CUTTERS

FOR 1/8" TO 5/8" AND 1/8" TO 1-1/8" O.D. TUBING.

- Easily completes a full revolution, maximizing leverage
- Cutter can easily be removed from the handle
- Ergonomic handle with non-slip grip
- Six independent drive pawls provide 15° arc-swing
- Includes (1) general purpose cutter wheel



TC-1050RH

TC-1050RH

For 1/8" to 5/8" (4 mm to 15 mm) O.D. tubing. 2-Pc. set includes TC-1050 "IMP"® mini tube cutter and ratcheting handle in clamshell packaging. Length 5". Wt. 6.0 oz.

TC-1051

Ratcheting handle only. Length 5". Wt. 1.5 oz.



BIG IMP TUBE CUTTER

FOR 3/8" TO 1-1/8" (10 MM TO 28 MM) O.D. TUBING.

174-F

Includes (2) S75015 general purpose cutter wheels. Swing radius 1-15/16" (2-1/4" swing radius with 1-1/8" tube). Length 2-11/16". Wt. 5.0 oz.

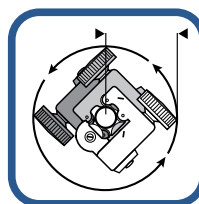

Swing Radius
1-15/16"



TUBE CUTTERS - METAL TUBING



ADJUST-O-MATIC TUBE CUTTERS

FOR 3/8" TO 2-5/8" AND 2" TO 4-1/8" O.D. TUBING.

- Ratchet feed mechanism speeds up cutting operation
- Extra wide rollers with flare cut-off groove stabilize tubing
- Spare cutting wheel included under handle cap
- Enclosed screw-type feed mechanism; lightweight aluminum alloy body

406-FA



206-FB

For 3/8" to 2-5/8" (10 mm to 66 mm) O.D. tubing. Includes (2) S74761 general purpose cutter wheels. Length closed 7-3/4". Wt. 2.0 lbs.

406-FA

For 2" to 4-1/8" (51 mm to 104 mm) O.D. tubing. Includes (2) S74833 general purpose cutter wheels. Length closed 11-1/4". Wt. 3.5 lbs.

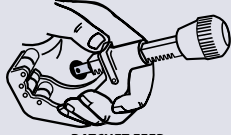
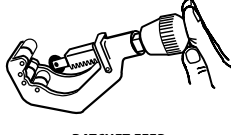
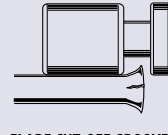
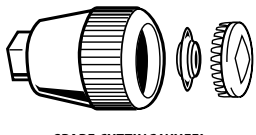
 <p>RATCHET FEED Ratchet release opens cutter instantly to maximum size.</p>	 <p>RATCHET FEED Push on handle to slide cutter wheel to tubing. Rotate handle for fine adjustment.</p>	 <p>FLARE CUT-OFF GROOVE Wide flare cut-off groove in rollers to accommodate flares on large size tubing.</p>	 <p>SPARE CUTTING WHEEL Spare cutter wheel included in handle under snap-off cap.</p>
--	---	--	---

144-F IMPERIAL® TUBE CUTTER SERVICE CENTER

FOR 1/8" TO 4-1/8" O.D. TUBING.

Selling Imperial® replacement cutter wheels, reamer blades and fasteners is easy. Our Service Center organizes a popular selection of replacement parts for Imperial cutters. Display on the counter or bring it with you when making sales calls.

- 15 most common replacement parts stocked in one handy container
- Includes a visual replacement chart for quick and easy identification



Part code	QTY	Description	Cutter
S74761	5	Cutter wheel	206-FB, 206-FBP
S74762	5	Cutter Wheel Retaining Screw	TC-1000, TC-1010, 312-FC, 174-F, TC-2050, TC-3050
S74833	3	Cutter Wheel	406-FA
S77511	3	Cutter Wheel Retaining Screw	206-FB, 206-FBP
S74834	3	Cutter Wheel Retaining Screw	406-FA
S10000770	3	Cutter Wheel for PVC	206-FB, 206-FBP
S7931801	3	Reamer blade	TC-1000, TC-1010, 312-FC
S8201501	3	Retaining screw for reamer blade	TC-1000, TC-1010, 312-FC
S74197	3	Spring washer for reamer blade	TC-1000, TC-1010, 312-FC
144-FB	1	Container only	-

SPRING TYPE TUBE BENDERS

**FOR SOFT COPPER AND ALUMINUM TUBING.
FOR 1/4" TO 7/8" O.D. TUBING.**

Tools allow hand bending of soft tubing to any shape without collapsing walls. Special spring steel, zinc finish. End belled for quick tube removal.

163-F

Set of 4 benders for 1/4", 3/8", 1/2" and 5/8" O.D. tubing.



Part code	TUBE O.D. (in.)	LENGTH (in.)	WEIGHT EACH (OZ.)
102-F-04	1/4	10	3
102-F-05	5/16	10	3
102-F-08	1/2	12	6.5
102-F-10	5/8	12	8
102-F-12	3/4	12	10
102-F-14	7/8	12	10

Each tool bends only one size.

OIL PUMPS & ADAPTERS KITS

CHARGE-OIL PUMP



It charges without pumping the compressor down thus reducing charging time by over 70%. Also avoids the embarrassment of spilling oil on the customer's premises. Provides the professional touch since oil can be accurately measured into the compressor without having to pour it from the can. Fits all popular brands of refrigeration oil.

Complete Adapter Kit supplied to accommodate most containers. The Charge-Oil Pump cap seals the can so pump need not be removed until can is empty. The piston type high pressure pump is designed to operate at pressures to 250 PSI. Pumps one quart in 20 full strokes of the piston. Pump is connected to compressor by refrigerant charging line or copper tubing from 1/4" male fitting. Suitable for use with alkybenzene and POE oils.

Part code	Description
1702	Charge oil pump

TUBE BENDERS

470-FH TRIPLE HEAD 180° TUBE BENDER WITH ROTO-LOK INDEXING HANDLE

- Bends 3/16", 1/4", 5/16" and 3/8" O.D. tubing.
- Patented, quick-action indexing lever repositions two-stage handle midway through bend when both handles begin to meet. This feature allows easy fabrication of bends up to 180° with reduced effort, better control and no crossing of handles!
- Optimum bending radius – for each tubing size.
- Calibrated markings – for making accurate left-hand, right-hand and offset bends.
- Compact design for working in tight spaces.
- Cushion grips – for comfort and stability.
- Made of lightweight, die-cast aluminum.



TUBE O.D. (in.)	RADIUS TO CENTER OF TUBE (in.)
3/16	9/16
1/4	9/16
5/16	11/16
3/8	15/16

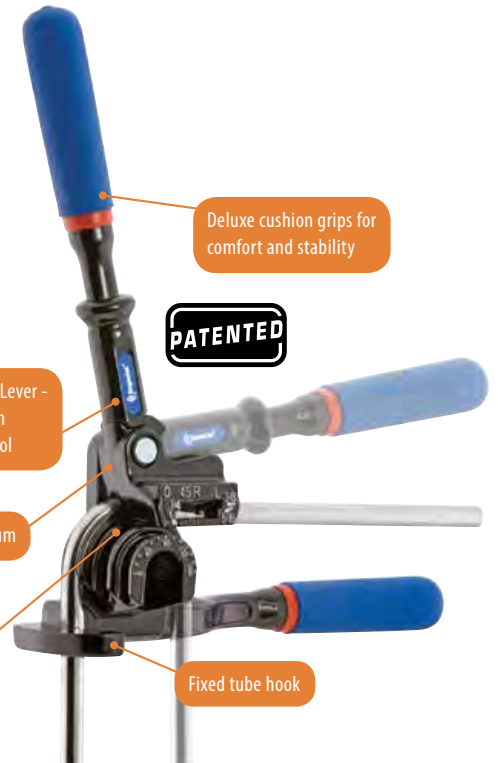

370-FH TRIPLE HEAD 180° TUBE BENDER

- Bends 3/16", 1/4", 3/8" and 1/2" tubing
- Makes smooth, tight-radius 180° bends
- Calibrated markings - for making accurate left-hand, right-hand and offset bends
- Adjustable hook
- Optimum bending radius - for each tubing size
- Cushion grips - for extreme comfort
- Made of lightweight die-cast aluminum



TUBE O.D. (in.)	RADIUS TO CENTER OF TUBE (in.)
3/16	11/16
1/4	11/16
3/8	1-1/8
1/2	1-1/2

IMP TRIPLE HEAD BENDERS

- Bends soft copper, aluminum and thin wall steel tubing
- Bends 1/8", 3/16", 1/4", 5/16", and 3/8" tubing
- Makes smooth, tight-radius 90° bends
- Calibrated markings - for making accurate left-hand, right-hand and offset bends
- 90° start requires less effort – making bending fast and easy
- Made of lightweight die-cast aluminum



367-FH

For 1/8", 3/16" and 1/4" (3 mm, 4 mm and 6 mm) O.D. tubing. Wt. 0.5 lbs.

TUBE O.D. (in.)	RADIUS TO CENTER OF TUBE	
	INCH	MM
1/8	5/8	16
3/16	19/32	15
1/4	9/16	14

368-FH

For 3/16", 1/4", 5/16" and 3/8" (6 mm and 8 mm) O.D. tubing. Wt. 1.0 lbs.

TUBE O.D. (in.)	RADIUS TO CENTER OF TUBE	
	INCH	MM
3/16	1-1/64	26
1/4	1-1/64	26
5/16	1	25
3/8	15/16	24

LEVER/SWIVEL TUBE BENDERS

364-FHA LEVER TYPE TUBE BENDERS

FOR 1/8" TO 1" AND 6 MM TO 12 MM O.D. TUBING.

Each tool bends one size. Open-side type which slips over tube at any point. Makes smooth, tight radius bends up to 180° with minimum effort. No scoring or flattening of tubing. Calibrated to show angle of bend. Wide hook grips tubing securely.

Part code	TUBE O.D. (in)	RADIUS to centre of tube (in)	WEIGHT EACH (lbs)
364-FHA-04	1/4	10	3
364-FHA-05	5/16	10	3
364-FHA-06	3/8	10	4
364-FHA-08	1/2	12	6.5
364-FHA-10*	5/8	12	8
364-FHA-12*	3/4	12	10
364-FHA-14*	7/8	12	10

Each tool bends only one size.

Conforms to Federal Specification GGG-B-191a Type III, Class 2.

* For bending annealed copper and aluminum tubing only.



METRIC SIZE

Part code	TUBE O.D. (mm)	RADIUS to centre of tube		WEIGHT EACH	
		mm	inches	kg	lbs
364-FHAM-10MM	10	24	15/16	0.79	1.75

Each tool bends only one size.

364-FHB SWIVEL HANDLE TUBE BENDERS

FOR 1/4" TO 1/2" AND 6 MM TO 12 MM O.D. TUBING.

The 364-FHB series has a swivel handle that can be repositioned midway through a bend when both handles begin to meet. This simple feature allows easy fabrication of bends up to 180° with reduced effort, better control and without the crossing of handles, typical of most other lever type benders.

Part code	TUBE O.D. (in)	RADIUS to centre of tube (in)	WEIGHT EACH (lbs)
364-FHB-06	3/8	15/16	1.75
364-FHB-08	1/2	1-1/2	3.5

Each tool bends only one size.

Conforms to Federal Specification GGG-B-191a Type III, Class 2.



GRABBER ROL-AIR 45° FLARING TOOL

UNIVERSAL APPLICATION. ADJUSTABLE OPENING HOLDS ALL SIZES. FLARES AND BURNISHES 3/16" TO 5/8" (4.75 MM TO 16 MM) O.D. TUBING.

525-F

Unique, self-adjusting, tube holding mechanism permits flaring any size tubing within the range of 3/16" to 5/8" (4.75 mm to 16 mm) O.D. Innovative, single-opening design is more compact and easier to use than conventional multi-opening flaring bars. Faceted, hardened steel, chrome finished cone rolls out and burnishes perfect 45° flare above the tube-holding mechanism reducing need for deburring. Original wall thickness is maintained at base of flare. Slip-on self-centering yoke permits use in tight quarters. Large handle, with better leverage, and precision threads on feed screw make flaring effortless. High quality construction with satin chrome and black finish. Wt. 1.75 lbs.



Outside Tube Diameter	(in.)	3/16	1/4	5/16	3/8	1/2	5/8
Wall Thickness	(in.)	.028	.035	.035	.035	.035	.035

Outside Tube Diameter	(mm)	4.75	6	8	10	12	15	16
Wall Thickness	(mm)	1.0	1.0	1.0	1.0	1.0	1.0	1.0

45° FLARING TOOL

FOR 3/16", 1/4", 5/16", 3/8", 1/2" AND 5/8" O.D. TUBING.

437-FB

For use with soft copper, aluminum and brass tubing. Hardened steel, chrome finished cone makes exceptionally smooth, high-strength flares with a radius at base of flare – instead of the sharp angle formed by ordinary tools. Slip-on yoke permits use in tight quarters, allows flaring where there is little space between nut and tube end. New feed screw design provides smooth, easier operation. Positive gripping and self-gauging of tube for exact flare size. Sliding die blocks lock in place by clamp action. Satin chrome and black finish. Wt. 1.75 lbs.



Outside Tube Diameter	(in.)	3/16	1/4	5/16	3/8	1/2	5/8
Wall Thickness	(in.)	.032	.032	.032	.032	.035	.035

45° FLARING TOOL

FOR 3/16", 1/4", 5/16", 3/8", 7/16", 1/2" AND 5/8" O.D. TUBING.

195-FC

Flares 7 sizes of tubing. Rugged forged steel slip-on yoke and hardened flaring bar. Positive clamping action of bars prevents tube slippage. Self-centering yoke with swivel-type, hardened steel, chrome finished flaring cone forms better flares with less effort. Design of yoke permits flaring where there is little space between nut and tube end. Satin finish nickel chrome plated. Wt. 2.0 lbs.



Outside Tube Diameter	(in.)	3/16	1/4	5/16	3/8	7/16	1/2	5/8
Wall Thickness	(in.)	.028	.035	.035	.035	.035	.035	.035

FLARING AND SWAGING



45° LARGE SIZE FLARING TOOL

Flares larger tube sizes. Quick slip-on yoke with hardened steel, chrome finished swivel flaring cone reduces effort. Positive clamping action of flaring bar eliminates tube movement. Nickel chrome finish.



203-FA

For sizes 5/8", 3/4", 7/8" and 1-1/8" O.D. tubing. Wt. 3.75 lbs.

375-FS

For sizes 1/8", 3/16", 1/4", 5/16", 3/8", 7/16", 1/2", 5/8" and 3/4" O.D. tubing. Includes tool case. Wt. 3.75 lbs.

Outside Tube Diameter	(in.)	1/8	3/16	1/4	5/16	3/8	7/16	1/2	5/8	3/4	7/8	1	1-1/8
Wall Thickness	(in.)	.025	.028	.035	.035	.035	.035	.035	.049	.049	.049	.058	.058

45° ROL-AIR FLARING TOOLS

FLARES AND BURNISHES 3/16", 1/4", 5/16", 3/8", 1/2" AND 5/8" O.D. TUBING.

500-FC

Faceted, hardened steel, chrome finished cone rolls out perfect 45° flares above die block, and automatically burnishes flare face reducing the need for deburring. Original wall thickness is maintained at base of flare. Slip-on yoke permits use in tight quarters, where there is little space between nut and tube end. Larger handle, with better leverage, and precision threads on feed screw make flaring effortless. Heat treated dies grip tubing without scoring. Satin chrome and black finish. Wt. 1.5 lbs.



Outside Tube Diameter	(in.)	3/16	1/4	5/16	3/8	1/2	5/8
Wall Thickness	(in.)	.028	.035	.035	.035	.035	.035

FLARING (45°) AND SWAGING TOOL

FOR 1/8" TO 3/4" O.D. TUBING.

275-FS

Flares and swages. Converts quickly. Screw-type feed. Ideal for use in close quarters. Two bars included cover 9 sizes. Swivel-type swaging adapters and flaring cone are hardened steel, chrome finished for easy operation. Self-centering, slip-on forged steel yoke. Includes tool case. Wt. 3.5 lbs. Flares 1/8", 3/16", 1/4", 5/16", 3/8", 7/16", 1/2", 5/8" and 3/4" O.D. Includes 5 swage adapters for 7 tube sizes: 3/16", 1/4", 5/16", 3/8", 1/2", 5/8", 3/4" O.D.



REPLACEMENT PARTS

- 278-FS-03X04X06** Adaptor 3/16", 1/4", 3/8".
- 278-FS-05** Adaptor 5/16"
- 278-FS-08** Adaptor 1/2"
- 278-FS-10** Adaptor 5/8"
- 278-FS-12** Adaptor 3/4"
- S38600** Flaring cone

Outside Tube Diameter	(in.)	1/8	3/16	1/4	5/16	3/8	7/16	1/2	5/8	3/4
Wall Thickness	(in.)	.020	.028	.035	.035	.035	.035	.035	.035	.035

INNER-OUTER REAMING AND DEBURRING TOOL

FOR 3/16" TO 1-1/2" (5 MM TO 38 MM) O.D. TUBING.

Reams both inside and outside edges of tube at a 60° included angle with 3 hardened cutting blades. Tough die cast body. Deburrs both clockwise and counterclockwise. Fluted body is shaped to fit comfortably in palm.



208-F

Reamer for copper, aluminium and brass tubing. Hardened steel cutter blades. Blue finish. Wt. .63 lbs.

208-FSS

Reamer for aircraft grade stainless steel tubing, hard or soft copper, aluminium, brass and steel tubing. Tungsten hardened tool steel cutter blades. Black finish. Wt. .63 lbs.

TOOL BAGS

15-POCKET PROFESSIONAL TOOL BAG

TB-52

- 8" W x 16" L x 11" D.
- Double layered ballistic nylon.
- Wide opening mouth.
- Padded handles and 48" shoulder strap.
- Designed to hold tools.
- Tools not included!



ADAPTORS

HOSE SHUT-OFF ADAPTORS

The Kwik-Coupler® adapter set is intended for use with refrigeration and air-conditioning service hoses when connecting to core valve type access fittings. Conventional threaded connecting is converted to push-pull operation which is faster, easier and positive sealing at all times. Valve cores are depressed automatically without adjustments or loss of refrigerant. Disconnecting is also accomplished without loss of refrigerant.

An automatic shut-off valve retains refrigerant pressure in a disconnected hose. This feature permits transferring high side hose refrigerant through the service manifold into the low side, thereby eliminating waste and hazardous high pressure discharge and atmospheric damage.



16-C

Straight Coupler (45° Flare) 1/4" female x 1/4" male.

17-C

90° Elbow Coupler (45° Flare) 1/4" female x 1/4" male.

18-C

(Set) includes 16-C and 17-C.

26-C

Straight Coupler (45° Flare) 5/16" female x 5/16" male.

27-C

90° Elbow Coupler (45° Flare) 5/16" female x 5/16" male. 26-C and 27-C.

TESTING AND SERVICE TOOLS



PINCH-OFF TOOL

FOR 1/4" TO 1/2" O.D. TUBING.

Temporarily closes soft copper, aluminum or steel tubing so no liquid or gas passes sealed part. Lets you disconnect line while making repairs without loss of liquid or gas. Forming holes for 1/4", 5/16", 3/8" and 1/2" O.D. tubing.

105-FF

Pinch-Off Tool for 1/4", 5/16", 3/8" and 1/2" O.D. tubing. Wt. .75 lbs.



WRENCHES

WRENCHES

FOR REFRIGERATION AND AIR CONDITIONING SERVICE.

127-C

Compressor access valve wrench. Chrome plated. Has 1/4", 3/8", 3/16" and 5/16" square drive ratchets and is specially designed for use on compressors with access valves in hard to reach places. Reversible ratchets.

127-CO

Same as 127-C except with unique 25° offset that provides additional convenience in hard to reach places.

124-C

Combination wrench with the four sizes most needed for servicing air-conditioning and refrigerator equipment:

- 9/16" hex for dust cap on access valves and plug oil check on compressor.
- 1/2" hex for compressor mounting bolts.
- 1/4" square for valve stem and service valves and old style compressor valves.
- 3/16" square for valve refrigerant charging tanks.



TUBE DEBURRING

DEBURRING TOOL

210-F

The rotary style blade is perfect for removing burrs from holes and edges. Large ergonomic handle reduces user fatigue. Ships complete with two heavy duty blades - extra blade stores inside the handle. For copper, steel, aluminum, zinc, cast iron, brass and plastic tubing. Length 5-3/4". Wt. 1.5 oz.



KWIK CHARGE

LIQUID LOW SIDE CHARGER PROVIDES FAST, SAFE CHARGE - ESSENTIAL FOR TODAY'S BLENDED REFRIGERANTS!



The Kwik Charge® charging unit accepts liquid refrigerant from the cylinder and discharges into low side of the system. Charging rate is up to eight times faster than vapor charging. In addition, liquid charging is required when using R-410A and other blended refrigerants. Attach the Kwik Charge device to the low side of the charging manifold. Charging hose is connected from Kwik Charge device outlet to low side of refrigeration system. Internal metering element reduces liquid flow to a level below capacity of compressor. This assures a safe, fast charge without endangering the compressor. A built-in ball check valve automatically opens when drawing a vacuum to assure rapid, unrestricted evacuation. Can be used with all fluorinated hydrocarbon refrigerant systems.

- Up to 8 times faster than vapor charging.
- No need to heat refrigerant cylinder.
- Built-in check valve opens for drawing unrestricted vacuum.
- No pressure drop in cylinder.
- One charger services all units 1/2 ton or larger.

535-C

Kwik Charge® charging unit 1/4" female SAE flare inlet, 1/4" male SAE flare outlet.

AIR SOURCE HEAT PUMPS

WHETHER IT'S INSTALLING, CONNECTING, INSULATING, PROTECTING OR MAINTAINING... WE HAVE YOU COVERED!

#THEDIVERSITECHWAY

ARE YOU GETTING 100% OF HEAT FROM YOUR AIR SOURCE HEAT PUMP INSTALL INTO YOUR PROPERTY? SEE PAGE 93 FOR MORE DETAILS ...

KWIK-COUPLER REPAIR KITS

KWIK COUPLER REPAIR KITS

The Kwik-Coupler® adapter repair kit is intended for use with Imperial® brand 16-C, 17-C, 18-C and 19-C Kwik-Coupler® adapters and PolarShield® KC-Series hose. The male repair kit includes a threaded hex sleeve for replacement on straight coupler assemblies.

KCK-M MALE KWIK COUPLER ADAPTOR REPAIR KIT REPAIRS 2 MALE COUPLERS

INCLUDES: HEX SLEEVE (2), SPRING (2), STEM ASSEMBLY (2) AND SEALANT

REPAIR INSTRUCTIONS

1. Remove threaded sleeve on end of Kwik-Coupler® adapter. A vise may be necessary to remove old straight sleeve - the 90° has a screwdriver slot on back for removal.
2. Discard old stem and spring.
3. Use a wire brush to clean sealant residue from disassembled parts.
4. Insert new stem and spring.
5. Apply one bead of thread sealant completely around the thread. Do not apply an excessive amount of sealant - this may damage o-ring seal and cause leakage.
Assemble to length at right (Fig. 1 & 2). For 90° style, engage threads until the bottom of the slot is even with the back of the coupler (Fig. 4).
6. Allow sealant to cure at least 30 minutes. The Kwik-Coupler® adapter is now ready to use.

KCK-F FEMALE KWIK COUPLER ADAPTOR REPAIR KIT REPAIRS 5 STANDARD AND 5 AUTOMOTIVE FEMALE COUPLERS (NOT FOR 26-C AND 27-C)

INCLUDES: RETAINER (2), GASKET (5), O-RING (10) AND O-RING 3/16" FOR AUTOMOTIVE (5)

REPAIR INSTRUCTIONS

1. Insert tapered object (pen or pencil) and press against threaded retainer. Unscrew and remove retainer, sleeve and rubber seals.
2. Lubricate new seals and reassemble. Tighten retainer to zero clearance plus 1/8" turn. The Kwik-Coupler® adapter is now ready for use.

Part code	Description	Used on
S8920071	Female Coupler 1/4" & 3/16"-Sleeve	16-C, 17-C, 18-C, 19-C
S8920072	Female Coupler 1/4" & 3/16"-Retainer	16-C, 17-C, 18-C, 19-C
S8920073	Female Coupler 1/4"-Gasket	16-C, 17-C, 18-C, 19-C
S8920074	Female Coupler 1/4"-Low Side	16-C, 17-C, 18-C, 19-C
S8920077	Female Coupler 1/4", 3/16" & 5/16"-O-Ring	16-C, 17-C, 18-C, 19-C
S8920263	Female Coupler 3/16" -O-Ring	19-C
S5951125	Female Coupler 1/4" for Non-Core Valve	16-C, 17-C, 18-C, 19-C
KCK-F	Repair Kit For All Female Couplers	
KCK-M	Repair Kit For All Male Couplers	

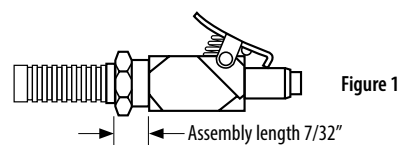

Figure 1

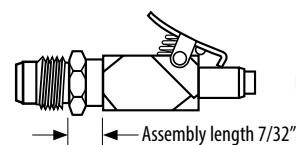
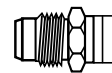
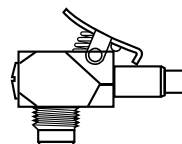
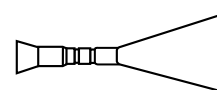
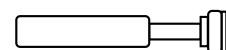
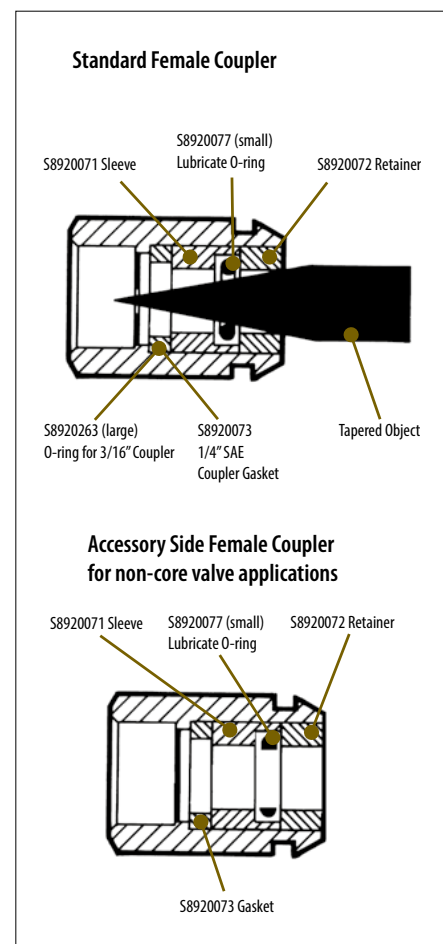

Figure 2

Figure 3
Hex sleeveFigure 4
90° assemblyFigure 5
SealantFigure 6
SpringFigure 7
Stem assembly

COIL JET 125

Portable power for the inside and out. The CoilJet from SpeedClean makes quick work of cleaning debris and grime from condenser and evaporator coils. Now deliver professional results in a convenient and rechargeable battery powered solution – no more garden hoses or pump sprays needed.

The CoilJet delivers a powerful spray of water and cleaning chemical from the included tanks to wash even the dirtiest coils, without damaging sensitive fins. And the small portable size lets you clean coils from the front or back of the coil – a proven method for increasing coil cleaning and system efficiency. CoilJet makes cleaning coils quick and easy. Now that's smart.



- Portable and rechargeable. Clean coils in hard to reach areas such as rooftops and attics where access to power and water is limited.
- Powerful 125 PSI (8,6 BAR) spray cleans debris and grime without damaging fins.
- Optional spray wand with 90° nozzle lets you clean from the inside out. Forces dirt and debris back in the direction it entered.
- Deep cycle, 12 V rechargeable battery lasts all day.
- Includes: CoilJet System, 2 standard spray nozzles, rechargeable battery, and AC charger.

Part code	CJ-125
Dimensions (H x W x D)	48.3 cm x 25.4 cm x 45.7 cm 9" x 10" x 18"
Weight	10 kg / 22 lbs (net dry); 23.6 kg / 52 lbs (chemical & water)
Capacity (water)	12.8 L / 3.3 gal.
Capacity (chemical)	1.7 L / 1.7 qt.
Pump	Positive displacement diaphragm
Output Pressure	125 PSI (8,6 BAR)
Output Water Supply	2.3 LPM / 0.7 GPM
Input Power	15 amps, 12V, DC (deep cycle) rechargeable VRLA battery
General Warranty	1 year
Patent	9,266,152



LINE SET BENDER

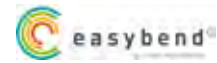

EASYBEND - AIRCO LINE SET BENDER

The "easy" soft copper bend!

Easybend is designed specifically for use as an internal pipe bender to offer the installer a fast, easy and kink and leak-free bend in soft copper linesets. Reusable - just clean it off after use and store in the zip lock bag.



- Bends linesets when installing split systems
- Easiest way to bend twin tubes without damaging their insulation
- Reusable
- No need for springs or heavy equipment
- Only for soft copper

THE PACKAGE

- Red line 
- Green line 
- Yellow line 
- Blue line 

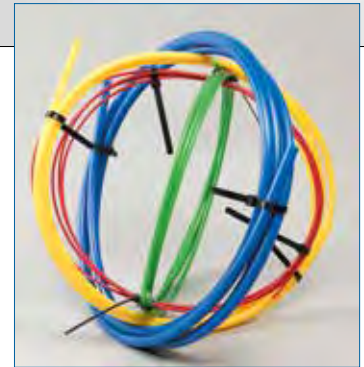

FAST AND EASY INSTALLATION



STEP 1
INSERT THE FLEXIBLE BENDER OF THE RIGHT DIAMETER INTO THE COPPER TUBE.



STEP 2
BEND TO THE REQUIRED ANGLE.



STEP 3
RETRACT THE FLEXIBLE BENDER.



STEP 4
THESE BENDERS ARE REUSABLE IF WIPED CLEAN BETWEEN INSTALLATIONS.



HOW NOT TO USE!

Part code	Colour	Diameter	Length	Qty
EZB (4 colours per set)	Red	6mm (1/4")	4m (13')	15 sets per box
	Green	9mm (3/8")	4m (13')	15 sets per box
	Yellow	12mm (1/2")	4m (13')	15 sets per box
	Blue	16mm (5/8")	4m (13')	15 sets per box

MANIFOLDS



CO2 MANIFOLDS

RA 411744E300C

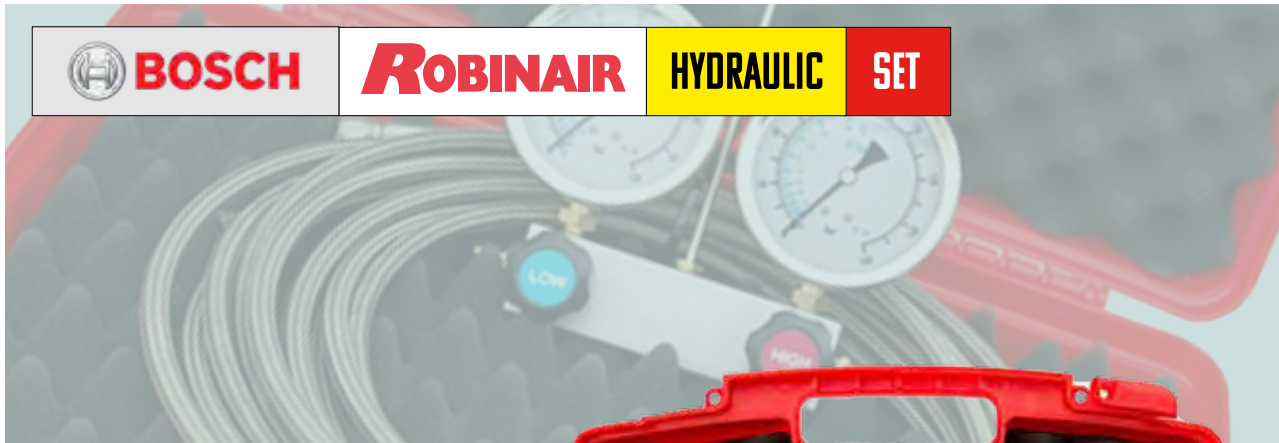

2-WAY MANIFOLD

- 2-Way Manifold
- Available separately or as Set with hoses and carrying case
- Analog gauges ø 80 mm, oil filled, metal casing
- High pressure gauge 1 to 160 bar
- Low pressure gauge -1 to 100 bar
- Hose lenght 3 m
- Hose connection 1/4" SAE (7/16" UNF)
- PTFE hoses with stainless steel braid
- Working pressure 224 bar (-70 to 230 °C)
- Burst pressure 672 bar



Code	Description	Quantity
RA 411744E300C	Robinair 2-way manifold	1

IMPERIAL - HVAC&R SERVICE MANIFOLDS

Imperial deluxe service manifolds have rugged lightweight bodies, with laser-etched graphics. A proven diaphragm valve design allows finger-touch operation, with just one turn to fully open. Imperial gauges are non-flutter, with high visibility faceplates. Our manifolds also feature large knobs with a soft-touch grip surface. All spare parts are readily available.

DELUXE 4-VALVE

- The 3/8" vacuum port and oversized internal passages allow for 4-times faster evacuation than conventional manifolds
- Deep vacuum diaphragm-type soft-seat valves require only fingertip pressure to close completely or open for full-flow
- Precision class I 80mm gauges provide superior resistance to vibration and pulsation for accurate performance and extended gauge life
- PolarShield® Hi-Performance Hoses (800 PSI/WP, 4,000 PSI/BP) - not all models include hose



Manifold only	36" hoses	60" hoses	72" hoses	Description
IMP-840C-PH	IMP-840C-36-PH	IMP-840C-60-PH	IMP-840C-72-PH	No Sight Glass, 80mm Gauges, Blue Body R410A, R32
IMP-848C-PH	IMP-848C-36-PH	IMP-848C-60-PH	IMP-848C-72-PH	No Sight Glass. 80mm Gauges, Blue Body R134A,R404A,R407C
IMP-849C-PH	IMP-849C-36-PH	IMP-849C-60-PH	IMP-849C-72-PH	No Sight Glass, 80mm Gauges, Blue Body R448A,R449A,R452C

DELUXE 2-VALVE, 4 & 5 PORT

- Precision engineering with dyna1nic full-flow valve design for faster evacuation and charging
- Dual O-ring valve seals for long-life and trouble-free performance
- Precision gauges provide superior resistance to vibration and pulsation for accurate performance and extended gauge life
- Protective gauge boots shield against shock and vibration
- Ergonomic colour-Part coded soft-touch handles.
- PolarShield® Hi-Performance Hoses (800 PSI/WP, 4,000 PSI/BP) - not all models include hose.



(MODEL SHOWN - IMP-560CB) WITHOUT HOOK

Manifold only	36" hoses	60" hoses	72" hoses	Description
IMP-540CB	IMP-540CB-36-PH	IMP-540CB-60-PH	IMP-540CB-72-PH	No Sight Glass. 4 Port 63mm Gauges. Silver Body (with Rubber Boots) R41 O A/R32
IMP-560CB	IMP-560CB-36-PH	IMP-560CB-60-PH	IMP-560CB-72-PH	With Sight Glass, 5 Port 63mm Gauges, Blue Body (with Rubber Boots) R1 34A/R404A/R407C

SERVICE MANIFOLDS PARTS ILLUSTRATIONS

S10 AND S20 SERIES 2-VALVE MANIFOLD

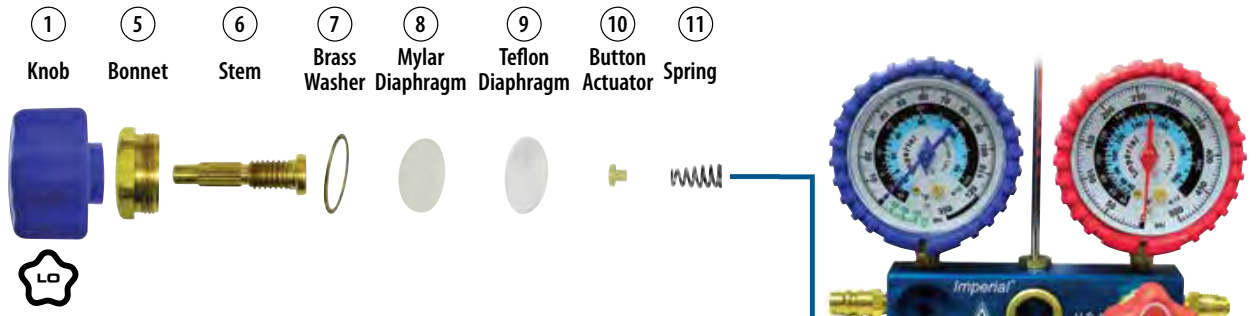
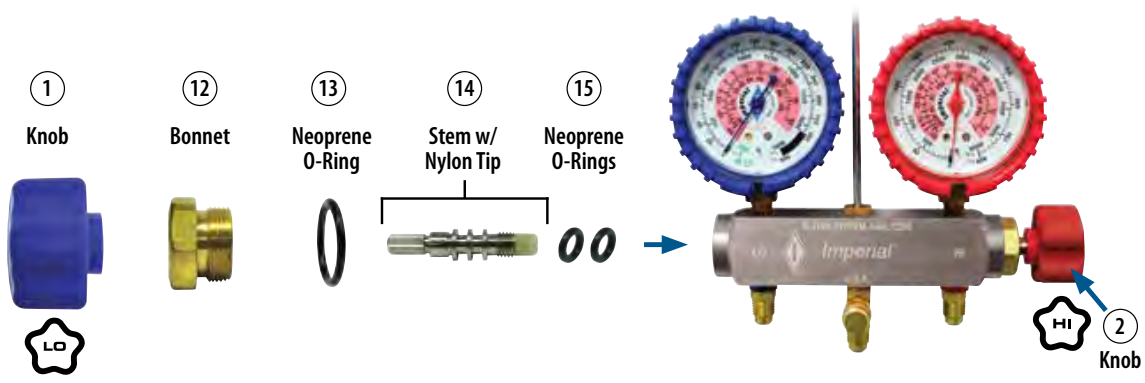

REPLACEMENT PARTS LIST

Part No	1	2	3	4	5	6	7	8	9	10	11	12	13	14	15	16	17	18	19
10SG																1			
405-RH*				1													1	1	1
405-RL*			1														1	1	1
500-RH*		1										1	1	1	2				
500-RL*	1											1	1	1	2				
600-R							2	2	2	2	2								
602-RK	1	1				2													
S64104									10										
S64108							10												
S64870										10	10								
S69021								10											
S76548				2															

* These kits are shipped completely assembled for quick and easy replacement.

400 AND 300 SERIES 2-VALVE BRASS MANIFOLD

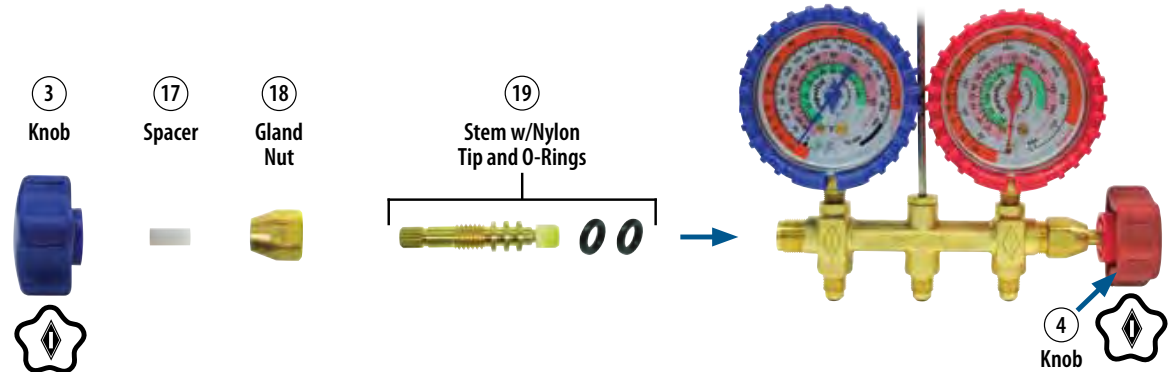

GAUGES & HOSES

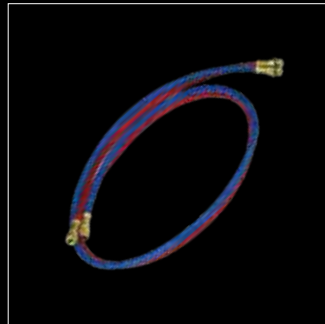

PRECISION REFRIGERANT GAUGES



PRECISION REFRIGERANT GAUGES

WITH HI-VISIBILITY COLOR-CODED REFRIGERANT SCALES

- **Superior Shock Resistance** - Our unique design isolates the movement from the socket, reducing the effects of shock.
- **Superior Vibration Resistance** - Our enhanced vibration dampening design cushions the movement for flutter-free performance and extended gauge service life.
- **Superior Pulsation Resistance** - After 10 million cycles, these gauges show three times less wear than conventional gauges. The result is a longer lasting, more reliable gauge.



Protective rubber boots for 2-1/2" gauges sold separately.

2-1/2" GAUGES

- 1/8" MNPT Connections
- 3 : 2 : 3% Accuracy
- Replacement Screw-on Lens Set- S8230301
- Protective Red & Blue Rubber Boot Set - 400-RB

PART NO.	DESCRIPTION	GAUGE CALIBRATION					TEMP	
		PSI	BAR	Kg/cm ²	kPa	MPa	°F	°C
R-12, R-134a								
441-CB	Blue Compound	●					●	
441-CR	Red Pressure	●					●	
R-12, R-22, R-502								
323-CR	Red Pressure	●					●	
325-CB	Blue Compound	●					●	
405-CB	Blue Compound	●	●				●	●
405-CR	Red Pressure	●	●				●	●
423-CAM	Red Pressure			●			●	●
423-CAPD	Red Pressure					●	●	●
423-CK	Red Pressure				●		●	●
423-CKP	Red Pressure	●			●		●	●
423-CR	Red Pressure	●					●	●
425-CAM	Blue Compound			●			●	●
425-CAPD	Blue Compound					●	●	●
425-CB	Blue Compound	●					●	●
425-CK	Blue Compound			●			●	●
425-CKP	Blue Compound	●			●		●	●
431-CM	Red Pressure	●		●			●	●
432-CM	Blue Compound	●		●			●	●
R-22, R-404A, R-410A								
422-CB	Blue Compound	●					●	●
422-CR	Red Pressure	●					●	●
R-32, R-410A *NEW*								
453-CB	Blue Compound	●			●		●	●
453-CR	Red Pressure	●			●		●	●

PART NO.	DESCRIPTION	GAUGE CALIBRATION					TEMP	
		PSI	BAR	Kg/cm ²	kPa	MPa	°F	°C
R-22, R-407C, R-410A								
406-CB	Blue Compound	●					●	●
406-CR	Red Pressure	●					●	●
428-CKP	Blue Compound	●			●		●	●
429-CKP	Red Pressure	●			●		●	●
R-22, R-404A, R-507								
426-CKP	Blue Compound	●			●		●	●
427-CKP	Red Pressure	●			●		●	●
R-22, R-134a, R-404A								
420-BCKP	Blue Compound	●			●		●	●
420-RCKP	Red Pressure	●			●		●	●
424-CB	Blue Compound						●	●
424-CR	Red Pressure	●					●	●
R-134a								
434-BKP	Blue Compound	●			●		●	●
434-RKP	Red Pressure	●			●		●	●
R-134a, R-404A, R-407C								
407-CB	Blue Compound	●	●				●	●
407-CR	Red Pressure	●	●				●	●
R-134a, R-404A, R-507								
451-CB	Blue Compound	●					●	●
451-CBM	Blue Compound			●	●		●	●
451-CR	Red Pressure	●					●	●
451-CRM	Red Pressure			●	●		●	●
R-410A								
2423-P	Red Pressure			●			●	●
2425-CP	Blue Compound			●			●	●
408-CB	Blue Compound	●	●				●	●
408-CR	Red Pressure	●	●				●	●
452-CB	Blue Compound	●			●		●	●
452-CR	Red Pressure	●			●		●	●

80MM (3-1/8") Class 1 GAUGES *NEW*

- 1/8" MNPT Connections
- 1% Accuracy

PART NO.	DESCRIPTION	GAUGE CALIBRATION					TEMP	
		PSI	BAR	Kg/cm ²	kPa	MPa	°F	°C
R-404A, R-410A, R-22								
404-CB	Blue Compound	●					●	●
404-CR	Red Pressure	●					●	●
R-22, R-134a, R-404A								
458-CB	Blue Compound	●					●	●
458-CR	Red Pressure	●					●	●
R-407C, R-410A, R-22								
459-CB	Blue Compound	●					●	●
459-CR	Red Pressure	●					●	●
R-410A								
460-CB	Blue Compound	●					●	●
460-CR	Red Pressure	●					●	●

POLARSHIELD CHARGING HOSE

950, 900, 850 & 800 SERIES

- **All Imperial® PolarShield® charging hoses are UL recognized** and meet UL-1963, SAE-J2196 & EPA requirements for strength, pressure and refrigerant permeation.
- **Rugged, Multi-Refrigerant Nylon Barrier Construction** - PolarShield hoses are compatible with all CFC, HFC & HCFC refrigerants (R-410A, R-404A, R-407C, R-134a).
- **High-Pressure** - PolarShield hoses feature 800 PSI working pressure and 4,000 PSI burst pressure with a 5-to-1 safety factor.
- **Selection** - PolarShield hoses are available with a variety of end connections, in yellow, red or blue, individually or in sets of three. Consult factory for lengths and end connections not listed below.

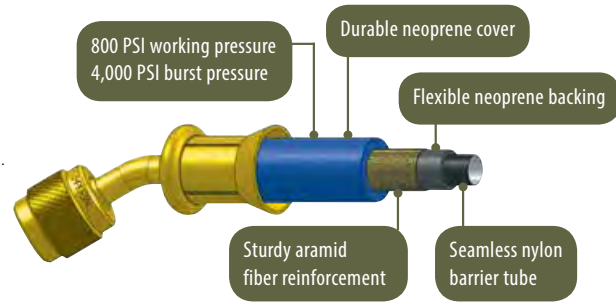

950 SERIES HOSES WITH LOW LOSS BALL VALVE SHUT-OFF AND 1/4" FFL* CONNECTIONS

LENGTH	BLUE	YELLOW	RED	SET OF THREE (B,Y,R)
3'(36")	953-MRB	953-MRY	953-MRR	953-MRS
5'(60")	955-MRB	955-MRY	955-MRR	955-MRS
6'(72")	956-MRB	956-MRY	956-MRR	956-MRS

*5/16" fittings available-contact factory for part numbers

900 SERIES POLARSHIELD HOSES WITH AUTOMATIC SHUT-OFF VALVE

Precision engineered automatic low loss 1/4" FFL* shut-off valve traps refrigerant within the hose to eliminate venting and finger burn.

900 SERIES HOSES - (1/4" FFL* CONNECTIONS WITH AUTOMATIC SHUT-OFF ON ONE END)

LENGTH	BLUE	YELLOW	RED	SET OF THREE (B,Y,R)
3'(36")	903-MRB	903-MRY	903-MRR	903-MRS
5'(60")	905-MRB	905-MRY	905-MRR	905-MRS
6'(72")	906-MRB	906-MRY	906-MRR	906-MRS

*5/16" fittings available-contact factory for part numbers

850 SERIES PolarShield® HOSES FOR R-410A SYSTEMS WITH 5/16" ACCESS FITTINGS (1/4" x 5/16" hose connections)

LENGTH	BLUE	YELLOW	RED	SET OF THREE (B,Y,R)
3'(36")	853-MRB	853-MRY	853-MRR	853-MRS
4'(48")	854-MRB	854-MRY	854-MRR	854-MRS
5'(60")	855-MRB	855-MRY	855-MRR	855-MRS
6'(72")	856-MRB	856-MRY	856-MRR	856-MRS

800 SERIES PolarShield® HOSES WITH STANDARD 1/4" FITTINGS*

LENGTH	BLUE	YELLOW	RED	SET OF THREE (B,Y,R)
3'(36")	803-MRB	803-MRY	803-MRR	803-MRS
4'(48")	804-MRB	804-MRY	804-MRR	804-MRS
5'(60")	805-MRB	805-MRY	805-MRR	805-MRS
6'(72")	806-MRB	806-MRY	806-MRR	806-MRS
8'(96")	808-MRB	808-MRY	808-MRR	808-MRS
12'(144")	812-MRB	812-MRY	812-MRR	812-MRS

*5/16" fittings available-contact factory for part numbers

3/8" EVACUATION HOSE WITH 3/8" SAE SWIVEL CONNECTION

For faster evacuation and charging

3/8" hose in four lengths for larger jobs or applications where reduced service time is desired. 3/8" swivel ends. Eight-crimp ferrules. Available in yellow.

LENGTH	YELLOW
3'(36")	536-FTY
4'(48")	548-FTY
5'(60")	560-FTY
6'(72")	572-FTY



6" LOW LOSS VALVE ADAPTOR HOSES

1/4" SAE 45° female x 1/4" SAE male straight fittings

Connects to any 1/4" SAE charging line. Non-restrictive for maximum flow. UL recognized - environmentally safe.



LENGTH	BLUE	YELLOW	RED	SET OF THREE (B,Y,R)
6"	800-MBB	800-MBY	800-MBR	800-MBS

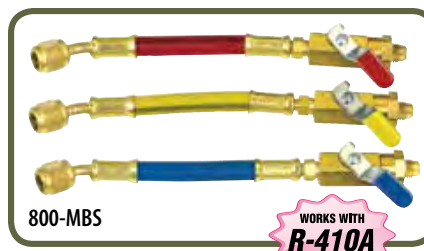

800-MBS



IMPERIAL - POLARSHIELD HIGH-PERFORMANCE CHARGING HOSES

- Compatible with all I-FC, HCFC & HFO refrigerants.
- Feature 800 PSI working pressure and 4,000 PSI burst pressure with a 5 to 1 safety factor
- Available with a variety of end connections, in yellow, red or blue, individually or in sets of three.



STANDARD HOSE SETS

36" hoses	60" hoses	72" Hoses	Description	Pack qty
IMP-803MRS	IMP-805MRS	IMP-806MRS	1/4" x 1/4" (red, yellow, blue)	Pack of 3
IMP-853MRS	IMP-855MRS	IMP-856MRS	1/4" x 5/16" (red, yellow, blue) R410A/R32	Pack of 3



SINGLE HOSES

36" hoses	60" hoses	72" Hoses	Description	Pack qty
IMP-803MRY	IMP-805MRY	IMP-806MRY	1/4" x 1/4" (yellow)	Single
IMP-803MRR	IMP-805MRR	IMP-806MRR	1/4" x 1/4" (red)	Single
IMP-803MRB	IMP-805MRB	IMP-806MRB	1/4" x 1/4" (blue)	Single
IMP-853MRY	IMP-855MRY	IMP-856MRY	1/4" x 5/16" (yellow) R410A/R32	Single
IMP-853MRR	IMP-855MRR	IMP-856MRR	1/4" x 5/16" (red) R410A/R32	Single
IMP-853MRB	IMP-855MRB	IMP-856MRB	1/4" x 5/16" (blue) R410A/R32	Single



VACUUM HOSES

36" hoses	72" Hoses	Description	Pack qty
IMP-536FTY	IMP-572FTY	3/8" x 3/8" (yellow)	Single



KWIK-COUPLER ADAPTORS

1/4"F x 1/4"M	5/16"F x 5/16" M	Description	Pack qty
IMP-16C	IMP-26C	Straight coupler (45° Flare)	Single
IMP-17C	IMP-27C	90° Elbow Coupler (45° Flare)	Single

Part code	Description	Pack qty
IMP-18C	Set includes IMP-16C and IMP-17C	Pack of 2
IMP-28C	Set includes IMP-26C and IMP-27C	Pack of 2
20128	1/4" to 5/16" brass adaptor	Pack of 1



HOSE GASKETS

Part code	Description	Pack qty
IMP-S7958301	Hose gaskets for 1/4" hose	Pack of 10
IMP-S7958302	Hose gaskets for 3/8" hose	Pack of 10
IMP-S7958302	Hose gaskets for 5/16" hose	Pack of 10



IMPERIAL SPARES PRECISION REFRIGERANT GAUGES

The replacement gauges have high visibility colour-Part coded refrigerant scales. The unique design isolates the movement from the socket creating a superior shock resistance. The enhanced vibration dampening design cushions the movement for flutter-free performance and extended service life. With a superior pulsation resistance, after 10 million cycles, these gauges show three times less wear than conventional gauges. The result is a longer lasting, more reliable gauge.

63MM (2-1/2")

80MM (3-1/8")



MODEL SHOWN
IMP-420BCKP

MODEL SHOWN
IMP-420BCKP

Part code	Description - 63mm (2-1/2")	Refrigerant	Colour	Pack qty
IMP-406CB	Single gauge 63mm (2-1/2")	R22, R41 0A, R407C - PSI, °C	Blue	Single
IMP-406CR	Single gauge 63mm (2-1/2")	R22, R41 0A, R407C - PSI, °C	Red	Single
IMP-407CB	Single gauge 63mm (2-1/2")	R1 34A, R404A, R407C - PSI, Bar, °C	Blue	Single
IMP-407CR	Single gauge 63mm (2-1/2")	R1 34A, R404A, R407C - PSI, Bar, °C	Red	Single
IMP-408CB	Single gauge 63mm (2-1/2")	R410A - PSI, Bar, °C	Blue	Single
IMP-408CR	Single gauge 63mm (2-1/2")	R410A - PSI, Bar, °C	Red	Single
IMP-420BCKP	Single gauge 63mm (2-1/2")	R134A, R404A, R22 - PSI, KPA. °C / °F	Blue	Single
IMP-420RCKP	Single gauge 63mm (2-1/2")	R134A, R404A, R22 - PSI, KPA. °C / °F	Red	Single
IMP-453CB	Single gauge 63mm (2-1/2")	R41 0A - PSI, kPa, °C	Blue	Single
IMP-453CR	Single gauge 63mm (2-1/2")	R41 0A - PSI, kPa, °C	Red	Single

Part code	Description - 80mm (3-1/8")	Refrigerant	Colour	Pack qty
IMP-406CB	Single gauge 80mm (3-1/8")	R22, R41 0A, R407C - PSI, °C	Blue	Single
IMP-406CR	Single gauge 80mm (3-1/8")	R22, R41 0A, R407C - PSI, °C	Red	Single
IMP-407CB	Single gauge 80mm (3-1/8")	R1 34A, R404A, R407C - PSI, Bar, °C	Blue	Single
IMP-407CR	Single gauge 80mm (3-1/8")	R1 34A, R404A, R407C - PSI, Bar, °C	Red	Single
IMP-408CB	Single gauge 80mm (3-1/8")	R410A - PSI, Bar, °C	Blue	Single
IMP-408CR	Single gauge 80mm (3-1/8")	R410A - PSI, Bar, °C	Red	Single
IMP-420BCKP	Single gauge 80mm (3-1/8")	R134A, R404A, R22 - PSI, KPA. °C / °F	Blue	Single
IMP-420RCKP	Single gauge 80mm (3-1/8")	R134A, R404A, R22 - PSI, KPA. °C / °F	Red	Single
IMP-453CB	Single gauge 80mm (3-1/8")	R41 0A - PSI, kPa, °C	Blue	Single
IMP-453CR	Single gauge 80mm (3-1/8")	R41 0A - PSI, kPa, °C	Red	Single

MANIFOLD REPLACEMENT PARTS

A range of manifold replacement parts are sold in single pack quantities of each item. If you would like more information on our manifolds please contact the sales department on +44(0)115 900 5858.



Part code	Description	Pack qty
IMP-406CB	Rubber Boots Kit - Blue & Red (63mm gauges only) - kit contains 1 x blue and 1 x red	Single
IMP-406CR	Manifold Diaphragm Repair Kit	Single
IMP-407CB	Replacement VAC & REF Knob Kit with Stems - Black and Yellow	Single
IMP-407CR	Replacement HI & LO Knob Kit with Stems - Red and Blue	Single
IMP-408CB	Replacement VAC, REF, HI, LO, Knob Kit with Stem and Diaphragm	Single
IMP-408CR	Replacement Hanging Hook	Single

GET IN. GET OUT. GET ON TO THE NEXT JOB.



Flaring and swaging is a big part of the job. That's why we made a big effort to guarantee you get a precise flare and swage every time. Convenience and comfort both come standard throughout hilmor's full line of flaring and swaging tools. Simply choose the tool that fits your needs, and get ready to conquer your next job.

HILMOR RANGE

HILMOR RANGE

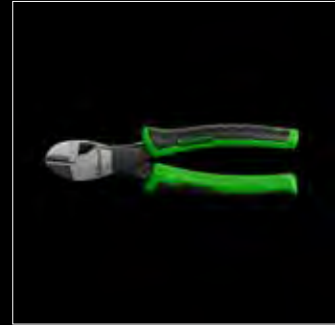



1935917
REFRIGERATION HOSES
WITH BALL VALVE ENDS

REFRIGERATION HOSES WITH BALL VALVE ENDS

Our retooled hoses includes an easy turn valve for added control of refrigerant loss. Features an extra abrasion-resistant layer for superior protection in tough conditions. All of our hoses are rated for 800 PSI working pressure to work with the newest high-pressure refrigerants.



MINIMISE REFRIGERANT LOSS

EASY-TURN VALVE FOR ADDED CONTROL OF REFRIGERANT LOSS



HANDLES HIGH PRESSURE

RATED FOR 800PSI WORKING PRESSURE TO WORK WITH HIGH-PRESSURE REFRIGERANTS



SMALL SPACE CAPABLE

A COMPACT DESIGN ALLOWS IT TO BE USED EVEN IN CRAMPED SPACES

Part code	Description	Diameter	MAX allowable working pressure	Burst pressure	Operating temp	End connection	Weight
1935917	H48BVES3 Set of 3 - 48"	1/4"	800 PSI	4000 PSI	-20° F to 180° F	Straight by 45°	1.8lbs
1935918	H48BVEBV Vacuum - 48"	3/8"	800 PSI	4000 PSI	-20° F to 180° F	Straight by 45°	1.8lbs
1935924	H60BVES3 Set of 3 - 60"	1/4"	800 PSI	4000 PSI	-20° F to 180° F	Straight by 45°	1.8lbs
1935926	H60BVEBV Ball Valve - 60"	3/8"	800 PSI	4000 PSI	-20° F to 180° F	Straight by 45°	1.8lbs



SOFT TUBING ONLY COPPER, STEEL, ALUMINUM, BRASS

COMPACT BENDER KITS

1839032 COMPACT BENDER KIT

Body and crossbar for 1/4" to 7/8", 1/4", 5/16", 3/8", 1/2", 5/8", 3/4" and 7/8" mandrels.

1926598 COMPACT BENDER KIT WITH REVERSE BENDING ATTACHMENT

Body and crossbar for 1/4" to 7/8", 1/4", 5/16", 3/8", 1/2", 5/8", 3/4", 7/8" mandrels and Reverse Bending Attachment.



SIMPLE SETUP

UNIVERSAL CROSSBAR AND COLOR-CODED MANDRELS MAKE IDENTIFYING AND CHANGING SIZES QUICK AND EASY.



ONE-HANDED OPERATION

A RATCHETING MECHANISM AND INNOVATIVE RELEASE LEVER ALLOW FOR BENDING WITH ONE HAND.



SMALL SPACE CAPABLE

A COMPACT DESIGN ALLOWS IT TO BE USED EVEN IN CRAMPED SPACES



A REVERSE BENDING ATTACHMENT FOR BENDS IN THE OPPOSITE DIRECTION.



A RATCHETING LEVER GIVES YOU THE BRAUN TO BEND TUBES WITH ONE HAND.



A QUICK-RELEASE BUTTON ALLOWS YOU TO FREE THE TUBE WITH EASE AND WITHOUT DAMAGE.



A LOCKING SLIDER KEEPS THE BENDER COMPACT FOR STORAGE AND TRANSPORT.

Part code	Description	Tube sizes (O.D.)	Length	Width	Height	Weight
1839032	CBK	1/4", 5/16"	16-3/8"	12-1/4"	3-1/4"	8.8 lbs
1926598	CBKRB	1/4", 5/16"	16-3/8"	12-1/4"	3-1/4"	10.8 lbs

Replacement parts

1890999	CBRBM Rev Bend Att	-	-	-	-	-
---------	--------------------	---	---	---	---	---



SOFT TUBING ONLY COPPER, STEEL, ALUMINIUM, BRASS

TRI-TUBE BENDERS

From start to final bend, the Hilmor Tri-Tube Benders have you covered.



PRECISE ANGLES

CALIBRATED MARKINGS FOR MAKING ACCURATE BENDS UP TO 180°



COMFORTABLE GRIP

NON-SLIP GRIP



LIGHTEN YOUR LOAD

CONSTRUCTED OUT OF LIGHTWEIGHT DIE-CAST ALUMINIUM



INDEXING HANDLE

INDEXING HANDLE COMPACT DESIGN FOR TIGHT ACCESS. (1839026 ONLY)

Part code	Description	Tube sizes (O.D.)	Length	Width	Height	Weight
1839026	TB31638	3/16", 1/4", 5/16", 3/8"	2-1/2"	6"	12-1/2"	1.8 lbs
1839027	TB31612	3/16", 1/4", 3/8", 1/2"	3-1/2"	7-1/2"	7"	2.5 lbs

SPRING BENDERS

Getting an accurate bend by hand isn't always easy. But, our Spring Benders can help simplify things. Four different benders are included to fit 1/4", 3/8", 1/2" and 5/8" tubing. Simply slip the Spring Bender over soft copper or aluminum tubing, and count on the spring to keep the tube from kinking.



Part code	Description	Tube sizes (O.D.)	Length	Weight
1839031	SB 4PC Set	1/4" 3/8" 1/2" 5/8"	11-1/3"	5 oz

HILMOR GEAR BENDERS

7/8", 1-1/8" and 1-3/8" O.D. tubing for bending soft and half-hard copper, aluminium brass, steel and other tubing and pipe which had been tempered and is suitable for bending.

- For 7/8", 1-1/8" and 1-3/8" O.D. tubing
- Full 180° bending radius without repositioning
- Four internal main gears which maximizes engagement and reduces gear slippage producing wrinkle free bends



NB: WE RECOMMEND USING THE HILMOR TRIPOD (HIL-270-TRIPOD) WITH THIS BENDER. PLEASE NOTE IMPROPER USE OR MOUNTING COULD DAMAGE THE BENDER AND WILL INVALIDATE THE WARRANTY.

WARNING: THERE IS RISK OF INJURY IF YOU DO NOT KEEP YOUR HANDS AWAY FROM THE CENTRAL GEAR MECHANISM!

PARTS



- | | | |
|--------------------|----------------|--------------------------------|
| 1. Locking pin | 3. Guide | 5. Mounting points |
| 2. Securing screws | 4. Gear bender | 6. Ratchet wrench (extendable) |



Code	Item
HIL-270-F-14-GEARBEND	HILMOR 7/8" GEAR BENDER (no tripod)
HIL-270-F-18-GEARBEND	HILMOR 270-F-18 - 1-1/8 OD GEAR BENDER (no tripod)
HIL-270-F-20-GEARBEND	HILMOR 1-3/8" GEAR BENDER (no tripod)
HIL-270-F-14-KIT	HILMOR 270-F-14 - 7/8" OD gear bender with tripod
HIL-270-F-18-KIT	HILMOR 270-F-18 - 1-1/8 OD gear bender with tripod
HIL-270-F-20-KIT	HILMOR 270-F-20 - 1-3/8 OD gear bender with tripod
HIL-270-TRIPOD	HILMOR tripod for gear bender

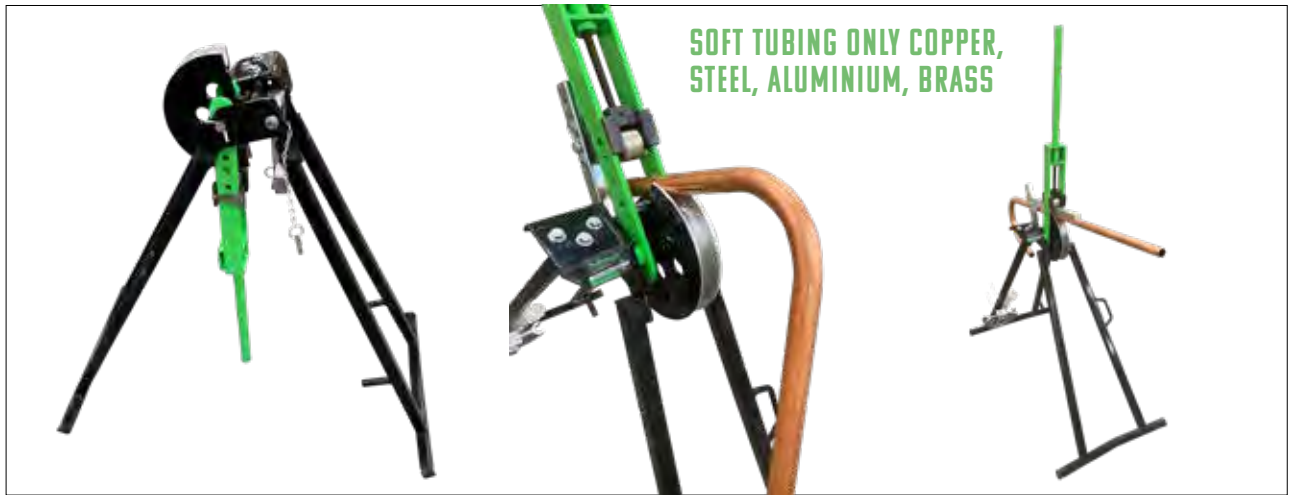

SOFT TUBING ONLY COPPER, STEEL, ALUMINIUM, BRASS

HIL-CM TUBE BENDER

Capacities

CM35

15, 22 & 28mm copper to BS2871.

15, 22, & 28mm mild steel to BS4182.

15, 22 & 28mm stainless steel to BS4127

7/8" & 1-1/8" copper

PRECISE ANGLES

CALIBRATED MARKINGS FOR MAKING ACCURATE BENDS UP TO 180°

COMFORTABLE GRIP

NON-SLIP GRIP

Model	Description
HIL- CM35-MO	CM35 Frame only
HIL-CM35-15 to 28	CM35 Frame 15mm, 22mm and 28mm Former and Guides
HIL-CM35-IMP-7/8 to 1-1/8	CM35 Frame 7/8" and 1-1/8" Former and Guides

Model	Description
HIL- EL25-MO	EL25 Machine and Vice
HIL- EL25-20-25	EL25 Machine, Vice, 20mm and 25mm Formers

Part code	Description
Kits	
HIL-CM35-15-28	A Frame Bender 15, 22 & 28mm formers and guides
HIL-CM35-7/8-1 1/8	A Frame Bender 7/8" & 1 1/8" formers and guides
Parts	
HIL-CM35-15DISC	15mm Former Disc
HIL-CM35-22DISC	22mm Former Disc
HIL-CM35-28DISC	28mm Former Disc
HIL-CM35-7/8DISC	7/8" Former Disc

Part code	Description
Parts	
HIL-CM35-1-1/8DISC	1 1/8" Former Disc
HIL-CM35-15GUIDE	15mm GUIDE
HIL-CM35-22GUIDE	22mm GUIDE
HIL-CM35-28GUIDE	28mm GUIDE
HIL-CM35-7/8GUIDE	7/8" GUIDE
HIL-CM35-1-1/8GUIDE	1 1/8" GUIDE



hilmor WARRANTY

At hilmor, we have put the highest priority on thoughtful product design and manufacturing quality. That is why we guarantee our products to be free of material and workmanship defects for a period of time from purchase (see chart below). We get the tough conditions in which you work and have designed products to stand up to those challenges. Unfortunately, this warranty does not apply to product that has been damaged as a result of improper maintenance, accident or other misuse, or which fails to operate due to normal wear and tear.

Product Line	Time Period from Purchase
Power Tool Accessories, Deburring Tools, Gloves, Drill Bits, Tube Brushes, Cutting Wheels and Blades	Limited 90 Days
Refrigeration Scale	Limited One Year
Analog Gauges	Limited One Year
Recovery Machine	Limited One Year
Hoses	Limited One Year
Valve Core Removal Tools	Limited One Year
Wireless Vacuum Gauge	Limited Two Years
Vacuum Pumps	Limited Two Years
Digital Adjustable Torque Wrench	Limited Two Years
Electronics	Limited Three Years
Manifold Bar	Limited Lifetime
Bending Tools	Limited Lifetime
Flaring Tools	Limited Lifetime
Swaging Tools	Limited Lifetime
Tubing Cutters	Limited Lifetime
Sheet Metal and Duct Tools	Limited Lifetime
Driving Tools	Limited Lifetime
Pliers, Wrenches and Wire Strippers	Limited Lifetime
Utility Knives	Limited Lifetime
Service Tools	Limited Lifetime
Fin Tools	Limited Lifetime
Inspection Mirrors	Limited Lifetime
Tool Storage Bags	Limited Lifetime

All products, that are subject to warranty claims should be returned to the place of purchase along with proof of purchase showing the date of purchase. The distributor from whom the product was purchased will contact hilmor for next steps, which could include field scrap or return to the factory for analysis, and work with you on a repair, replacement or credit. Please contact hilmor Technical Services for general technical questions related to products or this warranty policy: **1-800-995-2222**.

HILMOR MAKES NO OTHER WARRANTIES, EXPRESS OR IMPLIED, CONCERNING THE PRODUCT OR THE MERCHANTABILITY OR FITNESS THEREOF FOR ANY PURPOSE. IN NO EVENT SHALL HILMOR AND ITS AFFILIATES, SUCCESSORS AND ASSIGNS) BE LIABLE FOR INCIDENTAL, CONSEQUENTIAL OR PUNITIVE DAMAGES (OR LOST PROFITS), REGARDLESS OF THE NATURE OF THE CLAIM.



AN OFF-CENTER MOUNTED CONE HELPS TO UNIFORMLY SHAPE THE TUBE.

A CLUTCH MECHANISM STOPS THE FLARE WHEN THE JOB IS DONE TO ELIMINATE CRACKING THE TUBE.

ORBITAL FLARE
1838952

SOFT TUBING ONLY COPPER,
STEEL, ALUMINIUM, BRASS

ORBITAL FLARE

The Hilmor Orbital Flare was designed to produce quality flares – again and again. A tube-stop arrow allows precise positioning and placement so you can keep that nickel in your pocket. Plus, a clutch mechanism stops the flare to eliminate cracking the tube.



PRECISE FLARES, EVERY TIME

AN OFF-CENTER MOUNTED CONE SPINS ON AN AXIS TO EFFECTIVELY PRODUCE QUALITY FLARES



NO CRACKED TUBES

A CLUTCH MECHANISM STOPS THE FLARING WHEN THE JOB IS DONE



SIMPLE SETUP

A CLOTHESPIN-INSPIRED, SPRING-LOADED BLOCK GRIPS THE TUBE SECURELY



EASY TO POSITION

A TUBE-STOP ARROW SLIDES TO SET CORRECT HEIGHT AND POSITIONING WHILE BALL DETENTS ALLOW FOR EASY FLARING CONE ALIGNMENT.

Part code	Description	Flare type	Tube sizes (O.D.)	Length	Width	Height	Weight
1838952	FTO	45°	3/16", 1/4", 5/16", 3/8", 1/2", 5/8", 3/4"	8-1/2"	4-5/8"	5-1/4"	3.8 lbs





SOFT TUBING ONLY COPPER, STEEL, ALUMINIUM, BRASS

KIT CONTENTS:
1 BAR, 1 QUICK-ENGAGE YOKE, 1 FLARE CONE 3/16" TO 3/4", 5 SWAGE HEADS

QUICK-ENGAGE FLARE AND SWAGE KIT

Extra appendages are hard to come by these days. Instead, opt for the all-new Hilmor Quick-Engage Flare and Swage. Simple setup, precise positioning and a secure hold allow you to quickly conquer and move on to the next job.

- 

LESS WORK
ALLOWS FOR FASTER FLARES AND SWAGES BECAUSE IT REQUIRES FEWER ROTATIONS
- 

SIMPLE SETUP
A CLOTHESPIN-INSPIRED, SPRING-LOADED BLOCK GRIPS THE TUBE SECURELY
- 

EASY TO POSITION
A TUBE-STOP ARROW SLIDES TO SET CORRECT HEIGHT AND POSITIONING WHILE BALL DETENTS ALLOW FOR EASY FLARING CONE ALIGNMENT.



BALL DETENTS ENSURE PROPER AND PRECISE ALIGNMENT TO GUARANTEE A PERFECT FLARE OR SWAGE EVERY TIME.



PUSH DOWN THE YOKE AND WITH FEWER ROTATIONS, YOU GET A PRECISE FLARE OR SWAGE.



AN INNOVATIVE SPRING-LOADED BLOCK HOLDS THE TUBE FIRMLY IN PLACE.

Part code	Description	Flare type	Tube sizes (O.D.)	Length	Width	Height	Weight
1838947	FS	45°	3/16", 1/4", 5/16", 3/8", 1/2", 5/8", 3/4"	8-1/2"	4-5/8"	7-1/2"	3.5 lbs



COMPACT SWAGE TOOL KIT
1839015

**SOFT TUBING ONLY COPPER,
STEEL, ALUMINIUM, BRASS**

KIT CONTENTS:
3/8", 1/2", 5/8", 3/4", 7/8"
EXPANDER HEADS, DEBURRER,
COMPACT SWAGE TOOL

**RECOMMENDED
REPLACEMENT HYDRAULIC
FLUID HV-15**

**RECOMMENDED EXPANDER
HEAD LUBRICANT NLGI1 OR
NLGI2**

COMPACT SWAGE TOOL KIT

The new Hilmor Compact Swage Tool is taking swaging to the next level. It has the power to swage 2-1/8" tubing and the control to swage 1/4" tubing without a crack. With its small, pistol-shape design, it can fit in the smallest of spaces. This proprietary design can reduce on-the-job fatigue with its easy setup and one-handed operation made possible by an innovative hydraulic mechanism and release button. It's even equipped for multiple sizes.



PICTURE-PERFECT SWAGING

SIMPLY SELECT THE CORRECT HEAD, PLACE IT ON THE TOOL AND MAKE A QUALITY SWAGE



LESS EFFORT, MORE CONTROL

THE POWER TO SWAGE 1-5/8" TUBING AND THE CONTROL TO SWAGE 5/16" WITHOUT SPLITTING THE TUBE



SMALL SPACE CAPABLE

A COMPACT DESIGN ALLOWS IT TO BE USED EVEN IN CRAMPED SPACES



ONE-HANDED OPERATION

THE LEVER MECHANISM AND RELEASE BUTTON ALLOW FOR ONE-HANDED SWAGING WITHOUT THE FATIGUE

Part code	Description	Tube sizes (O.D.)	Length	Width	Height	Weight
1839015	CS	3/8", 1/2", 5/8", 3/4", 7/8"	9"	1-3/4"	5"	8.5 lbs

EXPANDER HEADS & REPLACEMENT PARTS

Part code	Description	Sizes
1964042	CSEH14 Expander Head	1/4"
1839016	CSEH516 Expander Head	5/16"
1839017	CSEH38 Expander Head	3/8"
1839018	CSEH12 Expander Head	1/2"
1839019	CSEH58 Expander Head	5/8"
1839020	CSEH34 Expander Head	3/4"

Part code	Description	Sizes
1839021	CSEH78 Expander Head	7/8"
1839022	CSEH118 Expander Head	1-1/8"
1839023	CSEH138 Expander Head	1-3/8"
1839024	CSEH158 Expander Head	1-5/8"
1964043	CSEH218 Expander Head	2-1/8"
1839025	CSB Compact Swage Body Kit	N/A
1891258	Pocket Size Deburring Tool	N/A



SOFT TUBING ONLY COPPER, STEEL, ALUMINIUM, BRASS

DELUXE COMPACT SWAGE TOOL KIT
1964041

DELUXE KIT CONTENTS:
1/4", 5/16", 3/8", 1/2", 5/8", 3/4", 7/8", 1-1/8", 1-3/8", 1-5/8" EXPANDER HEADS, POCKET SIZE DEBURRING TOOL, COMPACT SWAGE TOOL

DELUXE COMPACT SWAGE TOOL KIT

Thoughtfully designed to fit into the smallest of spaces, the Hilmor Compact Swage Tool can knock out the picture-perfect swage in just one shot. An innovative hydraulic mechanism and release button let you take care of any job single-handedly.



PICTURE-PERFECT SWAGING

SIMPLY SELECT THE CORRECT HEAD, PLACE IT ON THE TOOL AND MAKE A QUALITY SWAGE



ONE-HANDED OPERATION

THE LEVER MECHANISM AND RELEASE BUTTON ALLOW FOR ONE-HANDED SWAGING WITHOUT THE FATIGUE

Part code	Description	Tube sizes (O.D.)	Length	Width	Height	Weight
1964041	DCS	1/4", 5/16", 3/8", 1/2", 5/8", 3/4", 7/8", 1-1/8", 1-3/8", 1-5/8"	9"	1-3/4"	5"	8.5 lbs

ADDITIONAL EXPANDER HEADS

Part code	Description	Sizes
1964042	CSEH14 Expander Head	1/4"
1964043	CSEH218 Expander Head	2-1/8"



SMALL DIAMETER TUBE CUTTERS

When you're in a tight space, this tool can definitely cut it. Hilmor's ruggedly durable Small Diameter Tubing Cutters offer precision cuts with minimal burrs.



RUGGED AND DURABLE

AN ERGONOMIC, CAST-ZINC BODY AND SHOCK-RESISTANT STEEL WHEEL REDUCE BURRS WHILE INCREASING LIFE AND DURABILITY



SMALL SPACE CAPABLE

A COMPACT DESIGN ALLOWS IT TO BE USED EVEN IN CRAMPED SPACES



MAXIMUM PROTECTION

A FULL-STOP THREADING SYSTEM OFFERS MAXIMUM PROTECTION FOR CUTTING WHEELS



PRECISION FLARE CUTTING

A FLARE-CUTTING GROOVE ALLOWS FOR PRECISION REMOVAL OF MATERIAL. ITEM 1885383 ONLY



SPARE BLADE STORAGE



A BONUS BLADE COMES WITH THE TOOL AND CAN BE STORED EASILY IN THE HANDLE. ITEMS 1885382 & 1885383 ONLY

Part code	Description	Diameter	Length	Width	Height	Weight
1885381	TC1858	1/8" - 5/8"	1-3/8"	3/4"	1-3/4"	4 oz
1885382	TC181	1/8" - 1"	1-3/4"	3/4"	2-3/8"	6 oz
1885383	TC18118 TC	1/8" - 1-1/8"	2"	1"	3"	8 oz



LARGE DIAMETER TUBE CUTTERS

This cutter can talk the talk without walking the walk. Hilmor’s Large Diameter Tubing Cutters feature a four-roller tracking system to keep the tube from threading. All the while, a shock-resistant steel wheel cuts through the tube like a knife through butter.

 <p>RUGGED AND DURABLE AN ERGONOMIC, CAST-ZINC BODY AND SHOCK-RESISTANT STEEL WHEEL REDUCE BURRS WHILE INCREASING LIFE AND DURABILITY</p>	 <p>ACCURATE CUTTING A UNIQUE, FOUR-ROLLER TRACKING SYSTEM KEEPS THE TUBE FROM THREADING</p>
 <p>PRECISION FLARE CUTTING A FLARE-CUTTING GROOVE ALLOWS FOR PRECISION REMOVAL OF MATERIAL. ITEM 1885383 ONLY</p>	 <p>PROFESSIONAL DEBURRING CONVENIENTLY DEBURR TUBES WITH A REPLACEABLE MACHINIST’S REAMER.</p>
 <p>MAXIMUM PROTECTION A FULL-STOP THREADING SYSTEM OFFERS MAXIMUM PROTECTION FOR CUTTING WHEELS</p>	 <p>QUICK ON THE JOB QUICK-ACTION RATCHETING HELPS YOU GET THE JOB DONE IN A SNAP. ITEM 1885385 ONLY.</p>
 <p>SPARE BLADE STORAGE A BONUS BLADE COMES WITH THE TOOL AND CAN BE STORED EASILY IN THE HANDLE. ITEMS 1885382 & 1885383 ONLY</p>	

Part code	Description	Diameter	Length	Width	Height	Weight
1885384	TC18138	1/8" - 1-3/8"	2-3/4"	1-3/4"	6-1/4"	1.4 lbs
1885385	TC18134	1/8" - 1-3/4"	3"	1-3/4"	7-7/8"	1.7 lbs

ACCESSORIES

Part code	Description
1885386	Small Tubing Cutter Wheels 2PK Fits Hilmor Tubing Cutters: 1885381, 1885382
1885387	Tubing Cutter Wheels 2PK Fits Hilmor Tubing Cutters: 1885383, 1885384, 1885385
21024TCD	Replacement Deburrer for 1885384 and 1885385



A STAINLESS STEEL BLADE GIVES YOU THE STRENGTH AND PRECISION FOR ANY CUT.

PLASTIC TUBE CUTTERS

We've cut out the unnecessary complexity so you can cut plastic. Hilmor's Plastic Tubing Cutter gets the job done with ease. Simple design and intuitive features allow you to get a handle on any cut.



RUGGED AND DURABLE

AN ERGONOMIC, CAST-ALUMINUM BODY AND HIGH-CARBON STEEL BLADE INCREASE LIFE AND DURABILITY.



COMFORTABLE GRIP

A RUBBERISED HANDLE MAKES IT EASIER TO USE IN WET AND DIRTY ENVIRONMENTS



EASY TO OPEN AND CLOSE

A CONVENIENTLY POSITIONED LOCKING LATCH ALLOWS FOR TRUE ONE-HANDED OPERATION

Part code	Description	Diameter	Length	Width	Height	Weight
1885388	PTC Plastic Tube Cutter	1-5/16" MAX OD	11"	5-1/2"	1-2/5"	13 oz

REPLACEMENT BLADE

Part code	Description
1885390	PTCRB Plastic TC Rep Blade



RATCHETING PLASTIC TUBING CUTTERS

1885393



RUGGED AND DURABLE
AN ERGONOMIC, CAST-ALUMINUM BODY AND HIGH-CARBON STEEL BLADE INCREASE LIFE AND DURABILITY.



COMFORTABLE GRIP
A RUBBERISED HANDLE MAKES IT EASIER TO USE IN WET AND DIRTY ENVIRONMENTS



EASY TO OPEN AND CLOSE
A CONVENIENTLY PLACED RELEASE BUTTON ALLOWS FOR TRUE ONEHANDED OPERATION, WHILE A LOCKING TAB SECURES THE BLADE IN PLACE.

Part code	Description	Diameter	Length	Width	Height	Weight
1885393	RPTC158	1-5/8" MAX OD	9"	1-1/8"	4-1/8"	1.0 lbs

REPLACEMENT BLADE

Part code	Description
1885394	RPTC158RB Rat TC Rep Blade

1885395



RUGGED AND DURABLE
AN ERGONOMIC, CAST-ALUMINUM BODY AND HIGH-CARBON STEEL BLADE INCREASE LIFE AND DURABILITY.



EASY TO OPEN AND CLOSE
A CONVENIENTLY PLACED RELEASE BUTTON ALLOWS FOR TRUE ONEHANDED OPERATION, WHILE A LOCKING TAB SECURES THE BLADE IN PLACE.

Part code	Description	Diameter	Length	Width	Height	Weight
1885395	RPPTC238	2-3/8" MAX OD	13-1/8"	1-1/3"	6"	2.5 lbs

REPLACEMENT BLADE

Part code	Description
1885396	RPTC238RB Rat TC Rep Blade

VACUUM GAUGE

SPECIFICATIONS
 UNITS: MICRONS, MBAR & MMHG

ACCURACY
 5% ±10 MICRONS (1 TO 1,000 MICRONS) AT 25°C
 20% (1,000 TO 5,000 MICRONS) AT 25°C

RESOLUTION
 1 MICRON (1 TO 2,000 MICRONS)
 100 MICRONS (2,000 TO 20,000 MICRONS)
 1000 MICRONS (20,000 TO 100,000 MICRONS)
 10000 MICRONS (100,000 TO 300,000 MICRONS)



COMPACT VACUUM GAUGE

The Hilmor Compact Vacuum Gauge is an all-in-one wireless micron gauge that is durably constructed for everyday use and abuse. An easy to read backlit display provides readings and the two button operation simplifies field use.



EASY TO READ

BACKLIT LCD MAKES READING IN THE DARK EASY.



CONVENIENT STORAGE

PROTECTIVE CASE KEEPS THE GAUGE SAFE AND QUICK TO GRAB.



ADDED VERSATILITY

FULL RANGE READINGS LETS YOU SEE THE PROGRESS RIGHT AWAY.



SUPERIOR PROTECTION

HANDLES 800 PSI MOMENTARILY IF A MISTAKE IS MADE.

Part code	Description	Length	Width	Height
CVG1200	CVG compact vacuum gauge	4.8"	2.2"	1.2"





THIS THERMOMETER IS THE FIRST IN THE INDUSTRY TO ATTACH TO ANY MANIFOLD.



DUAL READOUT THERMOMETER

Measuring system temperature requires multiple tools, and sometimes multiple trips to the truck. The Hilmor Dual Readout Thermometer was designed to change that. It's the industry's only manifold-compatible compact thermometer with two readings to make calculations simple. You can use it on any manifold. You can use it independently. But most important, you can use it to maximize efficiency. Sold with two K-style thermocouple clamps.

- 

MAKES CALCULATIONS EASIER
THE INDUSTRY'S ONLY MANIFOLD COMPATIBLE COMPACT THERMOMETER WITH TWO READINGS TO HELP SIMPLIFY THE CALCULATION OF SUPERHEAT AND SUBCOOL.
- 

SUPERIOR VERSATILITY
USE IT ON ANY GAUGE SET, OR REMOVE IT AND USE IT INDEPENDENTLY.
- 

READS TEMPERATURES QUICKLY
TWO EASY-TO-USE, K-STYLE TUBECLAMP THERMOCOUPLES GET YOU TO THE TEMPERATURE READING QUICKLY.

TWO THERMOCOUPLES INCLUDED BATTERIES BATTERY LIFE CONNECTION TYPE MEASUREMENT RANGE RESOLUTION ACCURACY OPERATING TEMPERATURE RANGE	1839108 TCC THERMOCOUPLE CLAMP AA X 1 (INCLUDED) 151 HOURS K TEMPERATURE -76°F TO 999.9°F .10° F/C +-2.0 C°/+3.6°F 0°C TO +50°C (LCD)
--	---

Part code	Description	Length	Width	Height	Weight
1839106	DROT2TCC DUAL READOUT THERMOMETER	1-3/4"	1-5/8"	3-7/8"	11 oz



Driven to perform. Everything about these screwdrivers says get work done. They're designed to last with a heattreated, chrome-plated shaft, yet they wouldn't dare strip out your screws.

**MORE TORQUE**

A SLIP-RESISTANT GRIP ALLOWS FOR MAXIMUM LEVERAGE.

**QUICK IDENTIFICATION**

EASY-TO-READ TIP MARKINGS ON THE HANDLE MAKE IDENTIFICATION QUICK AND EASY.

**RUGGED AND DURABLE**

DESIGNED TO LAST WITH A HEATTREATED, CHROME-PLATED SHAFT.

KEYSTONE TIP SCREWDRIVERS

Part code	Description	Shaft length	Tip type / size	Length	Width	Height	Weight
1891355	SDSLKTRS14112	1-1/2"	1/4"	3-1/2"	1-1/4"	1-1/4"	2 oz
1891352	SDSLKTSS144	4"	1/4"	8-1/8"	1"	1"	4 oz
1891356	SDSLKTRS144	4"	1/4"	8"	1-1/8"	1-1/8"	4 oz
1891358	SDSLKTRS5166	6"	5/16"	10-1/2"	1-1/4"	1-1/4"	6 oz
1891286	SDSLKTRS388	8"	3/8"	12-1/2"	1-3/8"	1-3/8"	8 oz

CABINET TIP SCREWDRIVERS

Part code	Description	Shaft length	Tip type / size	Length	Width	Height	Weight
1891287	SDSLCTRS3163	3"	3/16"	6-1/2"	1"	1"	3 oz
1891288	SDSLCTRS3166	6"	3/16"	9-1/2"	1"	1"	3 oz
1891289	SDSLCTRS146	6"	1/4"	10-1/4"	1"	1"	4 oz







TERMINAL BLOCK
SCREWDRIVER 4"
1891397

#1 PHILLIPS TIP
SCREWDRIVER 3"
1891290

**TERMINAL BLOCK
& PHILLIPS TIP
SCREWDRIVERS**

A unique screw calls for a unique screwdriver. The Terminal Block Screwdriver is one-of-a-kind with a heat-treated shaft and supercomfortable grip.

 <p>MORE TORQUE A SLIP-RESISTANT GRIP ALLOWS FOR MAXIMUM LEVERAGE.</p>	 <p>RUGGED AND DURABLE DESIGNED TO LAST WITH A HEATTREATED, CHROME-PLATED SHAFT.</p>
 <p>QUICK IDENTIFICATION EASY-TO-READ TIP MARKINGS ON THE HANDLE MAKE IDENTIFICATION QUICK AND EASY.</p>	 <p>SECURE FIT A MACHINED TIP ALLOWS FOR A BETTER FIT.</p>

TERMINAL BLOCK SCREWDRIVER

Part code	Description	Shaft length	Tip type / size	Length	Width	Height	Weight
1891397	SDTB4	4"	Terminal Block	7-1/8"	7/8"	1"	2 oz

PHILLIPS TIP SCREWDRIVERS

Part code	Description	Shaft length	Tip type / size	Length	Width	Height	Weight
1891290	SDPHRS13	3"	#1PH	6-1/2"	1"	1"	3 oz
1891391	SDPHRS2	1-1/2"	#2PH	3-1/2"	1-1/4"	1-1/4"	2 oz
1891392	SDPHRS24	4"	#2PH	8"	1"	1"	4 oz
1891393	SDPHRS27	7"	#2PH	11"	1"	1"	5 oz
1891394	SDPHRS36	6"	#2PH	10-1/2"	1-1/4"	1-1/4"	6 oz



INCLUDES STORAGE POUCH.

TIP MARKINGS FOR QUICK IDENTIFICATION.

PRECISION SCREWDRIVER SET

When the job calls for precision, reach for Hilmor. The Precision Screwdriver Set features machined tips and rotating heads. Plus, a convenient storage pouch keeps you organised.

- INCLUDES:
- 1/16" X 2" SLOTTED
 - #0 X 3" PHILLIPS
 - 3/32" X 3" SLOTTED
 - 1/8" X 4" SLOTTED
 - 1/8" X 6" SLOTTED



COMFORTABLE GRIP

OVER-MOLDED HANDLES REDUCE HAND FATIGUE AND WON'T SLIP OR TWIST.



MAXIMUM PRECISION

A ROTATING HEAD ALLOWS FOR PRECISE ADJUSTMENTS WHILE GIVING YOU GREATER CONTROL.



QUICK IDENTIFICATION

EASY-TO-READ TIP MARKINGS ON THE HANDLE MAKE IDENTIFICATION QUICK AND EASY.



STORAGE

POUCH INCLUDED FOR QUICK AND EASY STORAGE.

Part code	Description	Length	Width	Height	Weight
1891089	SDPS	10-1/4"	5"	1/8"	10 oz



5-PIECE
SCREWDRIVER SET
1891087

7-PIECE
SCREWDRIVER SET
1891088

SCREWDRIVER SETS

Tip markings on the handle for quick ID. Heat-treated shafts for extra durability. There are thousands of screwdrivers to choose from, but only one set says Hilmor. Available in 5-piece or 7-piece sets.

5-PIECE SET INCLUDES:

- #2 PHILLIPS TIP ROUND SHANK 4"
- 3/16" CABINET TIP ROUND SHANK 6"
- 1/4" CABINET TIP ROUND SHANK 6"
- 1/4" KEYSTONE TIP SQUARE SHANK 4"
- 5/16" KEYSTONE TIP ROUND SHANK 6"

7-PIECE SET INCLUDES:

- #1 PHILLIPS TIP ROUND SHANK 3"
- #2 PHILLIPS TIP ROUND SHANK 4"
- 3/16" CABINET TIP ROUND SHANK 3"
- 3/16" CABINET TIP ROUND SHANK 6"
- 1/4" CABINET TIP ROUND SHANK 6"
- 1/4" KEYSTONE TIP SQUARE SHANK 4"
- 5/16" KEYSTONE TIP ROUND SHANK 6"



MORE TORQUE

A SLIP-RESISTANT GRIP ALLOWS FOR MAXIMUM LEVERAGE.



QUICK IDENTIFICATION

EASY-TO-READ TIP MARKINGS ON THE HANDLE MAKE IDENTIFICATION QUICK AND EASY.



RUGGED AND DURABLE

RUGGED AND DURABLE DESIGNED TO LAST WITH A HEATTREATED, CHROME-PLATED SHAFT.



SECURE FIT

A MACHINED TIP ALLOWS FOR A BETTER FIT.

Part code	Description	Length	Width	Height	Weight
1891087	SD5PC	10-1/4"	1-1/4"	1-1/4"	1.4 lbs
1891088	SD7PC	10-1/2"	1-1/4"	1-1/4"	1.7 lbs



9 IN 1 MULTI-TOOL

When you've got a lot of jobs but not a lot of time, the 9 in 1 Multi-Tool from Hilmor can save the day. It features a slip-resistant grip for more torque and a thick-walled shaft for more durability.

BIT SIZES
 #1 & #2 PHILLIPS, 3/16" & 1/4" SLOTTED, #2 SQUARE, 1/4", 5/16", AND 3/8" NUT DRIVERS, AND VALVE CORE REMOVER.



RUGGED AND DURABLE

DESIGNED WITH THICK SHAFT WALLS FOR LONG LIFE AND LESS STRIPPING.



MORE TORQUE

A SLIP-RESISTANT GRIP ALLOWS FOR MAXIMUM LEVERAGE.

Part code	Description	Length	Width	Height	Weight
1839053	9IN1SV	7-1/4"	1-1/3"	1-1/3"	7 oz
1937819	MT9IN16	10-1/2"	1-1/8"	1-1/8"	10 oz

6 IN 1 STUBBY MULTI-TOOL

Small spaces come standard in HVAC/R. That's why you need the Hilmor 6 in 1 Stubby Multi-Tool. Its compact design fits right in, giving you the necessary torque to tighten or loosen a screw or nut.

BIT SIZES
 3/16" AND 1/4" SLOTTED, #1 AND #2 PHILLIPS, 1/4" AND 5/16" NUT DRIVERS.



SMALL SPACE CAPABLE

A COMPACT DESIGN ALLOWS FOR USE IN TIGHT SPACES.



MORE TORQUE

A SLIP-RESISTANT GRIP ALLOWS FOR MAXIMUM LEVERAGE.



SIMPLE SETUP

EASILY CHANGE BETWEEN SIX DIFFERENT DRIVERS - 3/16" AND 1/4" SLOTTED, #1 AND #2 PHILLIPS, 1/4" AND 5/16" NUT DRIVERS.

Part code	Description	Length	Width	Height	Weight
1891351	MTS	4-7/8"	1-1/4"	1-1/4"	3 oz.



RATCHETING 9 IN 1 MULTI-TOOL

A simple twist of the hand can drive a screw, nut or bolt in no time. Nine different bits are at your disposal. A ratcheting mechanism and an ergonomic rubber grip comes standard.

BIT SIZES

#1 & #2 PHILLIPS, 3/16" & 1/4" SLOTTED, #2 SQUARE, 1/4", 5/16", AND 3/8" NUT DRIVERS, AND VALVE CORE REMOVER.



RUGGED AND DURABLE

DESIGNED WITH A HIGH-TORQUE RATCHETING MECHANISM AND THICK SHAFT WALLS FOR LONG LIFE AND LESS STRIPPING.



MORE TORQUE

A SLIP-RESISTANT GRIP ALLOWS FOR MAXIMUM LEVERAGE.



SIMPLE SETUP

EASILY CHANGE BETWEEN FORWARD, REVERSE AND LOCKED POSITIONS.

FEATURES 9 DRIVING BITS, INCLUDING A VALVE CORE REMOVER.

Part code	Description	Length	Width	Height	Weight
1891259	MTR91	8-1/2"	1-1/4"	1-1/4"	12 oz

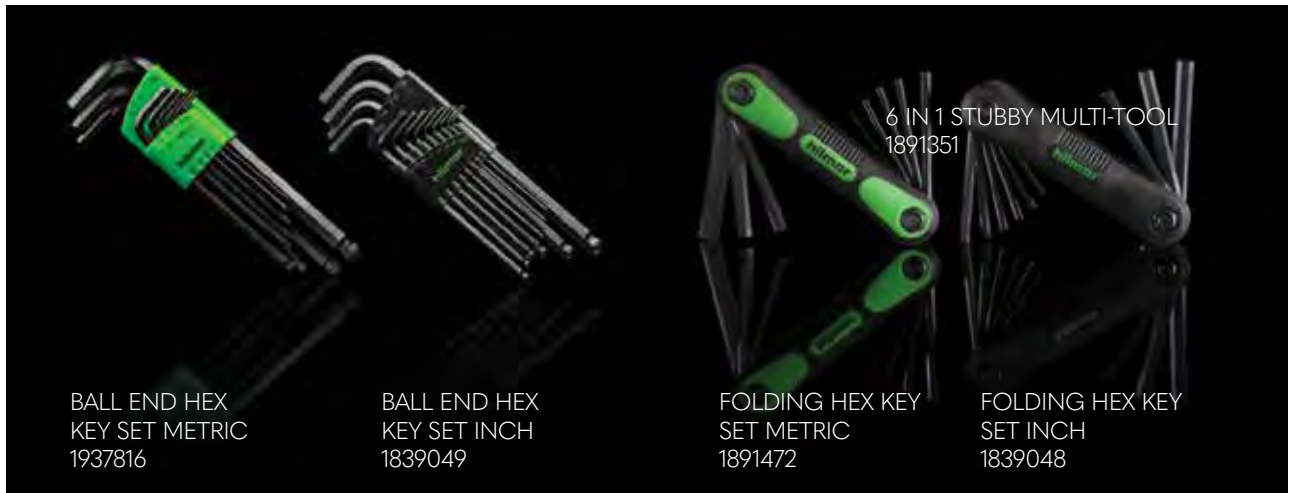

BALL END HEX KEY SET METRIC
1937816

BALL END HEX KEY SET INCH
1839049

FOLDING HEX KEY SET METRIC
1891472

FOLDING HEX KEY SET INCH
1839048

6 IN 1 STUBBY MULTI-TOOL
1891351

HKSS / HKSBEH HEX KEY SETS

Hex head screws have nowhere to hide. Hilmor Hex Key Sets have standard and metric sizes covered. They're slipresistant so you never lose your grip and always keep your cool.

HKSS sizes
.05", 1/16", 5/64", 3/32", 7/64", 1/8", 9/64",
5/32", 3/16", 7/32", 1/4", 5/16", 3/8"

HKSBEH sizes
1.5mm, 2mm, 2.5 mm, 3mm, 4mm, 5mm,
6mm, 8mm, 10mm

Part code	Description	Length	Width	Height	Weight
1839049	HKSS Ball End Hex Key Set inch	7-1/4"	2-3/4"	3/4"	13 oz
1937816	HKSBEH Ball End Hex Key Set metric	7"	2-1/2"	3/4"	12 oz

FOLDING HEX KEY SETS

You don't fold on the job. Luckily, this set does for easy, convenient storage. Available in inch and metric.

HKSS sizes
5/64", 3/32", 7/64", 1/8", 9/64", 5/32",
3/16", 7/32", 1/4"

HKSBEH sizes
1.5mm, 2mm, 2.5mm, 3mm, 4mm, 5mm,
6mm, 8mm

Part code	Description	Length	Width	Height	Weight
1839048	HKFS Folding Hex Key Set inch	4-1/4"	7/8"	1-5/8"	5 oz
1891472	HKFSM Folding Hex Key Set metric	4-1/4"	7/8"	1-5/8"	5 oz



DIGITAL ADJUSTABLE TORQUE WRENCH

Tightening to true torque when working on mini-splits is serious business. Under tightening could result in refrigerant leaks, while overtightening could mean burst tubing. That's why the Hilmor Digital Adjustable Torque Wrench is critical to perfecting torque time and time again. The 9 factory memory settings make it quick to set common torque values, while the digital display shows the amount of force applied to the flare nut. And if that didn't make the job easy enough, lights and buzzers illuminate and sound when the desired torque is achieved.



LIGHTEN YOUR LOAD

ADJUSTABLE JAW ELIMINATES THE NEED TO CARRY AROUND EXTRA HEADS.



EASY TO USE

NINE PROGRAMMABLE MEMORY SETTINGS ALLOW FOR QUICK ACCESS TO THE MOST COMMON TORQUE LEVELS.



PRECISE READINGS

DIGITAL ADJUSTMENTS HELP ENSURE TORQUE MEASUREMENT ACCURACY.



EXTRA CONFIDENCE

LED LIGHTS AND BUZZER INDICATE THAT DESIRED TORQUE HAS BEEN REACHED.

Part code	Description	Jaw capacity	Accuracy	Batteries	Length	Width	Weight
1963826	DAJTW	1/4" to 1-1/16" to accommodate up to 5/8" flare nuts	+ / 3%	AA (x2)	17"	2-3/8"	2 lbs



ADJUSTABLE WRENCHES

Take your pick of imperial or metric scales. They come standard on all of our Adjustable Wrenches. They're made to fit in your hand with ergonomic grips and made to last by Hilmar.



COMFORTABLE GRIP

OVER-MOULDED HANDLES REDUCE HAND FATIGUE AND WON'T SLIP OR TWIST.



ADDED VERSATILITY

GET TWO-IN-ONE CAPABILITIES WITH BOTH INCH AND METRIC SCALES.

Part code	Description	Sizes	Jaw capacity (up to)	Length	Width	Height	Weight
1885369	AW6	6"	1"	6-3/8"	1-3/4"	1/2"	6 oz
1885370	AW8	8"	1-1/8"	8-1/4"	1"	5/8"	12 oz
1885421	AW10	10"	1-1/4"	10"	2-5/8"	3/4"	1.1 lbs
1885422	AW12	12"	1-1/2"	12-1/8"	2-7/8"	3/4"	1.7 lbs

AIR SOURCE HEAT PUMPS

FLEXIBLE CONNECTION HOSES



• THE 28MM HOSE IS SLEEVED WITH A STAINLESS STEEL BRAID FOR ADDED PROTECTION



SEE PAGE 101



• NO INSULATION CAN RESULT IN A HEAT LOSS OF UP TO 158W/M

- PRE-INSULATED WITH 19MM THICK PVC COATING
- 1" AND 1-1/4" MALE OR FEMALE BSP THREAD FITTING AVAILABLE
- 28MM COMPRESSION FITTING SUITABLE FOR MOST AIR SOURCE HEAT PUMPS



QUICK-ADJUSTING TONGUE & GROOVE PLIERS

We've made an adjustment to standard pliers. Our Quick-Adjusting Tongue and Groove Pliers feature a simple push button to give you a quick precision grip on pipes, fasteners and more.

- 

SIMPLE SIZING
A PUSH BUTTON ALLOWS FOR QUICK ADJUSTMENTS WHILE MULTIPLE GROOVES GUARANTEE PRECISE POSITIONING.
- 

COMFORTABLE GRIP
OVER-MOULDED HANDLE REDUCES HAND FATIGUE AND WON'T SLIP OR TWIST.
- 

STRONG HOLD
MACHINED JAWS INCREASE GRIP ON THE MATERIAL EVERY TIME.

Part code	Description	Sizes	Jaw capacity (up to)	Length	Width	Height	Weight
1890996	PBTGP8	8"	1-1/2"	8-1/4"	5/8"	1-3/4"	9 oz
1890998	PBTGP12	12"	2-3/16"	12-1/4"	3/4"	2-1/2"	1.4 lbs



PLIERS

LINEMAN'S PLIERS



STAYS SHARP

A LASER-HARDENED CUTTING EDGE WILL STAY SHARPER FOR LONGER.



STRONG HOLD

CROSS-CUT KNURLED JAWS INCREASE GRIP ON THE MATERIAL EVERY TIME.



COMFORTABLE GRIP

OVER-MOLDED HANDLES REDUCE HAND FATIGUE AND WON'T SLIP OR TWIST.

Grab. Twist. Cut. Repeat. Over and over again. A laser-hardened cutting edge stays sharp longer, and crosscut knurled jaws guarantee a strong grip time after time. Hilmor Lineman's Pliers will last.

Part code	Description	Sizes	Length	Width	Height	Weight
1885399	LP85	8-1/2"	8-3/4"	2"	7/8"	13 oz.
1885411	LP95	9-1/2"	9-1/2"	2-1/4"	7/8"	1.0 lbs.

LONG NOSE PLIERS



STAYS SHARP

A LASER-HARDENED CUTTING EDGE WILL STAY SHARPER FOR LONGER.



STRONG HOLD

CROSS-CUT KNURLED JAWS INCREASE GRIP ON THE MATERIAL EVERY TIME.



COMFORTABLE GRIP

OVER-MOLDED HANDLES REDUCE HAND FATIGUE AND WON'T SLIP OR TWIST.

It's tough to beat a good pair of pliers. A laser-hardened cutting edge, crosscut knurled jaws and over-molded handles make Hilmor Long Nose Pliers pretty darn tough to beat.

Part code	Description	Sizes	Length	Width	Height	Weight
1885397	LNP6	6"	6-7/8"	2-1/8"	5/8"	4 oz
1885398	LNP8	8"	8-5/8"	2-1/8"	3/4"	8 oz

DIAGONAL CUTTING PLIERS



STAYS SHARP

A LASER-HARDENED CUTTING EDGE WILL STAY SHARPER FOR LONGER.



COMFORTABLE GRIP

OVER-MOLDED HANDLES REDUCE HAND FATIGUE AND WON'T SLIP OR TWIST.

What's our angle? To make a great pair of pliers. The Diagonal Cutting Pliers stay sharp as a samurai sword with a laser-hardened cutting edge.

Part code	Description	Sizes	Length	Width	Height	Weight
1885412	DCP6	6"	6-3/4"	2-1/8"	3/4"	4 oz
1885363	DCP8	8"	8"	2-1/8"	3/4"	12 oz

CRIMPING TOOL



STAYS SHARP

A LASER-HARDENED CUTTING EDGE WILL STAY SHARPER FOR LONGER.



COMFORTABLE GRIP

OVER-MOLDED HANDLES REDUCE HAND FATIGUE AND WON'T SLIP OR TWIST.

CAPACITY	
WIRE	10-22AWG
INSULATED TERMINALS	10-22AWG
NON-INSULATED TERMINALS	10-22AWG

Crimp. Cut. We've got you covered. The Hilmor Crimping Tool handles both insulated and non-insulated terminals. Over-molded handles and a hardened cutting edge come standard, too.

Part code	Description	Sizes	Length	Width	Height	Weight
1885429	FC10	10"	9-7/8"	2-1/4"	3/4"	1.1 lbs.

REFRIGERANT RECOVERY PLIERS



Smart features that save refrigerant and time. Our Refrigerant Recovery Pliers make evacuating equipment quick and easy. The pliers have a valve on one end with a sharp needle point and a gasket to keep all recovered refrigerant in the system and prevent leaks.

Part code	Description	Sizes	Weight
1937677	RRP	1/4" to 1-1/8"	13 oz

**RUGGED AND DURABLE**

PLIERS ARE BUILT TO LAST, MANUFACTURED FROM HIGH-GRADE HEAT-TREATED ALLOY STEEL FOR DURABILITY.

**SECURELY LOCKS IN PLACE**

A CLASSIC TRIGGER RELEASE IS DESIGNED TO PROVIDE A TIGHT CONNECTION DURING RECOVERY, REDUCING THE POTENTIAL FOR A LEAK.

**ADDED VERSATILITY**

DESIGNED TO QUICKLY LOCK ON TO AND PIERCE REFRIGERANT LINE FROM 1/4" TO 1-1/8" IN DIAMETER, LEAVING BOTH HANDS FREE TO DO OTHER WORK.

**PRECISION ADJUSTMENTS**

ADJUSTING SCREW IN THE HANDLE ALLOWS FOR QUICK AND PRECISE PRESSURE CHANGES BETWEEN DIFFERENT TUBING DIAMETERS.

WIRE STRIPPERS



The Hilmor Wire Strippers feature easy-to-read size markings, which means you can strip wires with ease and without damage. Electrical work is no laughing matter, and these Wire Strippers are no joke.



COMFORTABLE GRIP

OVER-MOLDED HANDLES REDUCE HAND FATIGUE AND WON'T SLIP OR TWIST.



QUICK ID

EASY-TO-READ SIZE MARKINGS ON THE JAWS MAKE IDENTIFICATION SIMPLE.



BOLT CUTTING

CUTS 4-40, 5-40, 6-32, 8-32, 10-24, 10-32 BOLTS AND SCREWS TO DESIRED SIZE.*1885424 ONLY.

Part code	Description	Sizes	Capacity	Length	Width	Height	Weight
1885426	WS7	7"	10-20AWG	7-1/4"	2-1/8"	5/8"	6 oz
1885427	WS6	6"	10-20AWG	6-1/2"	2-1/4"	5/8"	5 oz.
1885424	WS8	8"	10-22AWG	8"	2-5/8"	5/8"	8 oz.

DEBURRING

DEBURRING TOOLS



Whether they're inside or outside, copper or plastic, Hilmor Deburring Tools can smooth things over. With steel blades, the standard Deburrer works flawlessly on OD tubing from 1/4" to 1-5/8". And our Pocket Size Deburring Tool lets you put your silkysmooth signature on even the smallest pieces of tubing.

Part code	Description	Sizes	Length	Width	Height	Weight
1839052	DBUR	1/4" to 1-5/8"	2-3/8"	2-1/8"	2-1/8"	2 oz
1891258	DBURPS	1/4" and up	5-1/2"	3/8"	3/8"	7 oz

FIN TOOLS

FIN STRAIGHTENING TOOLS



A condenser should work as efficiently as you. These tools make it easy to remove debris and straighten fins.

Part code	Description	Sizes	Length	Width	Height
T-100	Fin tool kit	8, 9, 10, 11, 12, 14 FPI	5-3/4"	2"	1-1/2"



FOLDING UTILITY KNIFE

Hilmer's Folding Utility Knife stands up to the test with an all-metal body. It's your new knife.



YOU WON'T FOLD ON THE JOB. WITH A LINER LOCK, THIS KNIFE WON'T EITHER. UNTIL YOU WANT IT TO.



RUGGED AND DURABLE

AN ALL-METAL BODY INCREASES LIFE AND DURABILITY.



SECURELY LOCKS BLADE

A BLADE-LOCKING MECHANISM PREVENTS THE BLADE FROM COMING OUT DURING USE.



ONE-HANDED OPERATION

A LINER-LOCK FOR ONE-HANDED OPERATION AND EXTRA SAFETY.



SUPERIOR VERSATILITY

A BUILT-IN WIRE-STRIPPING CHANNEL FOR UP TO 10-GAUGE WIRE IS THERE WHEN YOU NEED IT.



BELT CLIP

A BELT CLIP KEEPS KNIFE CLOSE FOR EASY ACCESS.

Part code	Description	Length	Width	Height	Weight
1885433	UKHF	1-1/2"	3/4"	4"	5 oz.

REPLACEMENT KNIFE BLADES

Replacement blades are compatible with standard utility knife blades.



THREE ZIPPERED POUCHES AND TWO PADDED SIDE POCKETS PROVIDE SAFE STORAGE FOR YOUR METER.

TOOL CENTRE BAG

The Hilmor Tool Center Bag is your total tool storage solution. It includes 24 exterior and interior pockets and three zippered pouches so you can store your tools safely and find them quickly.

EXTRA FEATURES
CLEAR VINYL ID WINDOW POCKET;
SHOULDER STRAP; COVER FLAP



KEEP ORGANISED

24 POCKETS AND THREE ZIPPERED POUCHES.



SECURE STORAGE

STOW YOUR METER AWAY SAFELY IN EITHER OF THE TWO PADDED POCKETS ON THE EXTERIOR SIDES OF THE TOTE.



HELPS WITH THE HEAVY LIFTING

THIS BAG HAS ROOM FOR MULTIPLE TOOLS AND IS TESTED UP TO 50 LBS. THE PADDED SHOULDER STRAP MAKES CARRYING MORE COMFORTABLE.



RUGGED AND DURABLE

DESIGNED TO LAST WITH A HARD PLASTIC, WATER-RESISTANT BOTTOM AND A PADDED ALUMINIUM CARRYING HANDLE.

Part code	Description	Pockets interior	Pockets exterior	Length	Width	Height	Weight
1839079	TCB	13; 18 Tool Loops	11	13-1/2"	8-1/2"	9"	4.5 lbs



A METAL LOOP GIVES YOU AN EASY WAY TO TRANSPORT YOUR MANIFOLD.

TWO PADDED, ZIPPERED SIDE POCKETS PROVIDE SAFE STORAGE FOR YOUR METER.

BACKPACK TOOL BAG

The Hilmor Backpack Tool Bag is your jobsite sidekick with 19 exterior and interior pockets. Its sturdy rubber, water-resistant bottom means rain or shine, the contents inside won't be damaged. And while it's spacious enough to hold up to 50 lbs., padded shoulder straps and a back air vent make hauling it a little more comfortable and leave your hands free to safely climb a ladder.

19 EXTERIOR AND INTERIOR POCKETS ALLOW YOU TO STORE TOOLS SAFELY AND FIND THEM QUICKLY.



SECURE STORAGE

STOW YOUR METER AWAY SAFELY IN EITHER OF THE TWO PADDED ZIPPER POCKETS ON THE EXTERIOR SIDES OF THE TOTE.



SUPERIOR VERSATILITY

HANG YOUR MANIFOLD FROM THE BAG'S METAL LOOP FOR EASY TRANSPORT TO THE JOBSITE.



HELPS WITH THE HEAVY LIFTING

THIS BAG HAS ROOM FOR MULTIPLE TOOLS AND IS TESTED UP TO 50 LBS. THE PADDED SHOULDER STRAPS AND AIR VENT BACK MAKE CARRYING MORE COMFORTABLE.

Part code	Description	Pockets interior	Pockets exterior	Length	Width	Height	Weight
1839080	BKB	11	8	6"	14"	16"	4.5 lbs

WARRANTY - REPAIR

BOSCH WARRANTY & REPAIR

BOSCH PROMAX[®] ROBINAIR

OUR SERVICE CENTRE WILL UNDERTAKE...

- Repairs to **PROMAX** and **BOSCH** recovery machines
- Repairs and servicing to **ROBINAIR** vacuum pumps
- **TIF** scale calibration and certificate (£60 charge)

STANDARD RETURN PROCEDURE...

- Send PO to our sales email (sales@diversitech.com)
- Fill out the form (page 2) and send it back with the machine
- Send the machine back to our address in Nottingham, quoting PO number
- The machine will be inspected, and a repair quote sent to the wholesaler, along with invoice for £40
- On receipt of the order for the repair quote, the machine will be repaired and returned

WARRANTY RETURN PROCEDURE...

Our standard warranty is one year from date of purchase unless stated differently (Some leak detectors are 2 years)

- Send the machine back to our address in Nottingham with a copy of proof of purchase and date
- Fill out the attached form and send it back with the machine
- The machine will be inspected
- It will be repaired or replaced at the discretion of DiversiTech International
- The machine will be returned to the customer with no repair costs

IMPORTANT: All units will be kept for a maximum of 60 days from customer quotation date. After this date, if no response has been received, the unit will be discarded.

Note: If you are making a warranty claim, proof of purchase is required.

A charge of £40 will be made prior to the inspection of any unit (excluding warranty returns).

Vacuum pumps must be drained of oil prior to shipping. Heavily contaminated units (oil) will incur a additional cleaning charge.

Recovery machines need to have both valves fully open and relieved of pressure prior to shipping. This should be done by a competent engineer.

Please note: Warranty claims are returned to DiversiTech International at the customer's expense. DiversiTech International will assess your claim, and provide feedback after the unit has been inspected and tested. Repair requests will be assessed, and an individual quote will be provided. A repair request will incur a charge.

INDEX BY ITEM

ITEM	PAGE	ITEM	PAGE	ITEM	PAGE
AC DYE	63	CLOTHS	71, 86	FLARING - HILMOR	208
AC SHUT OFF SWITCH	23	CLOTHS - WYPALL	66, 89	FLARING AND SWAGING - IMPERIAL	183
ACCESS FITTINGS	49	COACH SCREWS	129	FLARING AND SWAGING - SPIN	175
ACID ELIMINATORS	68	CONDENSATE BRAIDED HOSE	22	FLAT / FORM A WASHERS	127
ACID TEST KITS	68	CONDENSATE BYPASS VALVE	82	FLAT PLATES	123
ADJUSTABLE SUPPORT FOOT	96	CONDENSATE COP	23	FLEXI FIX CLAMP	98, 113
AEROSOLS	57	CONDENSATE DRAIN ADAPTORS	21, 83	FLEXI LITE SLAB KIT	38, 95
ANCHOR BOLTS	130	CONDENSATE MINI PUMPS	17	FLEXI PATCH	68
ANTI-FREEZE VALVES	97	CONDENSATE MINI PUMPS	17	FLEXIBLE CONNECTION HOSES	101
ANTI-VIBRATION MOUNTING BOLTS	28, 98	CONDENSATE MINI PUMPS	18	FLOOR BRACKET	29, 98
ANTI-VIBRATION MOUNTING STRIPS	37	CONDENSATE MINI PUMPS	17	FOAM SEALANT	67, 88
AUDIBLE ALARM	21, 83	CONDENSATE NEUTRALISER PUMPS	78	FUCHS RENISO PAG	140
AXIAL FAN MOTORS	8	CONDENSATE PAN TREATMENT	68	FUCHS RENISO TRITON	138
BACK PLATES	44, 132	CONDENSATE TANK PUMPS	15	FUSED SPUR SWITCHES	87, 134
BALL VALVES	97	CONDENSATE TANK PUMPS	15, 16	GAUGES AND REFRIGERANT HOSES	196, 202
BASE AND EXTENDER FRAMES	110	CONDENSATE TANK PUMPS	15	GRIP FIT CLAMPS	43
BASKET TRAY	126	CONDENSATE TANK PUMPS	15	H-FRAME KITS	111
BASKET TRAY CEILING BRACKET	126	CONDENSATE TRAYS	29, 95	HEAT BARRIER SPRAY	66, 89
BASKET TRAY QUICK CONNECT	126	CONDENSING GUARDS - METAL	24, 103	HEX KEYS	224
BASKET TRAY WALL SUPPORT BRACKET	126	CONDENSING GUARDS - WOOD	24, 103	HEX SETS	129
BEAM G CLAMP	122	COPPER FITTINGS	50	HEXAGONAL NUTS	128
BOILER CONDENSATE TANK PUMP	20, 78	COPPER SPUN DRIERS	59, 89	HIGH TEMPERATURE TANK PUMP	20, 79
BRACKETS	25, 26, 27, 28, 94	CORE REMOVER	70	HINGED LINED PIPE CLAMPS	45, 133
BRASS FITTINGS	48	CORRUGATED HOSE	22	HOP OVERS - FLEXI	119
BRAZING GAS	58, 87	CUSHION CLAMPS	43	HOSE CLAMP	23
CABLE TIE CLIPS	47	CUSTOM FRAMES - FLEXI	118	HOSE CONNECTOR	23
CABLE TIES / MOUNTS	135	CUSTOM PLATFORMS / WALKWAYS	120	INSPECTION MIRRORS	59
CABLE TRAY REDUCER	125	DAIRY CABINET PUMPS	6	INSULATION	102
CABLE TRAY FLAT BENDS	124	DIGITAL TORQUE WRENCH	225	INSULATION	101
CABLE TRAY HANGER	125	DIGITAL VACUUM GAUGE	171, 216	INSULATION - THROUGH HE WALL	102
CABLE TRAY INTERSECTION	125	DIVERSI-BOND	88, 99	INSULCLIPS	46
CABLE TRAY STAND OFF BRACKET	125	DIVERSI-FLUSH	58	ISO-CUBE ANTI-VIBRATION PAD	40
CABLE TRAY TEES	124	DRAIN DAWG	23	ISOLATORS	10, 98, 134
CABLE TRAYS	124	DRAIN KAT	23	ISOLATORS	10, 98, 134
CABLES	135	DRAINGUN	58, 87	K-KLAMPS	44
CANTILEVER ARMS	28	DROP IN ANCHORS	131	LEAK ARMOR	64
CASSETTE ADAPTORS	21	DUAL READ OUT THERMOMETERS	217	LEAK DETECTION SPRAY	106
CHANNEL 4-HOLE CONNECTORS	123	ELECTRONIC LEAK DETECTORS	158	LEAK DETECTOR SPRAY	66
CHANNEL CLAMP	122	EVA MOUNTING PADS	40	LEAK DETECTORS - ELECTRONIC	106, 160
CHANNEL CLIPS	46	EVAPORATOR TRAY	6	LINE PIERCING VALVES AND TOOLS	69
CHANNEL U BRACKETS	123	EYE BOLTS	130	LINE TAP VALVES	70
CHANNEL WING FITTING	122	FAN BLADE - BLOWER	9	LIQUID LOW SIDE CHARGER	187
CHANNEL Z BRACKETS	123	FAN BLADE - SUCKER	9	LONG SPRING CHANNEL NUTS	128
CHEMICALS - AEROSOL	57, 106	FAN GUARD	9	LOOSE BOLT SHIELD ANCHOR	130
CHEMICALS - G2G RANGE	56, 106	FAN GUARD	9	MAGNETIC DRIVE PUMPS	75
CHEMICALS - PRO RANGE	56, 106	FAN RING	9	MANIFOLDS	192
CLEAR VINYL HOSE	22	FIN TOOLS	60, 232	MATS	71, 86
CLEAR VINYL HOSE	22	FIX PACKS - FLEXI	113	MINI FOOT	114

INDEX

ITEM	PAGE	ITEM	PAGE	ITEM	PAGE
MODULAR FRAMES - FLEXI	117	SEALING COMPOUND - DIVERSI-GUM	67, 88, 99	VACUUM PUMP OIL - ROBINAIR	138, 170
MOUNTING BLOCKS	37	SHAKE PROOF WASHERS	127	VACUUM PUMPS - A3	168
MULTI-PURPOSE OIL	66	SHORT SPRING CHANNEL NUTS	128	VIBRATION ABSORBER	7
MULTI-TOOLS	222	SILICONE SEALANTS	67, 88, 99	WALL AIR CONDITIONER	42
NITROGEN PURGE AND BRAZING TOOL	59	SLOTTED CHANNEL	122	WALL PLUGS	129
NON-RETURN CHECK VALVE	21, 83	SOAK AWAY	100	WALLKWAY MAT	114
NON-RETURN CHECK VALVE	21, 83	SOAKAWAY KIT	82	WEDGE NUTS	128
NON-RETURN CHECK VALVE	21, 83	SOCKET BOLTS	130	WINDOW BRACKETS	123
OILS AND CLEANERS	63	SPRAYERS	57	WIRE STRIPPERS	231
PARTS WASHER PUMPS	74	SPRAYERS	57	WRENCHES	186, 226
PARTS WASHER PUMPS	74	SPRAYERS - COILJET	189		
PENNY WASHERS	127	SQUARE PLATE WASHERS	127		
PINCH OFF TOOLS	186	STEP OVERS - FLEXI	119		
PIPE AND INSULATION CLAMP	7	STUD CONNECTORS	129		
PIPE AND INSULATION CLAMP	7, 133	STUDDING CAPS	124		
PIPE AND INSULATION CLAMP	7, 133	STUDDING CLIPS	47		
PIPE AND INSULATION CLAMP	7, 133	SUBMERSIBLE PUMP	74, 81		
PIPE AND INSULATION CLAMP	7, 133	SUPER SEAL LEAK	63		
PLAIN CHANNEL NUTS	128	SUPPORT FOOT - FLEXI	96, 112, 113		
PLASTER BOARD SCREWS	129	SWAGING - HILMOR	209		
PLASTIC END CAPS	124	SYNTHETIC REFRIGERATION OIL	11		
PLASTIC PIPE FITTINGS	90	TANGENTIAL FAN MOTORS	8		
PLASTIC PIPE FITTINGS	91	TAPES	71, 86, 101		
PLASTIC TUBE CUTTERS	214	TEK SCREWS	129		
PLIERS	227	THREAD SELEANT - PRO TITE	67		
POOL COVER PUMP	74, 81	THREADED ROD HANGERS	43		
PORTABLES	41, 42, 84, 85	THREADED RODS	124		
PRESSURE RELIEF TANK PUMP	20, 79	TOOLS BAGS	185, 234		
PROTECTION FLEECE	113	TOOLS STORAGE	185, 234		
PROTECTIVE HOUSING	10	TORCHES	61, 86		
PURLING CLIPS	123	TORCHES	61, 86		
PUSH FIT CONNECTORS	65	TRUNKING - INABA DENKO 140	104		
QUAD FRAMES - FLEXI	116	TRUNKING - ARTIPLASTIC 140	104		
QUICK SLING	39	TRUNKING - INABA DENKO 75/100	30		
RADIATOR DYE	63	TRUNKING - SPEEDICHANNEL 70/105	35		
REAMING AND DEBURRING	185, 186, 232	TRUNKING - SPEEDIDUCT 150	105		
RECOVERY MACHINES	148	TUBE BENDERS - HILMOR	203		
RECOVERY MACHINES	150, 152, 153	TUBE BENDERS - IMPERIAL	179		
REFRIGERANT RECOVERY TOOL	69, 230	TUBE CUTTERS - HILMOR	212		
REMOTE CONTROL - UNIVERSAL	42	TUBE CUTTERS - IMPERIAL	176		
ROOFING NUTS	128	TUBE EXPANDER - HYDRAULIC	174		
RUBBER ANTI-VIBRATION PAD	40	TWIN FAST SCREWS	129		
RUBBER AVM PAD	37	TWIN FRAMES - FLEXI	115		
RUBBER LINED PIPE CLAMPS	45, 132	ULTRALITE SLAB	38		
SCALES - REFRIGERANT WEIGHING SCALES	162	UNIVERSAL MULTI-FIT FAN MOTORS	8		
SCREWDRIVERS	218	UNLINED CLAMPS	131		
SEAL-SEALING PIPE ADAPTORS	21, 83	UTILITY KNIFE	233		

ENGINEER ON CALL

TELEPHONE



DiversiTech International Ltd.
2 Thane Road, Power Park, Nottingham NG7 2AA United Kingdom
T: +44(0)115 900 5858 E: sales@diversitech.com W: www.diversitech.global