

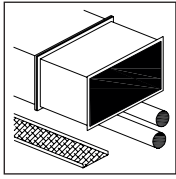

EVERYDAY



## FLEXI H-FRAME KITS

H-FRAME KITS TO SUPPORT DUCTS, PIPES AND ELECTRICAL CONTAINMENT

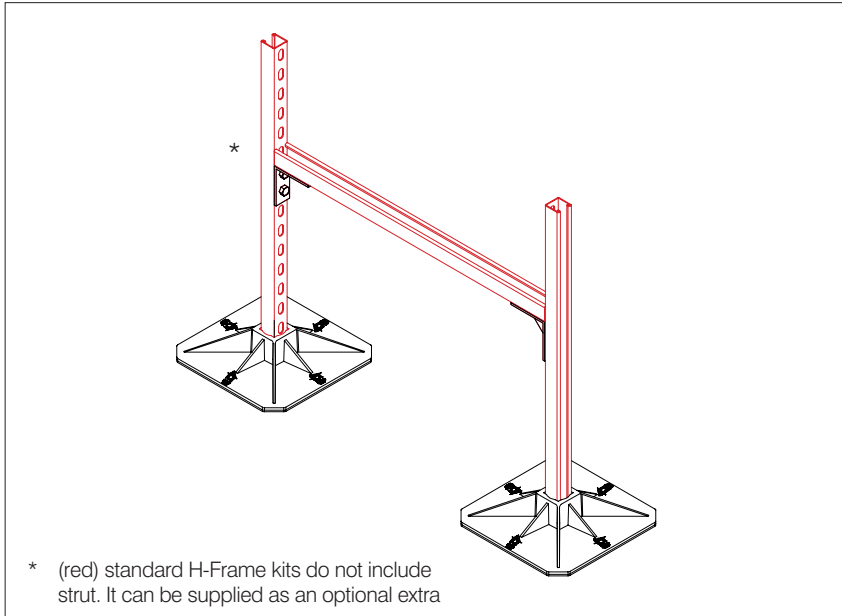

\* (red) standard H-Frame kits do not include strut. It can be supplied as an optional extra



## FEATURES & BENEFITS

- Non-penetrative support
- Flexible design to accommodate late design changes
- Fast and simple installation
- Hot-dip galvanised bracketry
- Rubber mats adhered to feet (320mm & 500mm feet only)
- The kit comes supplied in a box
- Full AutoCAD drawing support
- Load management calculations available
- Available as 305mm or 320mm for lighter weight services, or 500mm option for heavy-duty applications



LIGHT

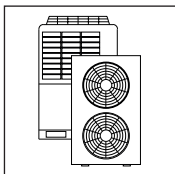

HEAVY

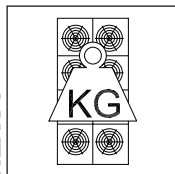

SOLAR

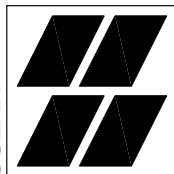

ACCESS

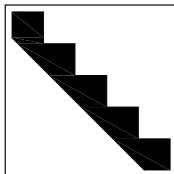

riba  
product  
selector

NBS Plus

### FLEXI-EVERYDAY Flexi H-Frame Kits

The DiversiTech International sales team are available to answer your questions or queries on this product. Our experts are waiting for your call +44 (0)115 900 5858 or if you prefer send an email to [sales@flexisupportsystems.co.uk](mailto:sales@flexisupportsystems.co.uk) or visit [www.flexisupportsystems.co.uk](http://www.flexisupportsystems.co.uk)

**DIVERSITECH**<sup>®</sup>  
INTERNATIONAL



## ■ FLEXI H-FRAME KITS

Our H-Frame kits offer the installer full flexibility by providing a solution where they can supply their own strut to suit their installation requirements. The H-Frame Kits are supplied with a pair of either 305mm feet, 320mm feet, (these smaller sizes are most widely used in the majority of installations), or our larger 500mm foot version kit. All kits are supplied with hot-dip galvanised angle brackets, together with all the necessary fixings to assist the installer, in a low cost, versatile and fast assembly solution on site. Complete strut assembled frameworks (H-frame kits where the strut is also supplied), are available upon request.

### Typical installation

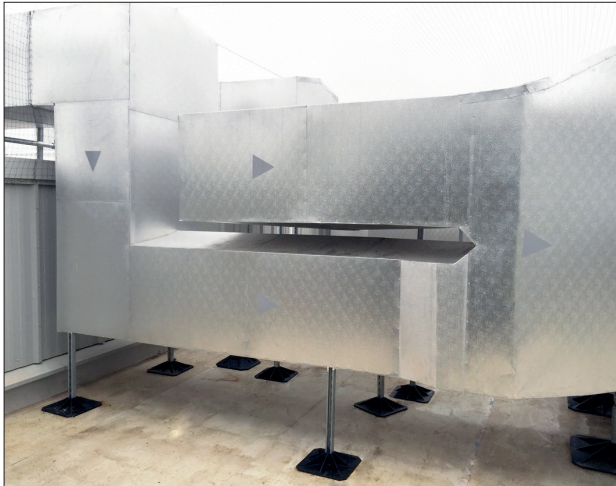

### What's in the box



Part code - F-HF-320 (shown above)

## ■ APPLICATION

- Suitable for everyday installation of ductwork, including associated attenuators. Small to medium-sized flow and return pipework, and electrical containment, e.g. cable trays or cable ladders.

## ■ WHAT OUR SERVICE OFFERS YOU

- Quotations on request
- Full Auto-CAD drawing support
- Site support and site surveys
- Load management calculations
- Over 25 years experience in flat roof design, and providing support systems to building services
- Fast delivery
- Experienced in-house technical staff

## ■ MATERIAL SPECIFICATION

- Foot - 305mm square, UV Stabilised 100% PVC
- Mat - (320mm & 500mm) 100% natural rubber, (mat is adhered to the feet) (305mm) 100% super soft PVC adhered to foot (prevents damage to PVC waterproof membranes, no fleece required)
- Fixings - M10 ZP sets, washers and spring nuts
- Angle brackets - mild steel, hot-dip galvanised BS EN ISO 1461:2009
- These products are supplied boxed. Kit does NOT include strut (frame) metalwork

Code	Description	Foot size	Safe working load*	Weight
F-HF-305	Flexi H-Frame Kit - 2 square block feet with fittings	305mm x 305mm	150kg	2.8kg
F-HF-320	Flexi H-Frame Kit - 2 square block feet with fittings	320mm x 320mm	250kg	4kg
F-HF-500	Flexi H-Frame Kit - 2 square block feet with fittings	500mm x 500mm	600kg	13kg

\* As the strut is not supplied with the kit, the maximum load is guide only

### Specification Extract

Dual/pipe/tray services will be supported on Flexi Everyday H-frame kits utilising (add required foot size) and with adhered rubber mats. Contact DiversiTech: Tel: +44(0)115900 5858

**FLEXI-EVERYDAY**  
Flexi H-Frame Kits

The DiversiTech International sales team are available to answer your questions or queries on this product. Our experts are waiting for your call +44 (0)115 900 5858 or if you prefer send an email to [sales@flexisupportsystems.co.uk](mailto:sales@flexisupportsystems.co.uk) or visit [www.flexisupportsystems.co.uk](http://www.flexisupportsystems.co.uk)

**DIVERSITECH**®  
INTERNATIONAL