

HVAC & R PRODUCT GUIDE

2023



#thediversitechway

DIVERSITECH[®]
INTERNATIONAL



Everything you need from our wide range of products to make installation easier



If it is in our extensive range of Easy-Fit products (from brackets to protective guards) - it is EASY-to-FIT



From chemicals through to leak detection dyes, DiversiTech International covers all your needs

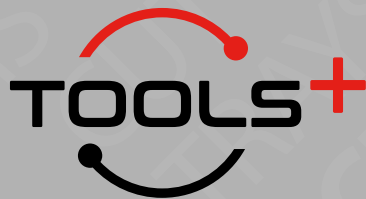

A full range of hand tools including BOSCH, Imperial, Spin and Hilmor



Our comprehensive range of products that provide a simplistic and cost-effective mounting solution

DIVERSITECH INTERNATIONAL

ABOUT US.....	4
WARRANTY.....	XX
INDEX (PRODUCT NAME).....	XX
INDEX (PART CODE).....	XX

REFRIGERATION

5

PUMPS.....	6
VIBRATION ABSORBER / CLAMP.....	7
FAN MOTORS.....	8
ISOLATORS.....	10
REFRIGERATION OIL [FUCHS].....	11

AIR CONDITIONING

17

CONDENSATE PUMPS & ACCESSORIES...19	
HIGH TEMPERATURE PUMPS.....	22
ADAPTORS.....	24
HOSE & CLAMPS.....	24
GUARDS.....	26
BRACKETS.....	27
TRAYS.....	31
TRUNKING.....	32
MOUNTING.....	38
PORTABLES.....	42
CLAMPS & CLIPS.....	43
BRASS & ACCESS FITTINGS.....	49
COPPER FITTINGS.....	50
SERVICE & MAINTENANCE.....	56
TOOLS.....	59
TORCHES.....	61
AUTOMOTIVE.....	63
SUPERSEAL.....	64
LUBRICANTS & DYES.....	67
ACCESSORIES.....	68/76
LINE PIERCING VALVES & TOOLS.....	71
PRO-FIT.....	72
TAPES, CLOTHS AND MATS.....	75

OTHER PUMPS

77

INDUSTRIAL PUMPS.....	78
MAGNETIC DRIVE PUMPS.....	79

BOILER & HEATING

81

BOILER CONDENSATE PUMPS.....	82
HIGH TEMPERATURE & PRESSURE RELIEF PUMPS.....	83
CONDENSATE NEUTRALISERS.....	84
DRAINAGE PUMPS.....	85
SOAKAWAY AND BYPASS VALVE.....	86
CONDENSATE PUMP ACCESSORIES.....	87
PORTABLES.....	88
INSULATION.....	88
SWITCHES & ISOLATORS.....	89
SERVICE & MAINTENANCE.....	89
TORCHES.....	90
TAPE.....	90
ACCESSORIES.....	91
PLASTIC PIPE FITTINGS.....	93

AIR SOURCE HEAT PUMPS

95

INSTALLING.....	96
CONNECTING.....	101
INSULATING.....	102
PROTECTING.....	103
MAINTAINING.....	105

FLEXI SUPPORT SYSTEMS

107

FLEXI BASE & EXTENDER FRAMES.....	108
FLEXI H FRAME KITS.....	109
FLEXI FOOT WITH STRUT.....	110
FLEXI FOOT UNIVERSAL.....	111
FLEXI FOOT VARIATIONS.....	112
FLEXI TWIN FRAMES.....	113
FLEXI QUAD FRAMES.....	114
FLEXI MODULAR FRAMES.....	115
FLEXI CUSTOM FRAMES.....	116
ACCESS (STEP & HOP OVERS).....	117

FIXINGS

119

SLOTTED CHANNEL.....	120
CHANNEL ACCESSORIES.....	122
CABLE TRAYS.....	123
BASKET TRAYS.....	124
WASHERS.....	125
NUTS.....	126

SCREWS.....	127
BOLTS.....	129
CLAMPS & CLIPS.....	129
SWITCHES/ISOLATORS/GLANDS.....	132
CABLES & ACCESSORIES.....	133

OIL & LUBRICANT

135

VACUUM PUMP OIL.....	136, 176
FUCHS OILS.....	136

TOOLS

143

RECOVERY MACHINES.....	145
LEAK DETECTION.....	156
SCALES.....	163
VACUUM PUMPS.....	171
HAND TOOLS.....	179
• EXPANDER.....	180
• FLARING & SWAGING.....	181, 189
• TUBING TOOLS.....	182
• TESTING & SERVICE.....	194
• COUPLER & ADAPTORS.....	197
• COMBINATION TOOLS.....	196
• LINE SET BENDER.....	202
MANIFOLDS.....	203
GAUGES & HOSES.....	209
HILMOR RANGE.....	215
• HOSES.....	216
• TUBE BENDER.....	217
• FLARING & SWAGING.....	222
• TUBE CUTTERS.....	226
• SCREWDRIVERS.....	230
• MULTI-TOOLS.....	234
• HEX KEYS.....	236
• WRENCHES.....	237
• PLIERS.....	239
• STRIPPERS.....	242
• DEBURRING.....	242
• UTILITY KNIFE.....	243



NEED TO TAKE EXTERNAL IMAGES

PRODUCTS

We strive to deliver to you, our customers, the best products on the market - constantly innovating and improving. Our products are designed to save you time. We are the only company which covers the ancillary range for the HVAC&R market.

OUR ETHOS

We aim to be the solution provider for the industry. We aim listen to our customers, and provide the fastest response time within the industry.

EXPERIENCED STAFF

We understand that each customer's needs are unique. Our team at DiversiTech International respect and consider this in every decision we make. Face-to-face, over the phone or electronically - we are here to serve you. Our sales and technical teams strive for the highest standards.

TECHNICAL EXPERTS

We believe that delivering exceptional technical support is crucial to the success of our customers. All our staff are technically trained, and we have a team of people ready to help you.

INTERNATIONAL

Globally connected operations within 30 countries, and across 5 continents. We are continually customising our products and services to suit the individual needs of our international customer base.

CHARITABLE GIVING

We continue to support local charities such as Maytree Respite Centre, the Brain Tumour Charity, and local sports teams and organisations. We recognise these institutions, and all their voluntary work, as being inspiring and unconditional.

REFRIGERATION



PUMPS



DAIRY CABINET SUPERMARKET PUMPS

These dairy cabinet supermarket pumps can fit under low display cabinets due to being just 76mm in height. The multiple inlets offer a variety of installation options for the contractor.



Part code	Description	Tank capacity	Lift	Max flow	Dimensions mm (HxWxD)	Discharge size (inches)
DCP-30A	Dairy cabinet pump (standard with safety switch)	5.5L		700LPH	76 x 200 x 610	1/2
DCP-30E	Dairy cabinet pump (no S/S or L/D)	5.5L		700LPH	76 x 200 x 610	1/2
DCP-30V	Dairy cabinet pump (vertical)	4.5L		700LPH	200 x 580 x 76	1/2
DCP-P	High-pressure replacement pump	-		700LPH	-	3/8

NEED THESE PLEASE

EVAPORATOR TRAY

A thermostatically- controlled cast aluminium tray designed to collect and evaporate condensate water. Ideal for refrigeration display cabinets.



Part code	Description	Tank capacity	Evaporation rate	Dimensions mm (HxWxD)	Weight
ET-150	Evaporator tray	1.5L	150ml per hour	90 x 320 x 120	1.1kg

VIBRATION ABSORBER

Designed for the installation of the suction and discharge lines of air conditioning and refrigeration systems. Used to dampen compressor-induced vibrations and reduce the damage to the system's pipe work.



Part code	Description	Tube OD (inches)	Tube OD (mm)	Max working pressure (PsiG)	Burst pressure (PsiG)
VIBA-1/4	Vibration Absorber 1/4 (6mm)	1/4	6mm	650 (44.8 bar)	3250 (224 bar)
VIBA-3/8	Vibration Absorber 3/8 (10mm)	3/8	10mm	650 (44.8 bar)	3250 (224 bar)
VIBA-1/2	Vibration Absorber 1/2 (12mm)	1/2	12mm	650 (44.8 bar)	3250 (224 bar)
VIBA-5/8	Vibration Absorber 5/8 (16mm)	5/8	16mm	650 (44.8 bar)	3250 (224 bar)
VIBA-3/4	Vibration Absorber 3/4 (18mm)	3/4	18mm	650 (44.8 bar)	3250 (224 bar)
VIBA-7/8	Vibration Absorber 7/8 (22mm)	7/8	22mm	650 (44.8 bar)	3250 (224 bar)
VIBA-1-1/8	Vibration Absorber 1-1/8 (28mm)	1-1/8	28mm	600 (41.3 bar)	3000 (206.8 bar)
VIBA-1-3/8	Vibration Absorber 1-3/8 (35mm)	1-3/8	35mm	550 (37.9 bar)	2750 (189.6 bar)
VIBA-1-5/8	Vibration Absorber 1-5/8 (42mm)	1-5/8	42mm	510 (35.1 bar)	2550 (175.8 bar)
VIBA-2-1/8	Vibration Absorber 2-1/8 (54mm)	2-1/8	54mm	400 (27.5 bar)	2000 (137.8 bar)
VIBA-2-5/8	Vibration Absorber 2-5/8 (64mm)	2-5/8	64mm	350 (24.1 bar)	1750 (120.6 bar)
VIBA-3-1/8	Vibration Absorber 3-1/8 (76mm)	3-1/8	76mm	320 (22.0 bar)	1600 (110.3 bar)
VIBA-3-5/8	Vibration Absorber 3-5/8 (89mm)	3-5/8	89mm	190 (13.1 bar)	570 (39.3 bar)
VIBA-4-1/8	Vibration Absorber 4-1/8 (108mm)	4-1/8	108mm	190 (13.1 bar)	570 (39.3 bar)

K-KLAMP - PIPE AND INSULATION CLAMP

K-KLAMP eliminates having to double-wrap, glue and tape the insulation on strut-mounted clamps. K-KLAMP pipe and insulation coupling reduces the time required to insulate copper tubing used for refrigerant lines. Our clamp allows sections of closed-cell insulation to be secured at fixing points.



Part code per size	Insulation wall thickness			
	3/8"	1/2"	3/4"	1"
1/4"	K38-14	-	K34-14	-
3/8"	K38-38	K12-38	K34-38	-
1/2"	K38-12	K12-12	K34-12	K100-12
5/8"	K38-58	K12-58	K34-58	K100-58
3/4"	K38-34	K12-34	K34-34	K100-34
7/8"	K38-78	K12-78	K34-78	K100-78
1"	K38-100	K12-100	-	-
1-1/8"	K38-118	K12-118	K34-118	K100-118
1-3/8"	K38-138	K12-138	K34-138	K100-138
1-5/8"	K38-158	K12-158	K34-158	K100-158
2-1/8"	K38-218	K12-218	K34-218	K100-218
2-5/8"	-	K12-258	K34-258	K100-258
3-1/8"	-	K12-318	K34-318	K100-318
3-5/8"	-	K12-358	K34-358	K100-358
4-1/8"	-	K12-418	K34-418	K100-418

Klo-Shure Part code	Discharge size (inches)
729037	Klo-Shure 3/8" ID x 1-1/2"
729050	Klo-Shure 1/2" ID x 1-1/2"
729062	Klo-Shure 5/8" ID x 1-1/2"
729087	Klo-Shure 7/8" ID x 1-1/2"
729112	Klo-Shure 1-1/8" ID x 1-1/2"
729137	Klo-Shure 1-3/8" ID x 1-1/2"
729162	Klo-Shure 1-5/8" ID x 1-1/2"
729212	Klo-Shure 2-1/8" ID x 1-1/2"
729262	Klo-Shure 2-5/8" ID x 1-1/2"
729312	Klo-Shure 3-1/8" ID x 1-1/2"
729412	Klo-Shure 4-1/8" ID x 1-1/2"

UNIVERSAL MULTI-FIT FAN MOTORS

Universal multi-fit fan motors are individually boxed and come complete with fixings. The 1m power cord offers flexibility during installation. CE certified / ROHS-2 compliant.



Part code	Description	Watts	Voltage	Frequency	Revs	Cable length
FM-5W	Universal multi-fit fan motor - 5W	5W	240V	50-60Hz	1300/1500 rpm	1m
FM-7W	Universal multi-fit fan motor - 7W	7W	240V	50-60Hz	1300/1500 rpm	1m
FM-10W	Universal multi-fit fan motor - 10W	10W	240V	50-60Hz	1300/1500 rpm	1m
FM-16W	Universal multi-fit fan motor - 16W	16W	240V	50-60Hz	1300/1500 rpm	1m
FM-18W	Universal multi-fit fan motor - 18W	18W	240V	50-60Hz	1300/1500 rpm	1m
FM-25W	Universal multi-fit fan motor - 25W	25W	240V	50-60Hz	1300/1500 rpm	1m
FM-34W	Universal multi-fit fan motor - 5W	34W	240V	50-60Hz	1300/1500 rpm	1m

TANGENTIAL FAN MOTORS

Tangential single-impeller fan motor assemblies with aluminium blades. Individually boxed complete with fixings. CE certified / ROHS-2 compliant.



Part code	Description	Watts	Blade length	Rotate speed	Air flow
FMTS-ISW-120	Tangential Fan Motor 15W with 120mm Blade	15W	120mm	2200rpm	80m ³ /h
FMTS-20W-120	Tangential Fan Motor 20W with 180mm Blade	20W	180mm	2000rpm	120m ³ /h
FMTS-30W-240	Tangential Fan Motor 30W with 240mm Blade	30W	240mm	2100rpm	170m ³ /h
FMTS-30W-300	Tangential Fan Motor 30W with 300mm Blade	30W	300mm	1900rpm	190m ³ /h

AXIAL FAN MOTORS

Axial shaded fan motors have a compact structure and small volume. Lightweight, low noise and used on refrigeration equipment. Individually boxed, CE certified/ ROHS-2 compliant, these motors have an ambient operating temperature -20° C to +60° C



Part code	Description	Watts	Voltage	Frequency	Revs	Cable length	Air flow
FM-A-8038-L	Axial Fan Motor - 15W (with lead)	15W	240V	50Hz	2200rpm	30mm	40m ³ /h
FM-A-12025-L	Axial Fan Motor - 13W (with lead)	15W	240V	50Hz	1800rpm	30mm	71m ³ /h
FM-A-12038-L	Axial Fan Motor - 20W (with lead)	20W	240V	50Hz	2500rpm	30mm	132m ³ /h
FM-A-12038-T	Axial Fan Motor - 20W (with terminal)	20W	240V	50Hz	2500rpm	-	132m ³ /h

Part code	Description	Watts	Db(A) rating	Height	Width	Depth
FM-A-8038-L	Axial Fan Motor - 15W (with lead)	15W	23.4	80mm	80mm	38mm
FM-A-12025-L	Axial Fan Motor - 13W (with lead)	15W	35.6	120mm	120mm	26mm
FM-A-12038-L	Axial Fan Motor - 20W (with lead)	20W	37.3	120mm	120mm	38mm
FM-A-12038-T	Axial Fan Motor - 20W (with terminal)	20W	37.3	120mm	120mm	38mm

FAN MOTOR ASSEMBLIES

A complete range of pressed aluminium blades, fan rings, guards and brackets to suit our range of multi-fit fan motors. Available in a variety of diameters and pitches to suit most refrigeration applications. All accessories can be sold as individual items or as a complete assembly combined to create your own fan requirements.



Part code	Description	Diameter	Pitch
FBS-154-25	Fan Blade - sucker	154mm	25°
FBS-154-31	Fan Blade - sucker	154mm	31°
FBS-172-25	Fan Blade - sucker	172mm	25°
FBS-172-31	Fan Blade - sucker	172mm	31°
FBS-200-25	Fan Blade - sucker	200mm	25°
FBS-200-31	Fan Blade - sucker	200mm	31°
FBS-230-25	Fan Blade - sucker	230mm	25°
FBS-230-31	Fan Blade - sucker	230mm	31°
FBS-254-25	Fan Blade - sucker	254mm	25°
FBS-254-31	Fan Blade - sucker	254mm	31°
FBS-300-25	Fan Blade - sucker	300mm	25°
FBS-300-31	Fan Blade - sucker	300mm	31°

Part code	Description	Diameter	Pitch
FBB-154-25	Fan Blade - blower	154mm	25°
FBB-154-31	Fan Blade - blower	154mm	31°
FBB-172-25	Fan Blade - blower	172mm	25°
FBB-172-31	Fan Blade - blower	172mm	31°
FBB-200-25	Fan Blade - blower	200mm	25°
FBB-200-31	Fan Blade - blower	200mm	31°
FBB-230-25	Fan Blade - blower	230mm	25°
FBB-230-31	Fan Blade - blower	230mm	31°
FBB-254-25	Fan Blade - blower	254mm	25°
FBB-254-31	Fan Blade - blower	254mm	31°
FBB-300-25	Fan Blade - blower	300mm	25°
FBB-300-31	Fan Blade - blower	300mm	31°

Part code	Description	Diameter
FRS-154	Fan ring	154mm
FRS-172	Fan ring	154mm
FRS-200	Fan ring	172mm
FRS-230	Fan ring	172mm
FRS-254	Fan ring	200mm
FRS-300	Fan ring	200mm

Part code	Description	Diameter
FG-154	Fan guard	154mm
FG-172	Fan guard	154mm
FG-200	Fan guard	172mm
FG-230	Fan guard	172mm
FG-254	Fan guard	200mm
FG-300	Fan guard	200mm

Part code	Height	Width	Depth
FBR-109-1	109mm	81mm	24mm
FBR-109-2	109mm	78mm	49mm
FBR-109-3	109mm	78mm	49mm
FBR-39	39mm	-	-
FBR-55	55mm	-	-
FBR-72	72mm	-	-
FBR-84	84mm	-	-

FAN MOTOR



FAN BLADE



FAN BRACKET



FAN RING



FAN GUARD



*** DON'T QUESTION WHERE COMPLETE FAN MOTOR ASSEMBLIES ARE (FMRMS)**

ISOLATORS



ROTARY ENCLOSED ISOLATORS

Our insulated 3 and 4 pole rotary enclosed isolators are CE marked and suitable for disconnecting the power supply to outdoor air conditioning units.

The isolators are weatherproof to IP65, easy to install and conform to IEC 60947-3. They have a lockable off position and interlocking cover which can be removed only in the off position. Earth and neutral terminals included and M20/25 knockouts up to 63A.



Part code	No of poles	AMPS AC21	AC23 A 240VA	AC23 A 400VA	Cable capacity		Height	Width	Depth
					Solid	Stranded			
IS-3P-20A-S	3	20amp	5.5kW	3.7kW	1-16mm ²	0.75-10mm ²	125mm	100mm	120mm
IS-3P-32A-S	3	32 amp	11kW	7.5kW	1-16mm ²	0.75-10mm ²	125mm	100mm	120mm
IS-3P-20A	3	20amp	5.5kW	3.7kW	1-16mm ²	0.75-10mm ²	175mm	114mm	135mm
IS-3P-32A	3	30amp	11kW	7.5kW	1-16mm ²	0.75-10mm ²	175mm	114mm	135mm
IS-3P-40A	3	40amp	15kW	11kW	1-16mm ²	0.75-10mm ²	175mm	114mm	135mm
IS-3P-63A	3	63amp	22kW	18.5kW	1-16mm ²	0.75-10mm ²	175mm	114mm	135mm
IS-4P-20A-S	4	20amp	5.5kW	3.7kW	1-16mm ²	0.75-10mm ²	125mm	100mm	120mm
IS-4P-32A-S	4	32 amp	11kW	7.5kW	1-16mm ²	0.75-10mm ²	125mm	100mm	120mm
IS-4P-20A	4	20amp	5.5kW	3.7kW	1-16mm ²	0.75-10mm ²	175mm	114mm	135mm
IS-4P-32A	4	32amp	11kW	7.5kW	1-16mm ²	0.75-10mm ²	175mm	114mm	135mm
IS-4P-40A	4	40amp	15kW	11kW	1-16mm ²	0.75-10mm ²	175mm	114mm	135mm
IS-4P-63A	4	63amp	22kW	18.5kW	1-16mm ²	0.75-10mm ²	175mm	114mm	135mm

PROTECTIVE HOUSING



Easy-Fit housings are manufactured in two sizes and are ideal for all brands of outdoor refrigeration condensing equipment.

The steel goes through an 8-phase epoxy polyester powder coating process and is finished with a scratch resistant textured finish in RAL 7032.



Part code	Size	External dimensions mm			Internal dimensions mm			Weight
		H	W	D	H	W	D	
CH-S	Small	500	710	600	410	640	530	23kg
CH-L	Large	550	810	720	460	740	640	30kg

REFRIGERANT ID LABELS

A range of self adhesive vinyl labels. Each label indicates the type of refrigerant and come in a handy pack of 10. We also supply pipe labels. Avoid costly mistakes by properly identifying the type of refrigerant contained in recovery cylinders and air conditioning and refrigeration equipment. Contact us for more information.





Part code	Description	Size
601231292	Fuchs Reniso Triton SEZ 22	5 L
600669812	Fuchs Renison Triton SEZ 32	1L
601231339	Fuchs Reniso Triton SEZ 32	5L
600646509	Fuchs Reniso Triton SE55	1L
601231414	Fuchs Reniso Triton SE 55	5 L
600680107	Fuchs Reniso Triton SEZ 68	1L
601231254	Fuchs Renison Triton SEZ 68	5L
601231278	Fuchs Reniso Triton SE 170	5L
600680442	Fuchs Reniso Triton SE 170	10L
600756512	Fuchs Reniso PAG 100	1L
600741105	Fuchs Reniso C85 E	1L
600360382	Fuchs Reniso C85 E	10L

WHY USE FUCHS

<p>1 High thermo-chemical stability e.g. in Sealed Glass Tube Test (ASHRAE 97-2007)</p> <p>Standard POE refrigeration oils RENO TRITON SEZ 80</p>	<p>2 Very good miscibility with HFC/FC: e.g. in miscibility evaluation (DIN 51514)</p> <p>Standard POE refrigeration oils RENO TRITON SEZ 80</p>	<p>3 Low varnish / low sludge formation e.g. in FUCHS In-house test (evaluation of oil sludge in beaker with bearing roller after 168h/135 °C)</p> <p>Standard POE refrigeration oils RENO TRITON SEZ 80</p>	<p>4 Reliable wear protection e.g. in bearing wear testing (DIN 51819-3)</p> <p>Standard POE refrigeration oils RENO TRITON SEZ 80</p>
---	--	--	--

RENISO TRITON SE/SEZ

Synthetic refrigeration oils based on polyol ethers (POE) for HFC/FC refrigerants

The refrigeration oils of the RENISO TRITON SE/SEZ series are based on synthetic esters that were especially developed for use with chlorine-free, fluorinated hydrocarbons (HFC/FC). In contrast to conventional refrigeration oils, these are miscible and compatible with polar HFC/FC.

Application

The RENISO TRITON SE/SEZ series is outstandingly suited for all refrigeration circuits, in which chlorine-free HFC/FC refrigerants, e.g. R134a, R404A or R410A are used. Depending on the viscosity, RENISO TRITON SE/SEZ refrigeration oils are recommended for hermetical, semihermetical and open piston compressors and for screw-type and turbo-compressors. RENISO TRITON SEZ 22 is especially suitable for deepfreeze systems operating with R23.

RENISO TRITON SE/SEZ products are also suitable for hydrocarbon refrigerants (e.g. propane, polypropylene, isobutane) and R22. In such cases please contact FUCHS prior to the usage.



Features

- Special synthetic polyolester
- Stable lubrication film even at high temperatures, outstanding lubricity
- Excellent solubility with HFC and FC refrigerants
- Very high thermal and chemical stability in the presence of fluorinated refrigerants
- Good viscosity-temperature behavior
- Excellent cold temperature flowability
- Secure oil return from the system, good heat transfer
- Good compatibility with elastomers and materials normally used in refrigeration circuits
- Readily biodegradable (ISO VG 32 and ISO VG 55)
- Approved by leading compressor manufacturers
- Ultra-dried

Product name	Unit	RENISO TRITON				Test method
		SEZ 22	SEZ 32	SE 55	SEZ 68	
Density at 15 °C	kg/m ³	1003	1004	1009	970	DIN 51757
Flash point	°C	248	250	286	258	DIN ISO 2592
Color	-	0	0.5	1.0	0.5	DIN ISO 2049
Kinematic viscosity at 40 °C	mm ² /s	20	32	55	68	DIN EN ISO 3104
at 100 °C	mm ² /s	4.4	6.1	8.8	8.9	
Viscosity index	-	133	141	137	104	DIN ISO 2909
Pourpoint	°C	-57	-57	-48	-39	DIN ISO 3016
Neutralization number	mgKOH/g	0.03	0.03	0.03	0.03	DIN 51558-1
Water content	mg/kg	< 50	< 50	< 50	< 50	DIN 51777-2

RENISO PAG 46 AND RENISO PAG 100

Fully synthetic refrigeration oils based on special polyglycols (PAG) for R134a A/C systems

Because of their Cl content, CFC refrigerants like R12 destroy the earth's ozone layer. This led all manufacturers to cease production of fully halogenized CFC's and introduce alternative products. This move is a reaction to the ban on CFC's and halons which established a timetable for the progressive ending of CFC production and use. Alternative refrigerants such as R134a have found general acceptance and are currently in use. As classic refrigeration oils based on mineral oils, polyalphaolefins and alkylbenzene oils are not miscible with R134a, new refrigeration oils had to be developed, RENISO PAG-Series.

Application

Most car and truck air conditioning systems use Japanese- or American-made compressors and R134a refrigerants. These compressors require the use of synthetic, polyglycol-based refrigeration oils such as RENISO PAG 46 or RENISO PAG 100. The RENISO PAG products have an excellent miscibility and compatibility with R134a.

RENISO PAG 46 and RENISO PAG 100 are based on polar polyglycols. The structure of polyglycols make them hygroscopic (= absorb moisture). This means that special care must be taken when handling such products (always keep containers tightly sealed, use nitrogen to cover the refrigeration oil and store drums in dry, air conditioned rooms).



Features

- Very high thermal stability
- Excellent miscibility and compatibility with R134a refrigerants (substitute for R12 refrigerants)
- Excellent viscosity-temperature behaviour (high VI)
- Low viscosity at low temperature, good flowability
- Stable lubricating film at high temperatures
- Good compatibility with all materials commonly used in refrigeration systems
- RENISO PAG 46 and RENISO PAG 100 are ultra-dried

Product name		PAG 46	PAG 100	
Refrigeration oil type acc. to DIN 51503-1		KD	KD	
Characteristics	Unit			Test method
Colour		colourless	colourless	Visual
Kinematic viscosity at 40 °C	mm ² /s	55	120	DIN EN ISO 3104
at 100 °C	mm ² /s	10.6	21	
Viscosity index		187	202	DIN ISO 2909
Density at 15 °C	kg/m ³	992	996	DIN 51757
Flashpoint, Cleveland open cup	°C	240	240	DIN ISO 2592
Pourpoint	°C	- 45	- 45	DIN ISO 3016
Neutralisation number	mgKOH/g	0.04	0.04	DIN 51558-1
Water content	ppm	300	300	DIN 51777-2
Stability with R134a, 175 °C / 14 days	--	pass	pass	ASHRAE 97-89

RENISO C 85 E

Synthetic refrigeration oil for CO₂ compressors

RENISO C 85 E is a special synthetic refrigeration oil based on synthetic esters. Selected additives guarantee excellent wear protection, also under the influence of CO₂ in the compressor. RENISO C 85 E has an excellent solubility / miscibility with the refrigerant carbon dioxide (R 744).

Application

RENISO C 85 E was developed for use mainly in refrigeration systems (deep-temperature systems, cascades, etc.) which are working with the refrigerant CO₂ (R 744). RENISO C 85 E has an excellent solubility / miscibility with CO₂ which guarantees the oil circulation in the refrigeration system, especially at low evaporation temperatures. RENISO C 85 E can be used in almost any application in industrial and commercial refrigeration, e.g. large-scale cooling plants. RENISO C 85 E can also be used in transcritical CO₂ cycles, e.g. air conditioning and heat pump systems, as well as container cooling systems.



Features

- High thermal stability
- High chemical stability with CO₂ refrigerant
- Excellent miscibility with CO₂ – also at low temperatures
- Excellent deep-temperature flowability
- Excellent lubrication at high pressure levels under CO₂ atmosphere
- Excellent experience in test facilities and prototype systems
- Used by leading compressor manufacturers.

Approvals:

DORIN

GEA BOCK

GEA GRASSO

JOHNSON CONTROLS INTERNATIONAL

Properties	Unit		Test Method
Colour		0.5	DIN ISO 2049
Density at 15 °C	kg/m ³	993	DIN 51757
Flashpoint	°C	246	DIN ISO 2592
Kinematic viscosity at 40 °C	mm ² /s	80	DIN EN ISO 3104
at 100 °C	mm ² /s	10.6	
Viscosity index	-	118	DIN ISO 2909
Pourpoint	°C	- 42	DIN ISO 3016
Neutralisation number	mgKOH/g	0.03	DIN 51558-1
Water content	mg/kg	< 30	DIN 51777-2

	FUCHS oil	Competitor equivalent	Refrigerants	Approvals
MINERAL OILS	<ul style="list-style-type: none"> • RENISO KM 32 • RENISO KS 46 • RENISO KC 68 • RENISO KES 100 	-	<ul style="list-style-type: none"> • For NH3 and R22 	-
	<ul style="list-style-type: none"> • RENISO WF 5 A • RENISO WF 7 A • RENISO WF 10 A • RENISO WF 15 A 	-	<ul style="list-style-type: none"> • For hydrocarbons (e.g. R600a - hermetic compressors) 	-
SYNTHETIC HYDROCARBON OIL	<ul style="list-style-type: none"> • RENISO ULTRACOOOL 68 • RENISO ULTRACOOOL 100 	<ul style="list-style-type: none"> • PETROCANADA REFLO 68 • KLUBER RHT 68 • CPI 1009 68 • MOBIL GARGOYLE ARCTIC SHC NH 68 226E • TEXACO CAPELLA P68 • TOTAL LUNARIA NH 68 	<ul style="list-style-type: none"> • NH3 (Ammonia) 	NSF H1 registered
POLYALPHAOLEPHINS (PAO) OILS	<ul style="list-style-type: none"> • RENISO SYNTH 68 	<ul style="list-style-type: none"> • PETROCANADA REFLO 68 • KLUBER RHT 68 • CPI 1009 68 • MOBIL GARGOYLE ARCTIC SHC NH 68 226E • TEXACO CAPELLA P68 • TOTAL LUNARIA NH 68 	<ul style="list-style-type: none"> • NH3 (Ammonia) 	NSF H1 registered
POLYALKALINEGLYCOL (PAG) OIL	<ul style="list-style-type: none"> • RENISO PG68 	-	<ul style="list-style-type: none"> • AMMONIA AND HYDROCARBONS 	-
	<ul style="list-style-type: none"> • RENISO LPG 68 	-	<ul style="list-style-type: none"> • HYDROCARBONS, e.g. R290, R1270, R600a 	-
ALKYLBENZENES (AB)	<ul style="list-style-type: none"> • RENISO SP 32 • RENISO SP 46 • RENISO SP 100 • RENISO SP 220 	-	<ul style="list-style-type: none"> • R22 AND HYDROCARBONS 	-
	<ul style="list-style-type: none"> • RENISO S 3246 • RENISO S 68 	-	<ul style="list-style-type: none"> • R22, HYDROCARBONS AND AMMONIA 	-

FUCHS SELECTION CHART



	FUCHS oil	Competitor equivalent	Refrigerants	Approvals
POLYOLESTER (POE) OILS	<ul style="list-style-type: none"> • RENISO SEZ 22 • RENISO SEZ 32 • RENISO SEZ 55 • RENISO SEZ 68 • RENISO SEZ 80 F • RENISO SE 100/170/220 	<ul style="list-style-type: none"> • BITZER BSE 32 • CASTROL ICEMATIC SW22-32-46-68-80 • SOLTEST 22-32-46-68-80 • EMKARTE RL22H-32-46-68-80 • MOBIL EAL ARCTIC 22-32-46-68-80 • SHELL CLAVUS R22-32-46-68-80 • SUNISO SL 22-32-46-68-80 • TEXACO CAPELLO HFC 22-32-46-68-80 • TOTAL PLANET ELF ACD 22-32-46-68-80 • BITZER BSE 150 170 • CASTROL ICEMATIC SW100-170-220 • CPI SOLTEST 100-170-220 • EMKARATE RL100 H-170-220 • MOBIL EAL ARCTIC 100-170-220 • SHELL CLAVUS R100-170-220 • SUNISO SL 100-170-220 • TOTAL PLANETELF ACD 100FY -150FY-220FY 	<ul style="list-style-type: none"> • Fully synthetic oil based on Polyol ester POE. Suitable for no ozone depleting FC/ HFC refrigerants. RENISO TRITON SE/SEZ suitable for HFO and HFO/HFC refrigerants. Suitable with new refrigerants designed to replace R22 such as R422A/D and R417a 	<ul style="list-style-type: none"> • BITZER • BOCK • COPELAND (SEZ 32) • DANFOSS • FRIGOPOL • GRASSO (SCREW SEZ 68) • MCQUAY EUROPA • PRESTCOLD • ROTOCOLD • SABROE • SUTRAK • TRANE USA • ZANUSSI
	• RENISO TRITON SEZ 320	-	R22	-
	• RENISO SEZ 35 SC	-	HFC/FC	-
SPECIAL POLYOLESTER (POE) OIL	<ul style="list-style-type: none"> • RENISO C55 E • RENISO C85 E • RENISO C170 E 	-	<ul style="list-style-type: none"> • SUBCRITICAL CO2 • SUBCRITICAL/ TRANSCRITICAL CO2 • SUBCRITICAL CO2 (screw compressor) 	<ul style="list-style-type: none"> • BITZER • DANFOSS • GEA BOCK • GRASSO • LINDE CARRIER • OBRIST • YORK
SPECIAL POLYALKALINE GLYCOL (PAG)	• RENISO ACC	-	• CO2 -AC CAR SYSTEMS	-
	• RENISO ACC 68 PAG	-	• CO2 -HEAT PUMPS/ CARS	-
SPECIAL POLYALKALINE GLYCOL (PAG) FOR MOBILE AC SYSTEMS	• RENISO PAG 46	-	• R134A, HYDROCARBONS, AMMONIA	-
	• RENISO PAG 100	-	• R1234YF, R134A MOBILE SYSTEMS	-
	• RENISO ACC HV	-	• CO2 MOBILE AC SYSTEMS	-
SPECIAL POE FOR MOBILE AC SYSTEMS - HYBRID AND ELECTRIC CARS	• RENISO TRITON SEZ 75 AC	-	• R1234YF, R134A, ELECTRIC COMPRESSORS	-

AIR CONDITIONING

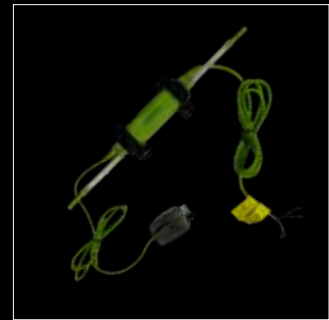
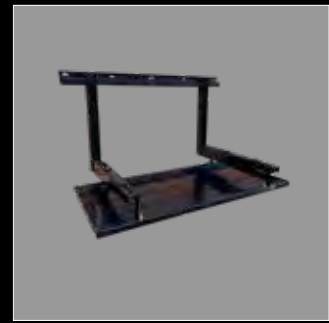

A close-up photograph of a Hilmer orbital flare fitting. The fitting is made of polished metal and features a central circular opening with a conical inner surface. The outer edge is flared and has a hexagonal shape. The background is dark, highlighting the metallic texture and the precision of the manufacturing.

Hilmer® RANGE

PAGE 215

Orbital Flare
1838952

CONDENSATE PUMPS AND ACCESSORIES



DiversiTech International stock a range of various branded condensate removal tank pumps.



PH-1L/PH-1SS



WHISPA-Q 1L



VCCA-20S



VCMX-20S



VCMA-20S



WHISPA-Q 2L



PH-2L/PH-2LSS



VCL-24S



VCL-45S

Part code	Description	Max head	Max flow	dB(A)	Dimensions mm (HxWxD)	Discharge size (inches)
PH-1L / PH-1L-SS	1 Litre Tank Pump	6m	270LPH	43	122x220x134	3/8
WHISPA-Q-1L	1 Litre Tank Pump	6m	14LPH	12	127x170x81	1/4
VCCA-20S	1 Litre Tank Pump	4.3m	294LPH	58-62	125x300x125	1/4 & 3/8
VCMX-20S	1.4 Litre Tank Pump	4.8m	284LPH	58	165x260x122	1/4 & 3/8
VCMA-20S	1.9 Litre Tank Pump	4.3m	294LPH	58-62	178x288x127	1/4 & 3/8
PH-2L / PH-2L-SS	2 Litre Tank Pump	4.8m	300LPH	60	180x290x130	1/4 & 3/8
WHISPA-Q -2L	2 Litre Tank Pump	6m	14LPH	12	165x250x135	1/4
VCL-24S	3.8 Litre Tank Pump	5.9m	900LPH	58-62	263x305x150	1/4 & 3/8
VCL-45S	3.8 Litre Tank Pump	10.5m	1560LPH	58-62	267x305x150	3/8
REDBOX-1L-S	1 Litre Tank Pump	5.1m	280LPH	44	120x150x300	3/8 & 1/4
REDBOX-2L-S	2 Litre Tank Pump	5.1m	280LPH	44	170x150x300	3/8 & 1/4

CONDENSATE PUMPS AND ACCESSORIES



REDBOX-1L-S 1 LITRE CONDENSATE PUMP

The DiversiTech RedBox 1 Litre Tank Pump is a condensate tank pump with a flow rate of 280 LPH and a lift of 5.1 metres. This pump has metal mounting tabs which allows the tank to be screwed to the wall. The universal power lead makes the pump easy to install, service and retrofit.

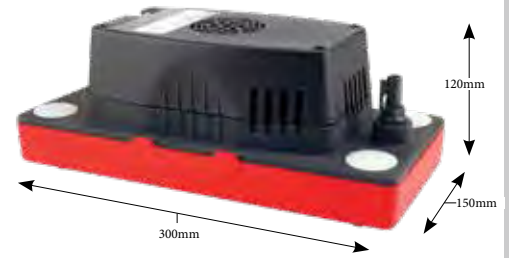

The unique LED indicators highlight when the pump has power, is running and when the high level alarm has been activated.



MAX. FLOW 280 LPH



TANK CAP. 1L



DECIBEL RATING 44 DB(A)

Part code	Max. lift	Discharge size	Watts	IP	Amps	Volts	HZ
REDBOX-1L-S	5.1m	3/8" / 1/4"	60W	20	1.0A	230V	50Hz

High level alarm	Inlet height fr. base	Weight	Cable length	Drink cycle	On level	Off level	Reserve before overflow	Alarm level
230V / 3A	112mm	2.3kg	1.8m	460ml	15.5mm	6mm	140ml	25mm

REDBOX-2L-S 2 LITRE CONDENSATE PUMP

The DiversiTech RedBox 2 Litre Tank Pump is a condensate tank pump with a flow rate of 280 LPH and a lift of 5.1 metres. This pump has metal mounting tabs which allows the tank to be screwed to the wall. The universal power lead makes the pump easy to install, service and retrofit.



The unique LED indicators highlight when the pump has power, is running and when the high level alarm has been activated.



MAX. FLOW 280 LPH



TANK CAP. 2L



DECIBEL RATING 44 DB(A)

Part code	Max. lift	Discharge size	Watts	IP	Amps	Volts	HZ
REDBOX-2L-S	5.1m	3/8" / 1/4"	60W	20	1.0A	230V	50Hz

High level alarm	Inlet height fr. base	Weight	Cable length	Drink cycle	On level	Off level	Reserve before overflow	Alarm level
230V / 3A	112mm	2.3kg	1.8m	1.45	47mm	6.5mm	375ml	52mm

MINI PUMPS

DiversiTech International stock a range of mini condensate pumps ideal for split air conditioning systems, small enough to be placed in the unit, or within trunking. We also provide mini pump options that come with an elbow and length of trunking.



EC-1 (PUMP ONLY)



WHISPA-Q MINI



WHISPA-Q MINI AND TRUNKING



EC-1 KIT with elbow and trunking



DE-05-FD Flowatch Design® with elbow and trunking

Part code	Description	Max head	Max flow	dB(A)	Dimensions mm (HxWxD)	Discharge size (inches)
EC-1	1 Litre Tank Pump	10m	10LPH	21	104x46x58	1/4"
EC-1 KIT	Mini pump with trunking	10m	10LPH	21	104x46x58	1/4"
DE-05-FD	Mini pump with trunking	10m	12LPH	< 21	800x150x80	1/4"
WHISPA-Q-MINI	Mini pump	6m	16LPH	21	-	-
WHISPA-Q-TRUNK	Mini pump with trunking	6m	16LPH	21	-	-
MF-2	Mini Flowatch 2	10m	12LPH	< 21	800x150x80	1/4"

CONDENSATE PUMPS AND ACCESSORIES



PRESSURE RELIEF & BOILER CONDENSATE PUMP

PRV*Sure*

This pump is manufactured from high temperature plastic, and comes complete with 10m of higher specification hose.

It meets EN standards and can handle temperatures up to 110 degrees. Supplied with 10m of 'no sag' high-grade braided hose. This unique design also cools PRV discharge so it is safe for use with solvent weld pipework. For installers who are audited or working to EN standards.



Part code	Description	Max head	Max flow	Temperature	Dimensions mm (HxWxD)	Discharge size
PH-3.8L-HW	Pressure relief and boiler condensate pump	8m	312 LPH	110°C	249x325x160	3/8 inch (9.5mm)

HIGH TEMPERATURE PRESSURE RELIEF PUMP

Designed for unvented cylinder T&P discharge and steam humidifiers. Having one of the largest discharge rates of 32 litres per minute this pump can handle both high temperatures (up to 100°C) and high flow rates.

Manufactured in the UK, this heavy-duty, high temperature tank pump incorporates thermal overload protection and a high level alarm switch.



Part code	Description	Max head*	Max flow	Temperature	Dimensions mm (HxWxD)	Discharge size
PH-5L-HW	High temperature & pressure relief pump	8m / 20m	1920LPH 32LPM	100° C	350x190x260	15mm

*Max heads - 8m for flow rates up to 25L per minute / 20m for flow rates of 5L per minute

ADAPTORS

WHAT IS ECOD IMAGE BLACK?

DiversiTech International stock a range of adaptors to connect the unit to the pump.



Part code	Description	Pump type application	Pack QTY
ADAP-CAC-S	Cassette adaptor - small (green) 3/4" x 1"	Tank pump / gravity	3 pack
ADAP-CAC-M	Cassette adaptor - medium (blue) 3/4" x 1-1/4"	Tank pump / gravity	3 pack
ADAP-CAC-L	Cassette adaptor - large (black) 3/4" x 1-1/2"	Tank pump / gravity	3 pack
ADAP-CAC-X	Cassette adaptor - multipack	Tank pump / gravity	3 pack
ADAP-1	Condensate drain adaptor - 22mm to 3/8" (95mm)	Tank pump - 9.5mm (3/8") outlet	Single
ecop-adap	Condensate drain adaptor - 16, 18, 22, 25mm to 3/8" hose	All pumps	Single
cv-38-3	Non-return check valve - 3/8" (9.5mm) VCMA/VCC	Tank pump - 9.5mm (3/8") outlet	3 pack
cv-14-3	Non-return check valve - 1/4" VCMA/VCC	Tank pump - (1/4") outlet	3 pack
ph-pump-nrv	Non-return check valve - 3/8" (9.5mm) PH	Tank pump - 9.5mm (3/8") outlet	Single
154724	Non-return check valve - 3/8" (9.5mm)	VCMX-20s pump	Single

SELF-SEALING PIPE ADAPTOR



The self-sealing adaptor is used to form a connection between the condensate hose and a soil and vent pipe. Drill a 13mm hole (for SVA-3) or a 10mm hole (for SVA-6), insert and twist to seal the connection.

Part code	Description	Pack QTY
SVA-3	Self-sealing pipe adaptor - 6mm & 9.5mm (1/4 & 3/8) hose to soil and vent pipe	3 pack
SV-ADAPTOR	Self-sealing pipe adaptor - 6mm & 9.5mm (1/4 & 3/8) hose to soil and vent pipe	Single
SVA-6-3	Self-sealing pipe adaptor - 6mm (1/4) hose to soil and vent pipe	3 pack
SV-ADAPTOR-6	Self-sealing pipe adaptor - 6mm (1/4) hose to soil and vent pipe	Single

AUDIBLE ALARM



This audible alarm can be wired into all pumps with a high-level alarm switch

Part code	Description	Pack QTY
AUDIBLE ALARM	Audible alarm for all pumps with a high-level alarm switch	3 pack

WHAT IS ECOD 5/8, 16, 18, 22 & 25?

CONDENSATE PUMPS AND ACCESSORIES



CONDENSATE BRAIDED HOSE

Our reinforced PVC braided hose is suitable for condensate drains and comes packaged in clear shrink wrap for protection and easy storage. The black hose has no light penetration, which prevents build-up of mould growth.



Available in clear and black, in 6m and 30m coils.

Part code	Colour	Description	ID	OD	Pressure in bar		Min bend radius	Min temp *	Max temp
					Working	Burst			
RVT-1/4	Clear	1/4" x 30 metres	6mm	10mm	7	21	30°	-15°C	+60°C
RVT-3/8	Clear	3/8" x 30 metres	10mm	14mm	8	24	30°	-15°C	+60°C
RVT-1/2	Clear	1/2" x 30 metres	12mm	16mm	6	18	30°	-15°C	+60°C
RVT-5/8	Clear	5/8" x 30 metres	16mm	20mm	6	18	30°	-15°C	+60°C
RVT-1/4-B	Black	1/4" x 30 metres	6mm	10mm	7	21	30°	-15°C	+60°C
RVT-3/8-B	Black	3/8" x 30 metres	10mm	14mm	8	24	30°	-15°C	+60°C
RVT-1/2-B	Black	1/2" x 30 metres	12mm	16mm	6	18	30°	-15°C	+60°C
RVT-1/2-6	Clear	1/2" x 6 metres	12mm	16mm	6	18	30°	-15°C	+60°C
RVT-3/4-6	Clear	3/4" x 6 metres	19mm	23mm	6	18	30°	-15°C	+60°C

CLEAR VINYL HOSE



Applications include air conditioning and refrigeration condensate drains, condensate pumps discharge lines and humidifier overflows. Available in 30m coils.

Part code	Colour	Description	ID	OD	Quantity
VT-14	Clear	1/4" x 30 metres	6mm	10mm	30m
VT-38	Clear	3/8" x 30 metres	10mm	14mm	30m

Part code	Colour	Description	ID	OD	Quantity
7-14	Clear	1/4" x 30 metres	6.3mm	9.1mm	30m
7-38	Clear	3/8" x 30 metres	9.5mm	12.5mm	30m
7-12	Clear	1/2" x 30 metres	12.7mm	16mm	30m
7-58	Clear	5/8" x 30 metres	15.8mm	19.6mm	30m
7-34	Clear	3/4" x 30 metres	19mm	23.1mm	30m
7-10	Clear	1" x 15 metres	25.4mm	30.8mm	30m

HOSE CONNECTORS AND CLAMPS

A range of nylon hose connectors and clamps for the connection of hoses. Secure fittings that prevent leaks.



Part code	Description	Pack qty
701-030	Hose connector - nylon 1/4	Single
701-032	Hose connector - nylon 3/8	Single
701-038	Hose T connector - nylon 3/8	Single

Part code	Description	Pack qty
B-4H	Hose clamp 3/16-5/16	Single
B-6H	Hose clamp 1/4-3/8	Single

CONDENSATE COP™



Condensate Cop™ is a unique clamp-on float switch intended for HVAC drain pan installation. The Condensate Cop features a large over-clamping area that fits easily over the edge of all types of drain pans; including formed plastic and galvanized sheet metal. A separate float/probe assembly swivels to accommodate drain pans having sloped sides. The swivel action allows the installer to position the float switch for best operation and then clamp it into place. The probe features an inlet grill which prevents the float from being blocked or damaged by insulation or other debris. Sealed inside the probe is a magnetically actuated normally closed switch. The switch opens when rising water presents a potential flooding condition.

Part code	Description	UOM	Master quantity
CC-1	Condensate Cop™ drain pan switch	Each	12

CSL 200 AC SHUTOFF SWITCH



The CS7 200 is an easy to install, reliable, condensate overflow detection switch. Featuring a unique universal pan mount design to assure accurate detection in metal or plastic secondary drain pans.

Part code	Description	UOM	Master quantity
CSL200	AC shut off switch	Each	12

DRAIN DAWG™



The Drain Dawg™ is a complete condensate drain cleaning kit, including the CT-475M deluxe nitrogen / CO₂ 0-475 psi regulator, the TG-10 & BS-25 ten foot hose and blowgun assembly, and the CW-15 fifteen inch whip hose. Also included is the AP-DD Drain Dawg™ Accessory Fitting Kit which contains the DF-75 Drain Dawg™ inflatable tip, the CK-141 3/4"-7" cone fitting, the FA-02 CO₂ to nitrogen adaptor, the QN-S3 needle tip, and the TC-25 tyre chuck.

Part code	Description	UOM	Master quantity
CB-2	Drain Dawg™ kit	Each	3

DRAIN KAT™



The Drain Kat™ is an over the shoulder, refillable, nitrogen or CO, mini drain cleaning kit. Featuring a small cylinder that holds 9 cubic feet of nitrogen or 2-7 / 2 pounds of CO₂. The cylinder includes an integral mounted regulator for a quick and easy adjustment of discharge pressure.

Part code	Description	UOM	Master quantity
MBK-6	Drain Kat™	Each	2

CONDENSING UNIT GUARDS



CONDENSING GUARDS

DiversiTech manufacture a range of weather-resistant, steel mesh guards, offering a safe solution to vandalism and accidental damage of your expensive AC unit or ASHP. The range is ideal for all manufacturers of air conditioning and air source heat pump units. The unique sliding panel system allows for easy installation, which are secured into place when the front panel is fitted. Back panels are also available to make the guard free standing. For high wall-mounted units, we can offer a base panel for full security.



Part code	Size	External dimensions mm (HxWxD)			Internal dimensions mm (HxWxD)			Weight
CG-S	S	750	1050	460	720	1020	450	18kg
CG-M	M	1150	1150	650	1120	1120	640	27kg
CG-L	L	1450	1150	650	1420	1120	640	30kg
CG-XL	XL	1800	1150	650	1770	1120	640	40kg
CG-500-S	S	620	1050	500	590	990	470	13kg
CG-500-M	M	1020	1050	500	990	990	470	18kg
CG-500-L	L	1420	1050	500	1390	990	470	23kg
CG-750-S	S	950	1150	750	920	1120	740	25kg
CG-750-S-INV	S	950	1450	750	920	1420	740	25.1kg
CG-750-M	M	1150	1150	750	1120	1120	740	32kg
CG-750-L	L	1450	1150	750	1420	1120	740	33kg
CG-750-INV	INV	1150	1450	750	1120	1420	740	33kg
CG-900L-INV	L-INV	1150	1450	900	1120	1420	890	34kg
CG-900L-SQ	L-SQ	1450	1450	900	1420	1370	890	51kg
CG-900-XXL	XXL	1800	1450	900	1770	1370	890	60kg
* CG-VRF-BP	BP-S	2000	1160	1200	1970	1130	1200	64kg
* CG-VRF-EP-6	EP-S	2000	580	1200	1970		1200	24kg
* CG-VRF-EP-12	EP-M	2000	1160	1200	1970		1200	41kg

* These products have a carriage surcharge

WOODEN GUARDS

Made from tanalised, pressure-treated timber. All panels have rounded louvers to optimise air flow. Sized to protect both ASHP and AC units, these guards offer a solution for listed buildings and sites where aesthetics are a consideration. All components are flat-packed for easy transport, and easy-to-install and assemble.



Part code	Size	External dimensions mm (HxWxD)			Internal dimensions mm (HxWxD)			Weight
CG-750S-WOOD	S	905/960	1275	865	850/890	1055	753	35kg
CG-750M-WOOD	M	1135/1135	1275	865	1075/1115	1055	753	40kg
CG-750M+WOOD	M+	255/1310	1275	865	1200/1240	1055	753	44kg
CG-750L-WOOD	L	1530/1585	1275	865	1475/1515	1055	753	51kg
CG-750L-INV-WOOD	L-INV	1130/1185	1630	865	1075/1115	1405	753	47kg
CG-750L+WOOD	L+	1600/1655	1275	865	1545/1585	1055	753	57kg
CG-750L+INV-WOOD	L+INV	1655/1690	1630	865	1580/1620	1405	753	59kg

WALL MOUNTING BRACKETS

Diversitech International offer a range of flat packed brackets, the Type 1 bracket has uprights and mounts directly onto the wall. Type 2 comes with a crossbar so that the uprights can be spaced exactly as required. The integral spirit level makes installation easier. Type 3 brackets have a unique interlocking mechanism enabling the arms to be joined in a matter of seconds.

For improved corrosion resistance all metal receives a 100% zinc plating, followed by a hard ED coating, before being finished with an external grade polyester textured powder coating in RAL 7032.

For lighter condensing units we offer an economy version. This incorporates the traditional crossbar style for easy spacing of the support arms. We also offer a range of stainless steel brackets, which are recommended for coastal locations exposed to sea salt or in corrosive environments.

WEATHER PROTECTION PROCESS ALL BRACKETS



PROCESS ONE
Corrosion resistant raw material, often referred to as Zintec



PROCESS TWO
Zinc phosphating process multi stage cleaning and dipping chemical zinc



PROCESS THREE
ED coating process: electrophoretic deposition (aka ED or EPD) coating



PROCESS FOUR
Epoxy polyester powder coating

NB: SEA SALTS ARE VERY CORROSIVE AND AFFECT BOTH FERROUS AND NON-FERROUS METALS. COASTAL INSTALLATIONS ARE PARTICULARLY AT RISK AS THEY ARE FREQUENTLY EXPOSED TO SEA SALT SOLUTIONS FOLLOWED BY DRY PERIODS, WHERE THIS WET/DRY CYCLE PRODUCES A VERY CORROSIVE ENVIRONMENT. WE STRONGLY RECOMMEND THAT IN SUCH LOCATIONS ONLY OUR STAINLESS STEEL BRACKETS ARE INSTALLED.

TYPE 1 BRACKETS

These flat-packed, self-assembly brackets provide a professional finish to the installation of wall-mounted outdoor condensing units and air source heat pumps. The Type 1 brackets have uprights that mount directly on to the wall via six shell anchor bolts provided, maximising the rigidity of the installation. For improved corrosion resistance all metal now receives a 100% zinc plating, followed by a hard ED coating, before being finished with an external grade polyester powder coating in RAL 7032.



Part code	Description	Safe working load*	Max load	Upright	Support arm	Weight
CBR1-S	Type 1 Bracket - Small	60kg	120kg	450mm	480mm	3.6kg
CBR1-M	Type 1 Bracket - Medium	90kg	180kg	500mm	530mm	4.6kg
CBR1-L	Type 1 Bracket - Large	140kg	280kg	550mm	580mm	4.7kg
CBR1-XL	Type 1 Bracket - Extra Large	250kg	500kg	550mm	660mm	8.8kg
CBR1-XXL	Type 1 Bracket - 2 x Extra Large	250kg	500kg	550mm	1000mm	11kg

CONDENSING BRACKETS



TYPE 2 BRACKETS

These flat-packed, self assembly brackets provide a professional finish to the installation of wall mounted outdoor condensing units and air source heat pumps. The Type 2 brackets have a crossbar allowing the uprights to be spaced exactly as required, and include wall spacers to help level the unit on uneven walls. All components receive a powder coating, with a scratch resistant, textured finish in a colour (RAL 7032) to match most brands of condensing units and domestic air source heat pumps.



Part code	Description	Safe working load*	Max load	Crossbar	Upright	Support arm	Weight
CBR2-S	Type 2 Bracket - Small	60kg	120kg	720mm	400mm	400mm	3.8kg
CBR2-M	Type 2 Bracket - Medium	90kg	180kg	900mm	500mm	500mm	4.6kg
CBR2-L	Type 2 Bracket - Large	140kg	280kg	1040mm	550mm	540mm	6.6kg
CBR2-XL	Type 2 Bracket - XL	250kg	500kg	1040mm	550mm	660mm	16.2kg
CBR2-XXL	Type 2 Bracket - Double XL	200kg	400kg	1040mm	550mm	780mm	17.3kg

Part code	Description (BLACK)	Safe working load*	Max load	Crossbar	Upright	Support arm	Weight
CBR2-XL-BL	Type 2 Bracket - XL	250kg	500kg	1040mm	550mm	660mm	16.2kg
CBR2-XL-3A-BL	Type 2 Bracket - XL (3 arms)	250kg	500kg	1040mm	550mm	660mm	21.5kg
CBR2-XXL-BL	Type 2 Bracket - Double XL	200kg	400kg	1040mm	550mm	780mm	17.3kg
CBR2-XXL-3A-BL	Type 2 Bracket - Double XL (3 arms)	200kg	400kg	1120mm	550mm	780mm	22.6kg

Part code	Description	Safe working load*	Max load	Crossbar	Upright	Support arm	Weight
CBR2-XL-3A	Type 2 Bracket - XL (3 arms)	250kg	500kg	1040mm	550mm	660mm	21.5kg
CBR2-XXL-3A	Type 2 Bracket - Double XL (3 arms)	200kg	400kg	1040mm	550mm	780mm	22.6kg

Part code	Description	Safe working load	Crossbar	Arm length	Weight
CBR2-EL	Economy bracket with crossbar	70kg*	800mm	550mm	3.73kg
CBE-140	Economy bracket with crossbar	140kg*	1000mm	550mm	5.5kg

* All brackets are tested to twice the safe working load at an independent UK facility.

TYPE 3 BRACKETS

The unique, interlocking mechanism of the Type 3 condensing unit brackets enable the arms to be joined to the uprights in a matter of seconds. A spring-lock automatically secures the joint, preventing the arms being dislodged accidentally. For improved corrosion resistance all metal now receives a 100% zinc plating, followed by a hard ED coating, before being finished with an external grade polyester powder coating in RAL 7032.



Part code	Description	Safe working load*	Max load	Upright	Support arm	Weight
CBR3-M	Type 3 Bracket - Medium	90kg	180kg	900mm	500mm	6.8kg
CBR3-L	Type 3 Bracket - Large	140kg	280kg	1040mm	540mm	8.3kg

*All brackets are tested to twice the safe working loads at an independent UK facility.

* It is the installer's responsibility to ensure that equipment weights do not exceed the safe working loads quoted and that the roof structure onto which these products are being applied is sufficiently sound to withstand the weight and point loading. If these products are used in contact with a PVC roof membrane, the installer should seek advice from the membrane manufacturer on the possible migration of plasticizers, and the effect of this on the roof guarantee. These products should not be used for any purpose other than that for which they have been designed, and the products must not be modified in any way. DiversiTech accepts no liability for damage caused by the incorrect application or installation of these products.

CONDENSING BRACKETS



STAINLESS STEEL WALL MOUNTING BRACKETS

Part code	Description	Specification
CBR2-M-SS	Condenser Mounting Bracket	Type 2 - 316SS 90kg
CBR2-L-SS	Condenser Mounting Bracket	Type 2 316SS - 140kg
CBR2-XL-SS	Condenser Mounting Bracket	Type 2 316SS-160kg

ANTI-VIBRATION MOUNTING BOLTS

The anti-vibration mounting bolts are in a convenient pack of 4. Each pack can be used with our wall brackets and is used as a method to absorb the vibrations generated by an ASHP or condensing unit.



Part code	Description	For use with	Pack QTY
AVMB-1	Anti-vibration Mounting Bolts	All brackets	4

CANTILEVER AMRS / CANTILEVER ARM KITS

These ready-made, hot-dipped galvanised steel cantilever arms with 14mm diameter holes, offer a quick and easy method of supporting condensing units on external walls. Available in straight or webbed versions, in a variety of lengths. This is a low cost option to mounting AC units or ASHP's.

The cantilever arm kits come with all of the fixings needed for a quick and easy installation.

Part code	Description	Safe working load*	Length	Weight
CA-150-S	Cantilever arm - Single 150mm	250kg	150mm	0.8kg
CA-300-S	Cantilever arm - Single 300mm	250kg	300mm	1kg
CA-450-S	Cantilever arm - Single 450mm	250kg	450mm	1.4kg
CA-600-S	Cantilever arm - Single 600mm	190kg	600mm	2kg
CA-750-S	Cantilever arm - Single 750mm	150kg	750mm	2.4kg
CA-900-S	Cantilever arm - Single 900mm	120kg	900mm	3kg



CA-600-W	Cantilever arm - Webbed 600mm	190kg	600mm	2.6kg
CA-750-W	Cantilever arm - Webbed 750mm	150kg	750mm	3kg
CA-950-W	Cantilever arm - Webbed 950mm	150kg	950mm	3kg
CA-1200-W	Cantilever arm - Webbed 1200mm	150kg	1200 mm	3kg



CA-600-D	Cantilever arm - Double 600mm	243kg	600mm	3.7kg
CA-750-D	Cantilever arm - Double 750mm	205kg	750mm	4.5kg
CA-900-D	Cantilever arm - Double 900mm	140kg	900mm	5.6kg
CA-1200-D	Cantilever arm - Double 1200mm	140kg	1200mm	5.6kg



Part code	Description	Height or equivalent	Width or equivalent	Length or equivalent	Weight	*Safe working load
CA-450-KIT	Cantilever arm kit - 450mm	750mm	41mm	450mm	8kg	250kg per arm
CA-600-KIT	Cantilever arm kit - 600mm	750mm	41mm	600mm	9kg	190kg per arm
CA-750-HKIT	Cantilever arm kit - 750mm	750mm	41mm	750mm	8kg	250kg per arm
CA-900-KIT	Cantilever arm kit - 900mm	900mm	41mm	900mm	8kg	250kg per arm

CONDENSING TRAYS



LIGHTWEIGHT CONDENSATE TRAYS

These 100% rust-free, UV stabilised, rigid, reinforced PVC condensate collection trays will fit any make of bracket. At less than 1kg, they are much easier to handle than metal trays and the tapered outlet fits a 16mm or 18mm hose pipe.



Part code	Description	Width	Length
CCT-790	Lightweight tray - small	390mm	790mm
CCT-940	Lightweight tray - large	420mm	940mm

METAL CONDENSATE TRAYS

These metal trays have a convex profile and a recessed surface flush, drain hose adaptor, minimising the amount of standing water left in the tray. Supplied with fixing arms for mounting to all Pump House brackets. For improved corrosion resistance all metal now receives a 100% zinc plating, followed by a hard ED coating, before being finished with an external grade polyester powder coating to RAL 7032.



Part code	Description	Width	Length	Depth	Weight
CCTM-800	Metal tray - small	400mm	800mm	25mm	5.23kg
CCTM-1080	Metal tray - 1080mm	500mm	1080mm	25mm	7.5kg
CCTM-1100	Metal tray - medium	400mm	1100mm	25mm	6.9kg
CCTM-1300	Metal tray - 1300mm	550mm	1300mm	25mm	8.8kg
CCTM-1400	Metal tray - large	400mm	1400mm	25mm	8.3kg

ZZZ

Part code	Description	Width	Length	Depth
CCTM-1420-BL	Metal tray	1420mm	500mm	25mm

FLOOR BRACKET KIT

When units are mounted at floor level, condensate discharge needs to be directed towards a drain or soakaway to avoid condensate causing a slip hazard. This floor bracket kit allows the metal tray to be mounted onto a flexi foot kit. The ASHP can then be mounted onto the bracket.



Part code	Description	For use with	Pack qty
CCTM-FLOOR-BRKT-KIT	Stainless steel brackets with fixings	Flexi Feet / trays	4
CCTM-FLOOR-BRKT-KIT-3	Stainless steel brackets with fixings (3 foot version)	Flexi Feet / trays	4
CCTM01420/BL			

NEED

INABA DENKO TRUNKING

The NEW range of Inaba Denko internal and external trunking will ensure that the air conditioning refrigeration pipes are protected with a professional finish. The three colours - black, ivory and white will match most brands of condensing units available, UV resistant, fire proof and can be painted to suit many indoor and outdoor applications.

STRAIGHT DUCT



Part code	Description
ID-NSD-100-I	Slimduct - 100mm - 2000mm - Ivory
ID-NSD-100-W	Slimduct - 100mm - 2000mm - White
ID-SD-100-K	Slimduct - 100mm - 2000mm - Black
ID-SD-100-B	Slimduct - 100mm x 2000mm - Brown
ID-NSD-75-I	Slimduct - 75mm - 2000mm - Ivory
ID-NSD-75-W	Slimduct - 75mm - 2000mm - White
ID-SD-75-K	Slimduct - 75mm - 2000mm - Black
ID-SD-75-B	Slimduct - 75mm - 2000mm - Brown

90° VERTICAL ELBOW



Part code	Description
ID-SC-100-I	Slimduct - 100mm Elbow Bend - Ivory
ID-SC-100-W	Slimduct - 100mm Elbow Bend - White
ID-SC-100-K	Slimduct - 100mm Elbow Bend - Black
ID-SC-75-I	Slimduct - 75mm Elbow Bend - Ivory
ID-SC-75-W	Slimduct - 75mm Elbow Bend - White
ID-SC-75-K	Slimduct - 75mm Elbow Bend - Black
ID-SC-75-B	Slimduct - 75mm Elbow Bend - Brown

45° VERTICAL ELBOW



Part code	Description
ID-SCF-100-I	Slimduct - 100mm 45 Degree Elbow Bend - Ivory
ID-SCF-100-W	Slimduct - 100mm 45 Degree Elbow Bend - White
ID-SCF-100-K	Slimduct - 100mm 45 Degree Elbow Bend - Black
ID-SCF-100-B	Slimduct - 100mm 45 Deg Elbow Bend - Brown
ID-SCF-75-I	Slimduct - 75mm 45 Degree Elbow Bend - Ivory
ID-SCF-75-W	Slimduct - 75mm 45 Degree Elbow Bend - White
ID-SCF-75-K	Slimduct - 75mm 45 Degree Elbow Bend - Black
ID-SCF-75-B	Slimduct - 75mm 45 Deg Elbow Bend - Brown

REDUCER



Part code	Description
ID-SDR-100-75-I	Slimduct - 100-75mm Reducer Joint - Ivory
ID-SDR-100-75-W	Slimduct - 100-75mm Reducer Joint - White
ID-SDR-100-75-K	Slimduct - 100-75mm Reducer Joint - Black

RAL COLOURS
 **BLACK: MUNSELL N-2.0**
 **WHITE: MUNSELL N9.0**
 **IVORY: MUNSELL 5Y8/1**
 **BROWN: MUNSELL 10YR3**

INABA DENKO TRUNKING

FLEXIBLE JOINT



Part code	Description
ID-SF-100-800-I	Slimduct - 100mm - 800mm Flexible Joint - Ivory
ID-SF-100-800-W	Slimduct - 100mm - 800mm Flexible Joint - White
ID-SF-100-800-K	Slimduct - 100mm - 800mm Flexible Joint - Black
ID-SF-100-800-B	Slimduct - 100mm - 800mm Flexible Joint - Brown
ID-SF-75-500-I	Slimduct - 75mm - 500mm Flexible Joint - Ivory
ID-SF-75-500-W	Slimduct - 75mm - 500mm Flexible Joint - White
ID-SF-75-500-K	Slimduct - 75mm - 500mm Flexible Joint - Black
ID-SF-75-500-B	Slimduct - 75mm - 500mm Flexible Joint - Brown

COUPLER



Part code	Description
ID-SJ-100-I	Slimduct - 100mm Connection Piece - Ivory
ID-SJ-100-W	Slimduct - 100mm Connection Piece - White
ID-SJ-100-K	Slimduct - 100mm Connection Piece - Black
ID-SJ-100-B	Slimduct - 100mm Connection Piece - Brown
ID-SJ-75-I	Slimduct - 75mm Connection Piece - Ivory
ID-SJ-75-W	Slimduct - 75mm Connection Piece - White
ID-SJ-75-K	Slimduct - 75mm Connection Piece - Black
ID-SJ-75-B	Slimduct - 75mm Connection Piece - Brown

90° FLAT ELBOW



Part code	Description
ID-SK-100-I	Slimduct - 100mm 90 Degree Flat Bend - Ivory
ID-SK-100-W	Slimduct - 100mm 90 Degree Flat Bend - White
ID-SK-100-K	Slimduct - 100mm 90 Degree Flat Bend - Black
ID-SK-100-B	Slimduct - 100mm 90 Deg Flat Bend - Brown
ID-SK-75-I	Slimduct - 75mm 90 Degree Flat Bend - Ivory
ID-SK-75-W	Slimduct - 75mm 90 Degree Flat Bend - White
ID-SK-75-K	Slimduct - 75mm 90 Degree Flat Bend - Black
ID-SK-75-B	Slimduct - 75mm 90 Deg Flat Bend - Brown

45° FLAT ELBOW



Part code	Description
ID-SKF-100-I	Slimduct - 100mm 45 Degree Flat Bend - Ivory
ID-SKF-100-W	Slimduct - 100mm 45 Degree Flat Bend - White
ID-SKF-100-K	Slimduct - 100mm 45 Degree Flat Bend - Black
ID-SKF-100-B	Slimduct - 100mm 45 Deg Flat Bend - Brown
ID-SKF-75-I	Slimduct - 75mm 45 Degree Flat Bend - Ivory
ID-SKF-75-W	Slimduct - 75mm 45 Degree Flat Bend - White
ID-SKF-75-K	Slimduct - 75mm 45 Degree Flat Bend - Black
ID-SKF-75-B	Slimduct - 75mm 45 Deg Flat Bend - Brown

RAL COLOURS
 **BLACK: MUNSELL N-2.0**
 **WHITE: MUNSELL N9.0**
 **IVORY: MUNSELL 5Y8/1**
 **BROWN: MUNSELL 10YR3**

INABA DENKO TRUNKING

JOINT



Part code	Description
ID-ST-100-I	Slimduct - 100mm T Joint - Ivory
ID-ST-100-W	Slimduct - 100mm T Joint - White
ID-ST-100-K	Slimduct - 100mm T Joint - Black
ID-ST-100-B	Slimduct - 100mm T-Joint - Brown
ID-ST-75-I	Slimduct - 75mm T Joint - Ivory
ID-ST-75-W	Slimduct - 75mm T Joint - White
ID-ST-75-K	Slimduct - 75mm T Joint - Black
ID-ST-75-B	Slimduct - 75mm T-Joint - Brown

WALL INLET



Part code	Description
ID-SW-100-I	Slimduct - 100mm Wall Cover - Ivory
ID-SW-100-W	Slimduct - 100mm Wall Cover - White
ID-SW-100-K	Slimduct - 100mm Wall Cover - Black
ID-SW-100-B	Slimduct - 100mm Wall Cover - Brown
ID-SW-75-I	Slimduct - 75mm Wall Cover - Ivory
ID-SW-75-W	Slimduct - 75mm Wall Cover - White
ID-SW-75-K	Slimduct - 75mm Wall Cover - Black
ID-SW-75-B	Slimduct - 75mm Wall Cover - Brown

WALL ROSETTE



Part code	Description
ID-SWC-100-I	Slimduct - 100mm Wall Rosette - Ivory
ID-SWC-100-W	Slimduct - 100mm Wall Rosette - White
ID-SWC-100-K	Slimduct - 100mm Wall Rosette - Black
ID-SWC-100-B	Slimduct - 100mm Wall Rosette - Brown
ID-SWC-75-I	Slimduct - 75mm Wall Rosette - Ivory
ID-SWC-75-W	Slimduct - 75mm Wall Rosette - White
ID-SWC-75-K	Slimduct - 75mm Wall Rosette - Black
ID-SWC-75-B	Slimduct - 75mm Wall Rosette Brown

WALL CAP

RAL COLOURS
 ■ BLACK: MUNSELL N-2.0
 ■ WHITE: MUNSELL N9.0
 ■ IVORY: MUNSELL 5Y8/1
 ■ BROWN: MUNSELL 10YR3

INABA DENKO TRUNKING

DUCT END



Part code	Description
ID-SEN-100-I	Slimduct - 100mm Duct End - Ivory
ID-SEN-100-W	Slimduct - 100mm Duct End - White
ID-SEN-100-K	Slimduct - 100mm Duct End - Black
ID-SEN-100-B	Slimduct - 100mm Duct End - Brown
ID-SE-75-I	Slimduct - 75mm Duct End - Ivory
ID-SE-75-W	Slimduct - 75mm Duct End - White
ID-SE-75-K	Slimduct - 75mm Duct End - Black
ID-SE-75-B	Slimduct - 75mm Duct End - Brown

OFFSET BEND



Part code	Description
ID-SIF-75-I	Slimduct - 75mm Offset bend - Ivory
ID-SIF-75-W	Slimduct - 75mm Offset bend - White
ID-SIF-75-K	Slimduct - 75mm Offset bend - Black
ID-SIF-75-B	Slimduct - 75mm Offset bend - Brown
ID-SIF-100-I	Slimduct - 100mm Offset bend - Ivory
ID-SIF-100-W	Slimduct - 100mm Offset bend - White
ID-SIF-100-K	Slimduct - 100mm Offset bend - Black
ID-SIF-100-B	Slimduct - 100mm Offset bend - Brown

DRAIN HOSE



Part code	Description
ID-DH-14	Drain Hose - Ivory-14mm (20mm box)
ID-DH-16	Drain Hose - Ivory-16mm (20mm box)

SLIM DUCT CUTTER



Part code	Description
ID-VD-2100	Slim Duct Cutter

RAL COLOURS
 **BLACK: MUNSELL N-2.0**
 **WHITE: MUNSELL N9.0**
 **IVORY: MUNSELL 5Y8/1**
 **BROWN: MUNSELL 10YR3**

TRUNKING

INABA DENKO TRUNKING

BIG TIE



Part code	Description
ID-BT-250	Bigtie - 250mm
ID-BT-350	Bigtie - 350mm

CEILING COVER



Part code	Description
ID-SP-100-I	Slimduct - 100mm Flat Rosette Ivory
ID-SP-100-W	Slimduct - 100mm Flat Rosette White
ID-SP-100-K	Slimduct - 100mm Flat Rosette Black
ID-SP-100-B	Slimduct - 100mm Flat Rosette Brown
ID-SP-75-I	Slimduct - 75mm Flat Rosette Ivory
ID-SP-75-W	Slimduct - 75mm Flat Rosette White
ID-SP-75-K	Slimduct - 75mm Flat Rosette Black
ID-SP-75-B	Slimduct - 75mm Flat Rosette Brown

TIE CLIP KIT



Part code	Description
ID-SL-300	Slimduct - Tie Clip

SPEEDICHANNEL TRUNKING

SpeediChannel® is a system used to house air conditioning refrigerant pipes and services. Made out of rigid PVC, the colours are fadeproof, UV resistant and fireproof. The trunking contributes to reducing energy consumption. Suitable for indoor and outdoor use, it can be painted to match its environment.



Description	Width	Ivory Part code	White Part code
Duct - 70mm - sold in 2 metre lengths	70mm	230-D3	230-D3W
Duct - 105mm - sold in 2 metre lengths	105mm	230-D4	230-D4W
Inside Elbow 90 Degree	70mm	230-EB3	230-EB3W
Inside Elbow 90 Degree	105mm	230-EB4	230-EB4W
Outside Elbow 90 Degree	70mm	230-EIN3	230-EIN3W
Outside Elbow 90 Degree	105mm	230-EIN4	230-EIN4W
Flat Bend 90 Degree	70mm	230-FB3	230-FB3W
Flat Bend 90 Degree	105mm	230-FB4	230-FB4W
Flat Bend 45 Degree	70mm	230-FB453	230-FB453W
Flat Bend 45 Degree	105mm	230-FB454	230-FB454W
Adjust Flat Bend 45-90 Degree	70mm	230-AFB3	230-AFB3W
Adjust Flat Bend 45-90 Degree	105mm	230-AFB4	230-AFB4W
Flexible Hose Kit	70mm	230-FH3-KIT	230-FH3W-KIT
Flexible Hose Kit	105mm	230-FH4-KIT	230-FH4W-KIT
Flat Rosette	70mm	230-FR3	230-FR3W
Flat Rosette	105mm	230-FR4	230-FR4W
Long Flat Elbow 90 Degree	70mm	230-LFB3	230-LFB3W
Long Flat Elbow 90 Degree	105mm	230-LFB4	230-LFB4W
Duct Cap	70mm	230-DC3	230-DC3W
Duct Cap	105mm	230-DC4	230-DC4W
Duct End	70mm	230-DE3	230-DE3W
Duct End	105mm	230-DE4	230-DE4W
Connection Piece	70mm	230-CP3	230-CP3W
Connection Piece	105mm	230-CP4	230-CP4W
Reducer Joint	105mm	230-RJ4	230-RJ4W
T Joint	105mm	230-TJ4	230-TJ4W
Soffit Inlet	70mm	230-SF3	230-SF3W
Soffit Inlet	105mm	230-SF4	230-SF4W
Wall Cover	70mm	230-WC3	230-WC3W
Wall Cover	105mm	230-WC4	230-WC4W
Wall Rosette	70mm	230-WR3	230-WR3W
Wall Rosette	105mm	230-WR4	230-WR4W

MOUNTING



FLEXI LITE SLAB AND FOOT KIT

A low cost, lightweight floor mounting solution for air conditioning equipment and air source heat pumps.

Easy to transport, locate and construct.

The kit comes complete with two anti-vibration feet, a lightweight slab and all the fixings

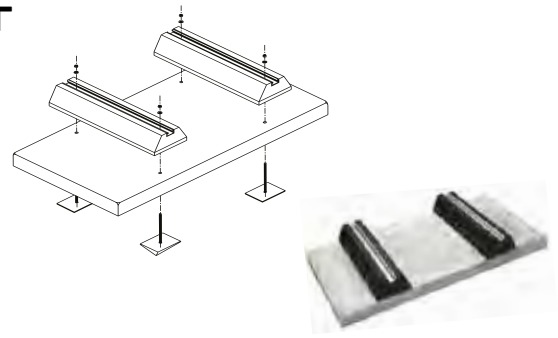

Part code	Description	Specifications
FF-UC3-S	Flexi Lite Kit - small	900 x 600 x 175
FF-UC3-M	Flexi Lite Kit - medium	1050 x 600 x 175
FF-UC3	Flexi-Lite Slab Kit	1200 x 600 x 175
FF-UC3-3	Flexi lite Slab Kit - 3 FEET	1200 x 600 x 175
FF-UC3-XL	Flexi-Lite Slab Kit - extra large	1650 x 865 x 175
FF-UC3-3XL	Flexi-Lite Slab Kit - 3 FEET - extra large	1525 x 915 x 75
FF-UC3-3XL-150	Flexi-Lite Slab Kit - 3 FEET (150mm feet) - extra large	1650 x 865 x 225



ULTRALITE® SLAB

Don't be fooled - Ultralite® Slabs look and perform like a concrete slab, starting at only 7kg, they are lightweight and very easy to handle and transport. So give your aching back a rest and use Ultralite® slabs to mount AC units and air source heat pumps.

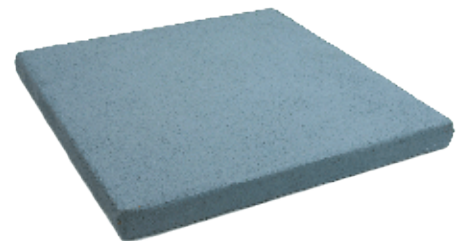

Part code	Description	Dimensions mm (HxWxD)	Weight	Safe working load*
UC1636-3	Ultralite equipment pad	75x400x900	7kg	300kg
UC2424-3	Ultralite equipment pad	75x600x600	7kg	300kg
UC2436-3	Ultralite equipment pad	75x600x900	12kg	485kg
UC2442-3	Ultralite equipment pad	75x600x1050	16kg	595kg
UC2448-3	Ultralite equipment pad	75x600x1200	16kg	700kg

ARE THESE DISCONTINUED?

MOUNTING BLOCKS

These mounting blocks are lightweight, 100% rust-free, UV stabilised and manufactured from reinforced PVC. Suitable for mounting air conditioning units and domestic air source heat pumps.

The blocks reduce vibration and are supplied with anti-slip strips on the base along with fixings for a simple rapid installation. End caps are available to provide a professional finish. CMB-350 & CMB-450 are sold in boxes of 12.

CMB-1000 are sold in pairs.

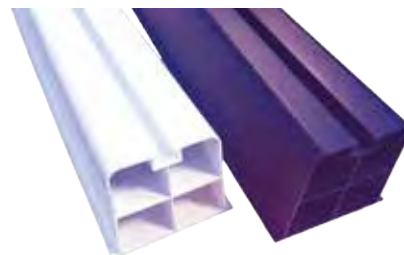

Part code (Black)	Part code (White)	Description	Dimensions mm (HxWxL)	Weight	"Safe Working Load**"
CMB-350		Mounting Blocks - 350mm	100x100x350	0.6kg	240kg
CMB-450	CMB-450-W	Mounting Blocks - 450mm	100x100x450	0.7kg	240kg
CMB-1000	CMB-1000-W	Mounting Blocks - 1000mm	100x100x1000	1.6kg	240kg

RUBBER AND CORK MOUNTING STRIPS (AND PADS)

Anti-vibration mounting strips / pads are a low cost option for mounting air conditioning units, air source heat pumps and other equipment, providing vibration reduction and sound dampening.

Available in recycled rubber and cork-rubber in various sizes. Rubber AVM Pad comes in three sizes (steel plates are in the larger sizes).



ANTI VIBRATION MOUNTING STRIPS

Part code	Description	Dimensions mm (WxL)	Thickness mm	Weight
AVMS-1	Anti-vibration Mounting Strip - Rubber	50x500	15	0.4kg
AVMS-2	Anti-vibration Mounting Strip - Rubber	75x1000	15	1kg
AVMS-3	Anti-vibration Mounting Strip - Rubber	75x1200	15	1.7kg
AVMS-4	Anti-vibration Mounting Strip - Rubber	100x1000	15	1.4kg
AVMS-CR-3	Anti-vibration Mounting Strip - Cork/Rubber	75x1200	12.5	0.8kg
AVMS-CR-4	Anti-vibration Mounting Strip - Cork/Rubber	100x1200	12.5	0.9kg

Part code	Description	Dimensions mm (HxWxL)	Weight	Safe Working Load*
AVM-PAD-1	Rubber AVM Pad - 330mm	45x300x300	3.2kg	200kg
AVM-PAD-2	Rubber AVM Pad - 600mm with steel plates	30x105x 600	2.8kg	150kg
AVM-PAD-3	Rubber AVM Pad - 1000mm with steel plates	30x500x1000	22kg	300kg

MOUNTING



EVA™ PADS / CORK RUBBER ANIT-VIBRATION PADS

EVA™ anti-vibration pads are designed to effectively eliminate vibrations and reduce noise levels from equipment such as compressors, condensing units and air source heat pumps. Out performing cork and rubber by 3:1, the EVA pad has a special composite foam centre and is resistant to most oils & chemicals.

The cork is laminated between two corrugated pads to reduce vibration and noise. Designed to withstand 3.5kg per cm³. Ideal for air conditioners, compressors, cooling towers or anywhere where vibration control is needed.

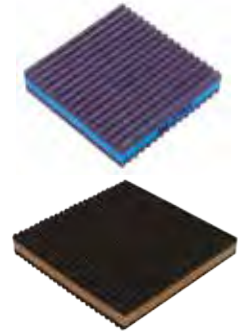

Part code EVA	Part code Cork / Rubber"	Description	Dimensions mm (HxWxL)	Weight	Safe Working Load*
MP-2E	MP-2C	Pad - 50mm	20x50x50	0.04kg	3.5kg per cm ²
MP-3E	MP-3C	Pad - 80mm	20x80x80	0.08kg	3.5kg per cm ²
MP-4E	MP-4C	Pad - 100mm	20x100x100	0.1kg	3.5kg per cm ²
MP-6E	MP-6C	Pad - 150mm	20x150x150	0.3kg	3.5kg per cm ²
MP-12E	MP-12C	Pad - 305mm	20x305x305	1.4kg	3.5kg per cm ²
MP-18E	MP-18C	Pad - 460mm	20x460x460	3kg	3.5kg per cm ²

RUBBER ANTI-VIBRATION PAD

Highest quality oil resistant pads, designed to withstand 3.5kg per cm³. The rubber pads are corrugated on both sides. Ideal for air conditioners, compressors or anywhere where vibration control is needed.



Part code	Description	Dimensions mm (HxWxL)	Weight	Safe Working Load*
MP-2	Rubber Anti-vibration Pad - 50mm	9.5x50x50	0.04kg	3.5kg per cm ²
MP-3	Rubber Anti-vibration Pad - 80mm	10x80x80	0.05kg	3.5kg per cm ²
MP-4	Rubber Anti-vibration Pad - 100mm	10x100x100	0.1kg	3.5kg per cm ²
MP-6	Rubber Anti-vibration Pad - 150mm	10x150x150	0.2kg	3.5kg per cm ²
MP-18	Rubber Anti-vibration Pad - 460mm	10x460x460	1.8kg	3.5kg per cm ²

ISO-CUBE ANTI-VIBRATION PADS

Natural rubber pads, designed to reduce vibration and noise emanating from refrigeration and air conditioning equipment. The circular design in each pad offers a suction cup effect, which eliminates the need to bolt the pads down. A standard 18" (46cm) pad is divided into eighty-one 2" (5cm) segments, each of which may be cut or torn to provide smaller pads.



Part code	Description	Dimensions mm (HxWxL)	Weight	Safe Working Load*
ISO-4	ISO Cube Natural Rubber Pads - 100mm	20x100x100	0.18kg	12.6kg per cm ²
ISO-18	ISO Cube Natural Rubber Pads- 460mm	20x460x460	3.8kg	12.6kg per cm ²

QUICK SLING®

Quick Sling stands offer light and easy-assembly support for outdoor a/c condensing units and heat pumps. Ideal for raising the condensing unit height in surface installations. The elevated height allows for ease of installation, maintenance and service. Available in three height options.

- Flat-packed for easy handling, transport and storage
- Quick and easy to assemble
- Adjustable to suit outdoor units with fixing feet centres up to 700mm (L) and 430mm (W)
- Each 150mm square foot is height adjustable (up to 30mm) to accommodate uneven surfaces
- Includes anti-vibration mounting bolts
- Epoxy powder coated finish



Part code	Description	Length mm	Width mm	Height mm	"Safe Working Load"	Weight
QSMS1201	Quick Sling Stand - Low	1056	941	305	180kg	10kg
QSMS1801	Quick Sling Stand - Medium	1056	941	450	180kg	13kg
QSMS2401	Quick Sling Stand - High	1056	941	600	180kg	16kg

PORTABLES



PORTABLES - COOL ONLY & HEAT / COOL PUMP

A energy efficiency

The portable air conditioners are suitable for offices, computer rooms and light commercial use. The cooling only model is ideal for cooling flats, conservatories or loft conversions during hot summer months. The heat and cool model can be used as an energy efficient form of heating along with cooling. The units come with a hose, tray, remote control and wall kit. Spare parts are available upon request - please enquire for more details.



PAC-C-12-R290

Part code	Description	Cool capacity Btu/kW	Heat capacity Btu/kW	Watts	Amps	Air flow volume	EER	COP	Sound power level dBA
PAC-C-12-R290	Portable (cooling)	12,000 / 3.5	N/A	1350	5.9	420m ³ /h	2.6	N/A	56
PAC-H-12-R290	Portable (heat pump)	12,000 / 3.5	N/A	1350	5.9	420m ³ /h	2.6	N/A	56

Part code	Description	Height	Width	Depth	Weight	Hose length	Refrigerant	Cooling area
PAC-C-12-R290	Portable (cooling)	730mm	485mm	360mm	28kg	1.5m	R290	25-30m ²
PAC-H-12-R290	Portable (heat pump)	730mm	485mm	360mm	28kg	1.5m	R290	25-30m ²

WALL AIR CONDITIONER

Wall air conditioners, also known as through-the-wall or in-wall air conditioners, are designed to be a long-lasting fixture. These 12,000 btu 3.5kW air conditioners are mounted into a hole in the wall as a permanent installation. Meets EN14511 standard and EU commission regulation 206/2012. R32 Refrigerant. Supplied with remote controller, this proven, well tested design is suitable for areas up to 23m³.



Part code	Description	Cool Capacity Btu / kW	Watts	Amps	Air Flow Volume
WAC-C-12-INV	Through-the-wall AC	12,000 / 3.5	1100	5.1	400m ³ /h

Part code	Description	Height	Width	Depth	Weight	Refrigerant	Cooling Area
WAC-C-12-INV	Through-the-wall AC	400mm	560mm	670mm	42kg	R32	16-23m ²

UNIVERSAL REMOTE CONTROLLER

This universal air-conditioning remote controller is compatible with units from all major air conditioning manufacturers. This easy to use, time saving tool is perfect for maintaining and servicing any air conditioning unit.



Part code	Max range	Batteries	Length	Width	Height	Weight
KT-1028	8m	AAA x 2	130mm	46mm	16mm	50g

CUSHION CLAMPS

Cushion Clamps are the industry established method of supporting copper refrigerant tube, especially for multiple pipe runs. The zinc dichromate plating provides excellent corrosion resistance and the polymer insert ensures a positive grip, absorbs shock and vibration and prevents galvanic corrosion.



Part code	Pipe Diameter	Pack qty	Part code	Pipe Diameter	Pack qty
CC-004	1/4	10	CC-022	1-3/8	10
CC-006	3/8	10	CC-026	1-5/8	10
CC-008	1/2	10	CC-034	2-1/8	5
CC-010	5/8	10	CC-042	2-5/8	5
CC-012	3/4	10	CC-050	3-1/8	5
CC-014	7/8	10	CC-058	3-5/8	5
CC-018	1-1/8	10	CC-066	4-1/8	5

THREADED ROD HANGERS

These clamps support a pair of flow and return insulated copper air conditioning pipes on either M8 or M10 threaded rod. By simply squeezing the tips together, the spring steel rod hanger can be fitted or adjusted in seconds, even after the refrigerant pipes have been installed. Black zinc coating matches the insulation colour and offers corrosion resistance.



Part code	Description	Liquid Pipe Diameter (inches)	Gas Pipe Diameter (inches)	Threaded Rod Diameter (inches)	Pack QTY
TRH-1	Threaded Rod Hanger - Size 1	1/4	1/2	M8/M10	10
TRH-2	Threaded Rod Hanger - Size 2	3/8	5/8	M8/M10	10
TRH-3	Threaded Rod Hanger - Size 3	1/2	7/8	M8/M10	10
TRH-4	Threaded Rod Hanger - Size 4	5/8	1-1/8	M8/M10	10

GRIP FIT CLAMPS

The asymmetric design provides a perfect fit for any one of four pairs of flow and return insulated refrigerant pipes. An 8mm hole allows the clamps to be fixed directly to any flat surface, such as a wall or ceiling. The hinged design allows the product to be installed quickly.



Part code	Description	Liquid Pipe Diameter (inches)	Gas Pipe Diameter (inches)	Pack QTY
GFC-1	Grip Fit Clamp - Size 1	1/4	1/2	10
GFC-2	Grip Fit Clamp - Size 2	3/8	5/8	10
GFC-3	Grip Fit Clamp - Size 3	1/2	7/8	10
GFC-4	Grip Fit Clamp - Size 4	5/8	1-1/8	10

CLAMPS AND CLIPS



BACK PLATE 810-HD

Back plate for mounting M8/M10 threaded rod. Secure threaded rod to a wall or ceiling safely.

Our Back Plate is used for Mounting M8 / M10 Threaded Rod safely to a wall or ceiling. Made from zinc plated steel, this back plate has a thickness of 3mm and comes in a box of 50.



Part code	Description	Material	Length	Width	Quantity
BackPlate-810-HD	Back Plate for Mounting M8/M10 Threaded Rod	2.5mm Zinc Plated Steel	80	30	50

K-KLAMP - PIPE AND INSULATION CLAMP

Back plate for mounting M8/M10 threaded rod. Secure threaded rod to a wall or ceiling safely.

Our Back Plate is used for Mounting M8 / M10 Threaded Rod safely to a wall or ceiling. Made from zinc plated steel, this back plate has a thickness of 3mm and comes in a box of 50.



Part code	Insulation wall thickness			
	3/8"	1/2"	3/4"	1"
1/4"	K38-14	-	K34-14	-
3/8"	K38-38	K12-38	K34-38	-
1/2"	K38-12	K12-12	K34-12	K100-12
5/8"	K38-58	K12-58	K34-58	K100-58
3/4"	K38-34	K12-34	K34-34	K100-34
7/8"	K38-78	K12-78	K34-78	K100-78
1"	K38-100	K12-100	-	-
1-1/8"	K38-118	K12-118	K34-118	K100-118
1-3/8"	K38-138	K12-138	K34-138	K100-138
1-5/8"	K38-158	K12-158	K34-158	K100-158
2-1/8"	K38-218	K12-218	K34-218	K100-218
2-5/8"	-	K12-258	K34-258	K100-258
3-1/8"	-	K12-318	K34-318	K100-318
3-5/8"	-	K12-358	K34-358	K100-358
4-1/8"	-	K12-418	K34-418	K100-418

Klo-Shure Part code	Discharge size (inches)
729037	Klo-Shure 3/8" ID x 1-1/2"
729050	Klo-Shure 1/2" ID x 1-1/2"
729062	Klo-Shure 5/8" ID x 1-1/2"
729087	Klo-Shure 7/8" ID x 1-1/2"
729112	Klo-Shure 1-1/8" ID x 1-1/2"
729137	Klo-Shure 1-3/8" ID x 1-1/2"
729162	Klo-Shure 1-5/8" ID x 1-1/2"
729212	Klo-Shure 2-1/8" ID x 1-1/2"
729262	Klo-Shure 2-5/8" ID x 1-1/2"
729312	Klo-Shure 3-1/8" ID x 1-1/2"
729412	Klo-Shure 4-1/8" ID x 1-1/2"

HINGED LINED PIPE CLAMP



These hinged lined pipe clamps are suitable for supporting all types of pipe work including HVAC, boiler and drain. They come with noise suppressing rubber strips: 17dB(A) according to ISO 3822-1.

Part code	Description	Quantity
RLC-020-GS	Single Hinged Pipe Clamp M8-10 lined 3/8" 15-19mm	Box of 50
RLC-024-GS	Single Hinged Pipe Clamp M8-10 lined 1/2" 20-24mm	Box of 50
RLC-029-GS	Single Hinged Pipe Clamp M8-10 lined 3/4" 25-29mm	Box of 50
RLC-035-GS	Single Hinged Pipe Clamp M8-10 lined 1" 32-36mm	Box of 50
RLC-042-GS	Single Hinged Pipe Clamp M8-10 lined 1-1/4" 40-45mm	Box of 50
RLC-053-GS	Single Hinged Pipe Clamp M8-10 lined 1-1/2" 48-53mm	Box of 50
RLC-065-GS	Single Hinged Pipe Clamp M8-10 Lined 2" 58-63mm	Box of 50

RUBBER-LINED UNIVERSAL PIPE CLAMP

The M8-M10 rubber-lined pipe clamp are suitable for supporting all types of pipework including HVAC, boiler and drain. They come with noise suppressing rubber strips: 17dB(A) according to ISO 3822-1.



Part code	Description	Quantity
RLC-015	Pipe Clamp M8-10 Rubber lined 1/4" 11/15mm	Box of 50
RLC-020	Pipe Clamp M8-10 lined 3/8" 14-19mm	Box of 50
RLC-024	Pipe Clamp M8-10 lined 1/2" 20-24mm	Box of 50
RLC-029	Pipe Clamp M8-10 lined 3/4" 25-29mm	Box of 50
RLC-035	Pipe Clamp M8-10 lined 1" 32-36mm	Box of 50
RLC-044	Pipe Clamp M8-10 lined 1-1/4" 37-44mm	Box of 50
RLC-050	Pipe Clamp M8-10 lined 1-1/2" 44-50mm	Box of 50
RLC-058	Pipe Clamp M8-10 lined 50-58mm	Box of 50
RLC-068	Pipe Clamp M8-10 lined 2" 58-68mm	Box of 50
RLC-078	Pipe Clamp M8-10 lined 2-1/2" 68-78mm	Box of 50
RLC-088	Pipe Clamp M8-10 lined 78-88mm	Box of 50
RLC-098	Pipe Clamp M8-10 lined 3" 88-98mm	Box of 25
RLC-108	Pipe Clamp M8-10 lined 3-1/2" 98-108mm	Box of 25
RLC-118	Pipe Clamp M8-10 lined 4" 108-118mm	Box of 25
RLC-128	Pipe Clamp M8-10 lined 118-128mm	Box of 25
RLC-138	Pipe Clamp M8-10 lined 128-138mm	Box of 25
RLC-148	Pipe Clamp M8-10 lined 135-148mm	Box of 25
RLC-164	Pipe Clamp M8-10 lined 151-164mm	Box of 25
RLC-175	Pipe Clamp M8-10 lined 6" 165-175mm	Box of 10
RLC-185	Pipe Clamp M8-10 lined 175-185mm	Box of 10
RLC-205	Pipe Clamp M8-10 lined 194-205mm	Box of 10

CLAMPS AND CLIPS



RPC CHANNEL CLIPS



The RPC channel clip fits around the pipe and insulation. Ideal for multiple pipe runs, the one piece composite (nylon) alloy clamp absorbs shock and vibration. Quick and easy to install and suitable for temperatures -40°C to +140°C.



Part code	Description	Tube OD (inches)	Pack QTY
RPC-0014	RPC Channel Clip	1/4	10
RPC-0038	RPC Channel Clip	3/8	10
RPC-0012	RPC Channel Clip	1/2	10
RPC-0058	RPC Channel Clip	5/8	10
RPC-0034	RPC Channel Clip	3/4	10
RPC-0078	RPC Channel Clip	7/8	10
RPC-0118	RPC Channel Clip	1-1/8	10
RPC-0138	RPC Channel Clip	1-3/8	10
RPC-0158	RPC Channel Clip	1-5/8	10

RPC INSULCLIPS



The InsulClips allows an uninterrupted vapour seal and eliminates the problem of sweating on metal fittings. This makes the InsulClip the ideal product to secure the installation of the refrigerant pipes, allowing the vapour seal to run the length of the pipework without cutting the insulation material. Made from a composite polyamide (nylon) alloy, which has similar tensile strength properties to nylon but better impact strength, especially at low temperatures.



Part code	Tube OD (inches)	Pack QTY
IC00-15	5/8	10
IC00-20	3/4	10
IC00-22	7/8	10
IC00-25	1	10
IC00-28	1-1/8	10
IC00-32	1-1/4	10
IC00-35	1-3/8	10
IC00-40	1-1/2	10
IC00-42	1-5/8	10
IC00-50	2	10
IC00-54	2-1/8	10

RPC FLAT SURFACE MOUNT ADAPTOR (RPC-FB-B)



RPC STUDDING CLIPS



The studding clips from RPC have a unique way of attaching themselves to the threaded rod.

Simply insert the clip and snap to secure. The ratchet design locks the pipework in place. It will overcome the problems of using cable ties for piping, electrical, optical and network cabling.

Part code	Stud Size	Tube OD (inches)	Pack QTY
SC08-15	Studding Clip M8	5/8	10
SC08-20	Studding Clip M8	3/4	10
SC08-22	Studding Clip M8	7/8	10
SC08-25	Studding Clip M8	1	10
SC08-28	Studding Clip M8	1-1/8	10
SC08-32	Studding Clip M8	1-1/4	10
SC08-35	Studding Clip M8	1-3/8	10
SC08-40	Studding Clip M8	1-1/2	10
SC08-42	Studding Clip M8	1-5/8	10
SC08-50	Studding Clip M8	2	10
SC08-54	Studding Clip M8	2-1/8	10

Part code	Stud Size	Tube OD (inches)	Pack QTY
SC10-15	Studding Clip M10	5/8	10
SC10-20	Studding Clip M10	3/4	10
SC10-22	Studding Clip M10	7/8	10
SC10-25	Studding Clip M10	1	10
SC10-28	Studding Clip M10	1-1/8	10
SC10-32	Studding Clip M10	1-1/4	10
SC10-35	Studding Clip M10	1-3/8	10
SC10-40	Studding Clip M10	1-1/2	10
SC10-42	Studding Clip M10	1-5/8	10
SC10-50	Studding Clip M10	2	10
SC10-54	Studding Clip M10	2-1/8	10

Part code	Description	Tube OD (inches)	Pack QTY
SC06-15	M6 Stud Clip - 5/8"	5/8	10
SC06-20	M6 Stud Clip - 3/4"	3/4	10
SC06-22	M6 Stud Clip - 7/8"	7/8	10
SC06-25	M6 Stud Clip - 1"	1	10
SC06-28	M6 Stud Clip - 1-1/8"	1-1/8	10

Part code	Description	Tube OD (inches)	Pack QTY
SC06-32	M6 Stud Clip - 1-1/4"	1-1/4	10
SC06-35	M6 Stud Clip - 1-3/8"	1-3/8	10
SC06-40	M6 Stud Clip - 1-1/2"	1-1/2	10
SC06-42	M6 Stud Clip - 1-5/8"	1-5/8	10
SC06-50	M6 Stud Clip - 2"	2	10
SC06-54	M6 Stud Clip - 2-1/8"	2-1/8	10

RPC CABLE TIE CLIPS



Channel cable tie clips accommodate PVC or metal cable ties up to a width of 17mm. They come in three support base lengths of 50, 65 and 80mm. The channel clips are secured on the channel with a twist lock motion, ready for the cable tie to be inserted to secure the refrigeration pipework.

Clips can be used in temperatures ranging from -40 to 140°C. They have a melting point of 220°C. They can withstand pressures up to 40 MPa, with less than 4% deformation, and provide high resistance to mechanical stress creep. As well as resisting all known solvents, the clips have a low moisture sensitivity.

They also have stable electrical and vibration properties and a high resistance to UV light.

Part code	Size (mm)	Pack QTY
CTC-050	50	10
CTC-065	65	10
CTC-080	80	10



INSERT INTO CHANNEL



TWIST CLOCKWISE



LOCK TO SECURE

BRASS FITTINGS



SHORT MACHINE FLARE NUT



Part code	Size (inches)	Pack QTY
DN1-3	3/16	10
DN1-4	1/4	10
DN1-5	5/16	10
DN1-6	3/8	10
DN1-8	1/2	10
DN1-10	5/8	10
DN1-12	3/4	10
DN1-14	7/8	5

SHORT FORGED FLARE NUT



Part code	Size (inches)	Pack QTY
DNS4-4	1/4	10
DNS4-6	3/8	10
DNS4-8	1/2	10
DNS4-10	5/8	10
DNS4-12	3/4	10
DNS4-14	7/8	5

FLARE TEE



Part code	Size (inches)	Pack QTY
DT2-4	1/4	10
DT2-6	3/8	10
DT2-8	1/2	10
DT2-10	5/8	10

CAP



Part code	Size (inches)	Pack QTY
DN5-4	1/4	10
DN5-6	3/8	10

PLUG



Part code	Size (inches)	Pack QTY
DP2-4	1/4	10
DP2-6	3/8	10
DP2-8	1/2	10
DP2-10	5/8	10

FLARE AND MPT ELBOW



Part code	Size (inches)	Pack QTY
DE1-4B	1/4	10
DE1-6C	3/8	10
DE1-8D	1/2	10
DE1-12E	5/8	10

FLARE & MPT ELBOW



Part code	Size (inches)	Pack QTY
DE1-6B	3/8 x 1/4 MPT	10
DE1-6D	3/8 x 1/2 MPT	10
DE1-8E	1/2 x 3/4 MPT	10
DE1-10D	5/8 x 1/2 MPT	10
DE1-12D	3/4 x 1/2 MPT	10

FLARE UNION



Part code	Size (inches)	Pack QTY
DU2-4	1/4	10
DU2-6	3/8	10
DU2-8	1/2	10
DU2-10	5/8	10
DU2-12	3/4	10

R410A & R32 TRANSITIONAL FITTING



Part code	Size (inches)	Pack QTY
20128	5/16 x 1/4	1

FLARE UNION X MPT



Part code	Size (inches)	Pack QTY
DU1-4A	1/4 x 1/8 MPT	10
DU1-4B	1/4 x 1/4 MPT	10
DU1-6B	3/8 x 1/4 MPT	10
DU1-6C	3/8 x 3/8 MPT	10
DU1-6D	3/8 x 1/2 MPT	10
DU1-6E	3/8 x 3/4 MPT	10
DU1-8B	1/2 x 1/4 MPT	10
DU1-8C	1/2 x 3/8 MPT	10
DU1-8D	1/2 x 1/2 MPT	10
DU1-8E	1/2 x 3/4 MPT	10
DU1-10D	5/8 x 1/2 MPT	10
DU1-10E	5/8 x 3/4 MPT	10
DU1-12D	3/4 x 1/2 MPT	10
DU1-12E	3/4 x 3/4 MPT	10

FLARE X FLARE SWIVEL UNION



Part code	Size (inches)	Pack QTY
DUS4-4	1/4 x 1/4	10
DUS4-6	3/8 x 3/8	10
DUS4-8	1/2 x 1/2	10

FLARE X FPT UNION



Part code	Size (inches)	Pack QTY
DU3-6C	3/8 x 3/8 FPT	10
DU3-6D	3/8 x 1/2 FPT	10
DU3-8C	1/2 x 3/8 FPT	10
DU3-8D	1/2 x 1/2 FPT	10
DU3-10D	5/8 x 1/2 FPT	10
DU3-10E	5/8 x 3/4 FPT	10

ACCESS FITTINGS



VAU-24



VST-46



VST-44X



VA-3-346



VTR-24

Code	Description	Size (inches)	Pack QTY
VA-3-346	3-Way Solder Fitting	3/16 OD to 1/4 & 3/8	6
VA-34	Straight Solder Fitting	3/16 ODS x 1/4 ODF	6
VA-46	Straight Solder Fitting	1/4 ODS x 3/8 ODF	6
VA-68	Straight Solder Fitting	3/8 ODS x 1/2 ODF	6
VAU-24	Half Union	1/8 MPT	6
VAU-45	Half Union	1/4 MPT	6
VAX-3	Extended Copper Tube Fitting	1/4 SAE Flare with 3/16 OD x 1/8 ID with 2inch tail	6
VAX-4	Extended Copper Tube Fitting	1/4 SAE Flare with 1/4 OD x 3/16 ID with 2inch tail	6
VAX-4B	Extended Copper Tube Fitting	1/4 SAE Flare with 1/4 OD x 3/16 ID with 2inch tail	100
VAX-4B-6	Extended Copper Tube Fitting	1/4 SAE Flare with 1/4 OD x 3/16 ID with 6inch tail	1
VAX-5	Extended Copper Tube Fitting	1/4 SAE Flare with 5/16 OD x 1/4 ID with 2inch tail	3
VAX-5-PH	Extended Copper Tube Fitting	5/16 SAE Flare (R410a) with 1/4 OD x 3/16 ID with 2inch tail	1
VAX-6	Extended Copper Tube Fitting	1/4 SAE Flare with 3/8 OD x 5/16 ID with 2inch tail	3
VC-4	SAE Flare Cap 1/4	Plain Cap	12
VC-4R	SAE Flare Cap 1/4	Cap with Core Remover	12
VS-4	Access Fitting - Female Flare	Female 1/4 SAE Swivel Nut w /Depressor x 1/4 SAE male flare	3
VST-4	Swivel Tee 1/4	1/4 SAE Flare x 1/4 SAE Flare on run x 1/4 Female Swivel on branch	3
VST-44	Swivel Tee 1/4	1/4 SAE Flare x 1/4 Female Swivel on run x 1/4 SAE Flare on branch	3
VST-4X	Swivel Tee 1/4 with depressor	1/4 SAE Flare x 1/4 SAE Flare on run x 1/4 Female Swivel on branch	3
VST-44X	Swivel Tee 1/4 with depressor	1/4 SAE Flare x 1/4 Female Swivel on run x 1/4 SAE Flare on branch	3
VTR-24	Threaded Tee Fitting	1/8 MPT x 1/4 Male SAE Flare on run x 1/4 SAE Male Flare on branch	3
VTS-10	Solder Tee Fitting	5/8 ODS x 5/8 ODS on run with 1/4 SAE Male Flare on branch	3
VTS-46	Solder Tee Fitting	1/4 ODS x 1/4 ODS on run with 1/4 SAE Male Flare on branch	3
VTS-68	Solder Tee Fitting	3/8 ODS x 3/8 ODS on run with 1/4 SAE Male Flare on branch	3
VTS-810	Solder Tee Fitting	1/2 ODS x 1/2 ODS on run with 1/4 SAE Male Flare on branch	3
VUR-4	Full Union	1/4 OD SAE Flare x 1/4 SAE Flare with Cap	6
MSA-44	Adaptor - SAE Female to MNPT	1/4 SAE Female Swivel x 1/4 MNPT	2
VVC-1	Replacement Valve Core Tool		6
VCR-1	Core Removal Tool & Storer		1
VCR-T-1	Core Removal Tool		1

WHAT IS DISCONTINUED ON THIS PAGE?

COPPER FITTINGS



90° ELBOW (CXC)



Part code	Size (inches)	Pack QTY
C235-0001-PH	1/4	100
C235-0002-PH	3/8	100
C235-0025-PH	1/2	100
C235-0050-PH	5/8	100
C235-0090-PH	3/4	50
C235-0100-PH	7/8	50
C235-0150-PH	1-1/8	25
C235-0215-PH	1-3/8	10
C235-0295-PH	1-5/8	10
C235-0390-PH	2-1/8	1
C235-0520-PH	2-5/8	1
C235-0650-PH	3-1/8	1
C235-0750-PH	3-5/8	1
C235-0850-PH	4-1/8	1

90° STREET ELBOW (FXC)



Part code	Size (inches)	Pack QTY
C254-0002-PH	3/8	100
C254-0002-PH	1/2	100
C254-0002-PH	5/8	100
C254-0002-PH	3/4	50
C254-0002-PH	7/8	25
C254-0002-PH	1-1/8	20
C254-0002-PH	1-3/8	10
C254-0002-PH	1-5/8	10
C254-0002-PH	2-1/8	1
C254-0002-PH	2-5/8	1
C254-0002-PH	3-1/8	1
C254-0002-PH	3-5/8	1
C254-0002-PH	4-1/8	1
C235-0850-PH	4-1/8	1

90° LONG TURN ELBOW (CXC)



Part code	Size (inches)	Pack QTY
C242-0001-PH	1/4	100
C242-0002-PH	3/8	100
C242-0025-PH	1/2	100
C242-0050-PH	5/8	50
C242-0090-PH	3/4	50
C242-0100-PH	7/8	25
C242-0150-PH	1-1/8	10
C242-0215-PH	1-3/8	10
C242-0295-PH	1-5/8	5
C242-0390-PH	2-1/8	1
C242-0520-PH	2-5/8	1
C242-0650-PH	3-1/8	1
C242-0750-PH	3-5/8	1
C242-0850-PH	4-1/8	1

90° LONG TURN STREET ELBOW (FXC)



Part code	Size (inches)	Pack QTY
C272-0002-PH	3/8	100
C272-0025-PH	1/2	100
C272-0050-PH	5/8	50
C272-0090-PH	3/4	50
C272-0100-PH	7/8	25
C272-0150-PH	1-1/8	10
C272-0215-PH	1-3/8	10
C272-0295-PH	1-5/8	5
C272-0390-PH	2-1/8	1
C272-0520-PH	2-5/8	1
C272-0650-PH	3-1/8	1
C272-0750-PH	3-5/8	1
C272-0850-PH	4-1/8	1
C242-0850-PH	4-1/8	1

COPPER FITTINGS



45° ELBOW (CXC)



Part code	Size (inches)	Pack QTY
C290-0002-PH	3/8	100
C290-0025-PH	1/2	100
C290-0050-PH	5/8	50
C290-0090-PH	3/4	50
C290-0100-PH	7/8	50
C290-0150-PH	1-1/8	25
C290-0215-PH	1-3/8	10
C290-0295-PH	1-5/8	10
C290-0390-PH	2-1/8	1
C290-0520-PH	2-5/8	1
C290-0650-PH	3-1/8	1
C290-0750-PH	3-5/8	1
C290-0850-PH	4-1/8	1

45° STREET ELBOW (FXC)



Part code	Size (inches)	Pack QTY
C295-0002-PH	3/8	100
C295-0025-PH	1/2	100
C295-0050-PH	5/8	50
C295-0090-PH	3/4	50
C295-0100-PH	7/8	25
C295-0150-PH	1-1/8	20
C295-0215-PH	1-3/8	10
C295-0295-PH	1-5/8	5
C295-0390-PH	2-1/8	1
C295-0520-PH	2-5/8	1
C295-0650-PH	3-1/8	1
C295-0750-PH	3-5/8	1
C295-0850-PH	4-1/8	1

END CAP



Part code	Size (inches)	Pack QTY
C154-0002-PH	3/8	100
C154-0025-PH	1/2	100
C154-0050-PH	5/8	50
C154-0090-PH	3/4	50
C154-0100-PH	7/8	25
C154-0150-PH	1-1/8	25
C154-0215-PH	1-3/8	10
C154-0295-PH	1-5/8	10
C154-0390-PH	2-1/8	5
C154-0520-PH	2-5/8	1
C154-0650-PH	3-1/8	1
C154-0750-PH	3-5/8	1
C154-0850-PH	4-1/8	1

STRAIGHT COUPLER (CXC)



Part code	Size (inches)	Pack QTY
C165-0001-PH	1/4 x 1/4	100
C165-0002-PH	3/8 x 3/8	100
C165-0025-PH	1/2 x 1/2	100
C165-0050-PH	5/8 x 5/8	100
C165-0090-PH	3/4 x 3/4	100
C165-0100-PH	7/8 x 7/8	50
C165-0150-PH	1-1/8 x 1-1/8	25
C165-0215-PH	1-3/8 x 1-3/8	25
C165-0295-PH	1-5/8 x 1-5/8	10
C165-0390-PH	2-1/8 x 2-1/8	5
C165-0520-PH	2-5/8 x 2-5/8	1
C165-0650-PH	3-1/8 x 3-1/8	1
C165-0750-PH	3-5/8 x 3-5/8	1
C165-0850-PH	4-1/8 x 4-1/8	1

COPPER FITTINGS



REDUCER COUPLER (CXC)



Part code	Size (inches)		Pack QTY
	1	2	
C165-0007-PH	3/8	1/4	100
C165-0032-PH	1/2	3/8	100
C165-0033-PH	1/2	1/4	100
C165-0058-PH	5/8	1/2	100
C165-0059-PH	5/8	3/8	100
C165-0093-PH	3/4	5/8	50
C165-0094-PH	3/4	1/2	100
C165-0107-PH	7/8	5/8	50
C165-0108-PH	7/8	1/2	50
C165-0149-PH	7/8	3/4	50
C165-0159-PH	1-1/8	7/8	25
C165-0160-PH	1-1/8	5/8	25
C165-0161-PH	1-1/8	1/2	25
C165-1498-PH	1-1/8	3/4	25
C165-0222-PH	1-3/8	1-1/8	25
C165-0223-PH	1-3/8	7/8	25
C165-0224-PH	1-3/8	5/8	10
C165-0030-PH	1-5/8	1-3/8	10
C165-0304-PH	1-5/8	1-1/8	10
C165-0305-PH	1-5/8	7/8	10
C165-0398-PH	2-1/8	1-5/8	10
C165-0399-PH	2-1/8	1-3/8	10
C165-0400-PH	2-1/8	1-1/8	10
C165-0401-PH	2-1/8	7/8	10
C165-0531-PH	2-5/8	2-1/8	1
C165-0532-PH	2-5/8	1-5/8	1
C165-0533-PH	2-5/8	1-3/8	1
C165-0662-PH	3-1/8	2-5/8	1
C165-0663-PH	3-1/8	2-1/8	1
C165-0664-PH	3-1/8	1-5/8	1
C165-0790-PH	3-5/8	3-1/8	1
C165-0852-PH	4-1/8	2-5/8	1

REDUCER COUPLER (FXC)



Part code	Size (inches)		Pack QTY
	1	2	
C410-0007-PH	3/8	1/4	100
C410-0032-PH	1/2	3/8	100
C410-0033-PH	1/2	1/4	100
C410-0058-PH	5/8	1/2	100
C410-0059-PH	5/8	3/8	100
C410-0093-PH	3/4	5/8	50
C410-0094-PH	3/4	1/2	50
C410-0095-PH	3/4	3/8	50
C410-0107-PH	7/8	5/8	50
C410-0108-PH	7/8	1/2	50
C410-0109-PH	7/8	3/8	50
C410-0149-PH	7/8	3/4	50
C410-0159-PH	1-1/8	7/8	25
C410-1498-PH	1-1/8	3/4	25
C410-0160-PH	1-1/8	5/8	25
C410-0161-PH	1-1/8	1/2	25
C410-0222-PH	1-3/8	1-1/8	25
C410-0223-PH	1-3/8	7/8	25
C410-0224-PH	1-3/8	5/8	25
C410-0303-PH	1-5/8	1-3/8	10
C410-0304-PH	1-5/8	1-1/8	10
C410-0305-PH	1-5/8	7/8	10
C410-0306-PH	1-5/8	5/8	10
C410-0398-PH	2-1/8	1-5/8	10
C410-0399-PH	2-1/8	1-3/8	10
C410-0400-PH	2-1/8	1-1/8	10
C410-0401-PH	2-1/8	7/8	10
C410-0402-PH	2-1/8	5/8	10
C410-0531-PH	2-5/8	2-1/8	1
C410-0532-PH	2-5/8	1-5/8	1
C410-0533-PH	2-5/8	1-3/8	1
C410-0662-PH	3-1/8	2-5/8	1
C410-0663-PH	3-1/8	2-1/8	1
C410-0664-PH	3-1/8	1-5/8	1
C410-0754-PH	3-5/8	3-1/8	1
C410-0850-PH	4-1/8	2-1/8	1
C410-0852-PH	4-1/8	2-5/8	1
C410-0854-PH	4-1/8	3-1/8	1

180° RETURN BEND



Part code	Size (inches)	Pack QTY
C180-0002-PH	3/8	100
C180-0025-PH	1/2	100
C180-0050-PH	5/8	50
C180-0090-PH	3/4	50
C180-0100-PH	7/8	50
C180-0150-PH	1-1/8	50
C180-0215-PH	1-3/8	25
C180-0295-PH	1-5/8	25
C180-0390-PH	2-1/8	25
C101-0215-PH	1-3/8	5
C101-0295-PH	1-5/8	2
C101-0390-PH	2-1/8	1

P TRAP



Part code	Size (inches)	Pack QTY
C533-0050-PH	5/8	5
C533-0090-PH	3/4	2
C533-0100-PH	7/8	2
C533-0150-PH	1-1/8	1
C533-0215-PH	1-3/8	1
C533-0295-PH	1-5/8	1
C533-0390-PH	2-1/8	1

COPPER FITTINGS



MALE ADAPTOR (C X MALE NPT)



Part code	Size (inches)		Pack QTY
	1	2	
C101-0005-PH	3/8	1/2	50
C101-0007-PH	3/8	1/8	50
C101-0025-PH	1/2	3/8	50
C101-0050-PH	5/8	1/2	50
C101-0057-PH	5/8	3/4	50
C101-0058-PH	5/8	3/8	50
C101-0100-PH	7/8	3/4	10
C101-0150-PH	1-1/8	1	5
C101-0159-PH	1-1/8	3/4	5
C101-0215-PH	1-3/8	1-1/4	5
C101-0295-PH	1-5/8	1-1/2	2
C101-0390-PH	2-1/8	2	1

FEMALE ADAPTOR (C X FEMALE NPT)



Part code	Size (inches)		Pack QTY
	1	2	
C105-0025-PH	3/8	1/2	50
C105-0050-PH	5/8	1/2	50
C105-0057-PH	5/8	3/4	25
C105-0058-PH	3/8	5/8	50
C105-0059-PH	1/4	5/8	50
C105-0100-PH	7/8	3/4	10
C105-0107-PH	7/8	1/2	10
C105-0150-PH	1-1/8	1	5
C105-0159-PH	1-1/8	3/4	5
C105-0215-PH	1-3/8	1-1/4	5
C105-0295-PH	1-5/8	1-1/2	2
C105-0390-PH	2-1/8	2	1

U-TYPE STRAP



Part code	Size (inches)	Pack QTY
C947-0025-PH	1/2	100
C947-0050-PH	5/8	50
C947-0090-PH	3/4	50
C947-0100-PH	7/8	50
C947-0150-PH	1-1/8	10
C947-0215-PH	1-3/8	10
C947-0295-PH	1-5/8	10
C947-0390-PH	2-1/8	5

EQUAL TEE (CXCXC)



Part code	Size (inches)	Pack QTY
C460-0001-PH	1/4	100
C460-0002-PH	3/8	100
C460-0025-PH	1/2	100
C460-0050-PH	5/8	50
C460-0090-PH	3/4	50
C460-0100-PH	7/8	25
C460-0150-PH	1-1/8	10
C460-0215-PH	1-3/8	10
C460-0295-PH	1-5/8	5
C460-0390-PH	2-1/8	1
C460-0520-PH	2-5/8	1
C460-0650-PH	3-1/8	1
C460-0750-PH	3-5/8	1
C460-0850-PH	4-1/8	1

COPPER FITTINGS



REDUCER TEE (CXC)

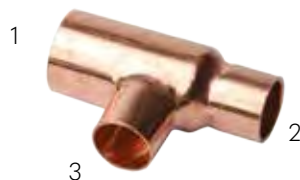

Part code	Size (inches)			Pack QTY
	1	2	3	
C460-0005-PH	3/8	3/8	1/4	100
C460-0006-PH	3/8	3/8	1/2	100
C460-0031-PH	1/2	1/2	5/8	100
C460-0032-PH	1/2	1/2	3/8	100
C460-0033-PH	1/2	1/2	1/4	100
C460-0040-PH	1/2	3/8	1/2	100
C460-0041-PH	1/2	3/8	3/8	100
C460-0056-PH	5/8	5/8	1-1/8	25
C460-0057-PH	5/8	5/8	7/8	25
C460-0058-PH	5/8	5/8	1/2	50
C460-0059-PH	5/8	5/8	3/8	50
C460-0066-PH	5/8	1/2	5/8	50
C460-0067-PH	5/8	1/2	1/2	50
C460-0068-PH	5/8	1/2	3/8	50
C460-0076-PH	5/8	3/8	1/2	50
C460-0087-PH	5/8	5/8	3/4	50
C460-0092-PH	3/4	3/4	7/8	50
C460-0093-PH	3/4	3/4	5/8	50
C460-0094-PH	3/4	3/4	1/2	50
C460-0095-PH	3/4	3/4	3/8	50
C460-0098-PH	3/4	5/8	5/8	50
C460-0106-PH	7/8	7/8	1-1/8	25
C460-0107-PH	7/8	7/8	5/8	25
C460-0108-PH	7/8	7/8	1/2	25
C460-0109-PH	7/8	7/8	3/8	25
C460-0111-PH	7/8	1/2	7/8	25
C460-0117-PH	7/8	5/8	7/8	25
C460-0118-PH	7/8	5/8	5/8	25
C460-0119-PH	7/8	5/8	1/2	25
C460-0127-PH	7/8	1/2	5/8	25
C460-0157-PH	1-1/8	1-1/8	1-5/8	10
C460-0158-PH	1-1/8	1-1/8	1-3/8	10
C460-0159-PH	1-1/8	1-1/8	7/8	10
C460-1498-PH	1-1/8	1-1/8	3/4	10
C460-0160-PH	1-1/8	1-1/8	5/8	10
C460-0161-PH	1-1/8	1-1/8	1/2	10
C460-0169-PH	1-1/8	7/8	1-1/8	10
C460-0170-PH	1-1/8	7/8	7/8	10
C460-0171-PH	1-1/8	7/8	5/8	10
C460-0180-PH	1-1/8	5/8	1-1/8	10
C460-0181-PH	1-1/8	5/8	7/8	10

Part code	Size (inches)			Pack QTY
	1	2	3	
C460-0220-PH	1-3/8	1-3/8	2-1/8	5
C460-0221-PH	1-3/8	1-3/8	1-5/8	10
C460-0222-PH	1-3/8	1-3/8	1-1/8	10
C460-0223-PH	1-3/8	1-3/8	7/8	10
C460-0224-PH	1-3/8	1-3/8	5/8	10
C460-0234-PH	1-3/8	1-1/8	1-3/8	10
C460-0235-PH	1-3/8	1-1/8	1-1/8	10
C460-0237-PH	1-3/8	1-1/8	5/8	10
C460-0245-PH	1-3/8	7/8	1-3/8	10
C460-0246-PH	1-3/8	7/8	1-1/8	10
C460-0247-PH	1-3/8	7/8	7/8	10
C460-0302-PH	1-5/8	1-5/8	2-1/8	5
C460-0303-PH	1-5/8	1-5/8	1-3/8	5
C460-0304-PH	1-5/8	1-5/8	1-1/8	5
C460-0305-PH	1-5/8	1-5/8	7/8	5
C460-0306-PH	1-5/8	1-5/8	5/8	5
C460-0315-PH	1-5/8	1-3/8	1-5/8	5
C460-0316-PH	1-5/8	1-3/8	1-3/8	5
C460-0328-PH	1-5/8	1-1/8	1-5/8	5
C460-0330-PH	1-5/8	1-1/8	1-1/8	5
C460-0331-PH	1-5/8	1-1/8	7/8	5
C460-0339-PH	1-5/8	7/8	1-5/8	5
C460-0397-PH	2-1/8	2-1/8	2-5/8	1
C460-0398-PH	2-1/8	2-1/8	1-5/8	1
C460-0399-PH	2-1/8	2-1/8	1-3/8	1
C460-0400-PH	2-1/8	2-1/8	1-1/8	1
C460-0401-PH	2-1/8	2-1/8	7/8	1
C460-0414-PH	2-1/8	1-5/8	1-5/8	1
C460-0416-PH	2-1/8	1-5/8	1-1/8	1
C460-0417-PH	2-1/8	1-5/8	7/8	1
C460-0429-PH	2-1/8	1-3/8	2-1/8	1
C460-0431-PH	2-1/8	1-3/8	1-3/8	1
C460-0432-PH	2-1/8	1-3/8	1-1/8	1
C460-0531-PH	2-5/8	2-5/8	2-1/8	1
C460-0532-PH	2-5/8	2-5/8	1-5/8	1
C460-0533-PH	2-5/8	2-5/8	1-3/8	1
C460-0534-PH	2-5/8	2-5/8	1-1/8	1
C460-0535-PH	2-5/8	2-5/8	7/8	1
C460-0549-PH	2-5/8	2-1/8	2-1/8	1
C460-0663-PH	3-1/8	3-1/8	2-1/8	1
C460-0664-PH	3-1/8	3-1/8	1-5/8	1



FLEXI SUPPORT SYSTEMS



EVERYDAY

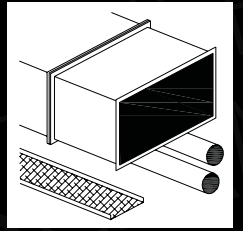

ACCESS

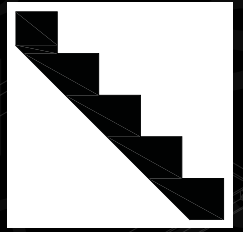

HEAVY

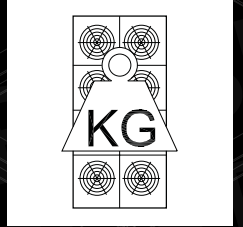

LIGHT

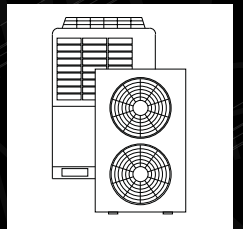

SOLAR

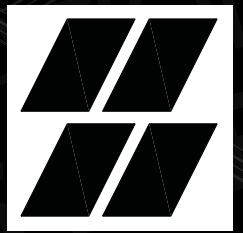

FLEXI RANGE
PAGE 107

sales@flexisupportsystems.com
www.flexisupportsystems.co.uk

SERVICE AND MAINTENANCE



PRO RANGE CONCENTRATED CLEANERS - 5L

Already established as a leading brand of professional coil cleaning and maintenance products, the DiversiTech PRO-RANGE of concentrated coil cleaners are designed to provide outstanding cleaning results combined with minimal environmental impact and maximum economy. Pro Universal is registered as NSF Food Safe, making it ideal to use in and around food processing areas.



Part code	Description	Size	Suitable for use on
PRO-UNIV-GB	"Concentrated - Indoor & Outdoor NSF Registered Food Safe Coil Cleaner"	5 Litre	Condensers / Evaporators / Air Filters
PRO-FOAM+GB	"Concentrated - Heavy Duty Alkaline Based Condensing Coil Cleaner"	5 Litre	Condensers
PRO-CARE-GB	"Concentrated - Evaporator Coil Cleaner with Disinfectant"	5 Litre	Evaporators / Protecting & Disinfectants
PRO-CLEAN-GB	Concentrated - Alkaline Based Evaporator & Condensing Coil Cleaner	5 Litre	Condensers / Evaporators
PRO-COOL-GB	"Concentrated - Non-Odour Liquid Ice Machine Cleaner"	5 Litre	Ice Machines
PRO-SCALE-GB	Concentrated - Lime Scale Remover	5 Litre	Condensers / Exchangers
PRO-GREEN-GB	Concentrated - Environmentally Friendly Indoor and Outdoor Coil Cleaner	5 Litre	Condensers / Evaporators / Air Filers

IS THIS GONE?

G2G RANGE PRE-MIXED CLEANERS - 1L

The DiversiTech G2G-RANGE (Good to Go) are pre-mixed coil cleaners in a 1 litre convenient trigger bottle for quick and easy application.

G2G Universal is registered as NSF Food Safe, making it ideal to use in and around food processing areas.



Part code	Description	Size	Suitable for use on
G2G-UNIV-GB	Pro Universal Pre-Mixed Coil Cleaner	1 Litre	Condensers / Evaporators / Air Filters
G2G-FOAM+GB	Foaming Alkaline Based Pre -Mixed Coil Cleaner	1 Litre	Condensers
G2G-CARE-GB	Liquid Coil Cleaner with Disinfectant	1 Litre	Evaporators / Protecting & Disinfectant
G2G-GREEN+GB	Environmentally Friendly Pre -Mixed Coil Cleaner	1 Litre	Condensers / Evaporators / Air Filter
G2G-BUBBLE+-GB	Bubble Up Leak Detector Pre-Mixed	1 Litre	Leak Detector

AEROSOLS

These professional aerosols are the perfect blend of high performance and excellent economy. The range has seen improvements in formulation and scent.



Part code	Description	Size	Suitable for use on
AER-D-600	Coil Clean - Universal Coil Cleaner	600ml	Condensers / Evaporators
AER-F-600	Coil Foam - Heavy Duty Condenser Cleaner	600ml	AC & Refrigeration Condenser Coils
AER-I-600	Coil Care - Evaporator Cleaner & Disinfectant	600ml	Evaporators
AER-C-600	Case Clean - Case, Fascia & Glass Cleaner	600ml	Fan Coils, Cassette Units & Boiler Cases
AER-B-500	Leak Seek - Bubble Up Detector Spray	500ml	Leak Detector

ODOUR ELIMINATION

The Smell Buster range is a unique odour elimination product that effectively neutralises bad smells in air conditioning systems. Available in 1 Litre pre-mixed spray bottles, 60g twin pack, 12g ten pack and 225g tray.



Part code	Description	Size	Suitable for use on
SMELL-BUSTER-SMALL	Smell Buster - 12g tables (pack of 10)	12g (pack of 10)	RAC Systems
SMELL-BUSTER	Smell Buster - 60g tables (pack of 2)	60g (pack of 2)	RAC Systems
SMELL-BUSTER-8	Smell Buster - 225g (Tub)	225g (Tub)	RAC Systems
G2G-SMELL-BUSTER	Smell Buster Pre Mixed	1 Litre	RAC Systems

COMPRESSION SPRAYERS

Various hand held and compression sprayers are available for applying coil cleaners to the coils. Designed for a fast and easy application.



Part code	Description	Capacity
1002	Hand Held Sprayer	1.4 Litres
2601	Compression Sprayer - 1 Gallon	3.8 Litres
2602	Compression Sprayer - 2 Gallon	7.4 Litres
2603	Compression Sprayer - 3 Gallon	11.4 Litres

SERVICE AND MAINTENANCE



DIVERSI-FLUSH

Dirty and contaminated system? We have a unique system and line cleaning solution, ideal for dealing with compressor burn outs, R22 retrofits and equipment upgrades and replacements.

Effectively removes all traces of residual oil and contaminants, this easy-to-use kit includes everything needed to quickly and effectively clean the entire system.



Part code	Description	Size	Suitable for use on
PF-KIT-EU	Diversi-Flush HVAC Flushing Kit - includes refill	480ml	Compressor Burnouts, R22 retrofits, upgrades
PF-16-EU	Diversi-Flush Solve nt Refill	480ml	Compressor Burnouts, R22 retrofits, upgrades
PF-ADAPTOR	Line Set Adaptor		Compressor Burnouts, R22 retrofits, upgrades

DRAINGUN

Blocked drain line - no problem with our DrainGun™. This lightweight, portable tool is designed to unblock condensate drain lines and other pipework instantly.

Simply insert a CO² cartridge in to the DrainGun and with a press of the trigger, SWOOSH, 800 psi of food grade CO² blows the blockage out.



Part code	Description	Size
GG-1	Drain Gun Line Cleaner	Single Pack
GGC-6	Drain Gun - Pack of 6, CO ² Cartridges	Pack of 6
GG-1A	Drain Gun - Adaptor Kit - for larger tubes, oil lines and 90 degree angles	3 adaptors
GG-1H	Drain Gun - Hose Assembly	Single Pack

MAP+

Map+ is Propane, Propene and Dimethyl Ether Mixture - a high quality gas for soldering and brazing (for professional use only).

Use only with torches designed for MAP GAS. Never use with standard propane appliances such as lanterns, stoves, torches etc.



Part code	Description	Size
MAP+	MAP+ - Propane, Propene & Dimethyl Ether Mixture	453g

NITROGEN PURGE & BRAZING TOOL

The DP-1 Nitrogen Purge Tool is a quick and easy way to purge copper pipes with nitrogen. Connect and turn the dial, this switches to a very low flow of nitrogen to braze the copper. It has a durable aluminium design so you can just throw it into your tool bag when you are done. Can save nitrogen gas used when brazing and purging.



Part code	Description	QTY	Suitable for use on
DP-1	Nitrogen Purge Tool	1	Purging and controlling the flow of nitrogen through pipework during brazing

UNIVERSAL COPPER SPUN DRIERS

Manufactured with the latest generation molecular sieves and compatible with many refrigerants including R134a, our universal copper spun driers can be used in all hermetic and open compressor refrigeration systems. This includes commercial and domestic refrigerators, freezers and air conditioners up to 2.0 HP. The driers are hermetically sealed with extended ends.



Part code	Outlet	Inlet	Diameter	Length	Desiccant R12	Tonnage	QTY
DX-3	1/4" (6mm)	1/4" (6mm)	3/4" (19mm)	7-11/16" (195mm)	10	1/2 (1.75kW)	1
DX-4	Multiple	1/4" (6mm)	1" (6mm)	9" (228mm)	18	1-1/2 (5kW)	1
DXA-5	1/4" (6mm)	1/4" (6mm)	1" (6mm)	9-1/4" (235mm)	20	1-1/2 (5kW)	1

TELESCOPIC INSPECTION MIRRORS

Fast, accurate visual inspection of hidden areas with an almost limitless number of positions. Double ball joint links swivel mirrors for viewing 360 degrees. Precision engineered links are made from tempered spring steel to withstand the stresses of constant repositioning. Moves freely and holds in the desired position.



Part code	Description	QTY
M-1	Mirror 1-1/4" circular - extends 6-1/4" to 18-1/4"	1
M-1R	Replacement Head for M-1	1
M-2	Mirror 2-1/4" circular - extends 10" to 14"	1
M-2R	Replacement Head for M-2	1
M-3	Mirror 2-1/8" x 3-1/2" rectangular - extends 11-1/4" to 15-1/4"	1
M-3R	Replacement Head for M-3	1
M-4	Mirror 7/8" Circular - extends 6-1/2"	1
M-5	Mirror 1" x 2" Oval - extends 8-1/2"	1

FIN-TOOLS & SUPERCOMB

The Multihead fin-tool conveniently straightens and cleans condenser and evaporator fins. Each nylon head slides into the master handle and tightens in place. Heads are coloured and engraved with the size for fast identification. The metal fin straighteners have heavy duty spring wire bristles. The SuperComb has 6 coloured fins. The fin brush is a plastic handled fin brush to clean condenser and evaporator fins



Part code	Description	Pack QTY
T-1	Handle Only	1
T-100	Kit 1 - Handle with 6 Heads - 8,9,10,11,12,14, FPI	1
T-101	Kit 2 - Handle with 6 Heads - 13,15,16,17,18,20	1
T-8	Head 8 FPI - Orange	Pack of 3
T-9	Head 9 FPI - Yellow	Pack of 3
T-10	Head 10 FPI - Neutral	Pack of 3
T-11	Head 11 FPI - Blue	Pack of 3
T-12	Head 12 FPI - Green	Pack of 3
T-13	Head 13 FPI - Pink	Pack of 3
T-14	Head 14 FPI - Light Green	Pack of 3
T-15	Head 15 FPI - Aqua	Pack of 3
T-16	Head 16 FPI - Brown	Pack of 3
T-20	Head 20 FPI - Purple	Pack of 3
T-21	Head 21& 22 FPI - Rose	Pack of 3



Part code	Description	Pack QTY
T-200	Fin Tool	1
T-300	Fin Tool with Heavy Duty Bicycle Handle	1



Part code	Description	Pack QTY
T-400	Set of 6 T-408, T409, T-410, T411, T417, T418	1
T-408	8 and 10 FPI - Orange	1
T-409	9 and 15 FPI - Yellow	1
T-411	11 and 13 FPI - Blue	1
T-412	12 and 14 FPI - Green	1
T-417	16 and 17 FPI - Lime	1
T-418	18 and 20 PI - Red	1



Part code	Description	Pack QTY
B-26	Fin Brush	12

COMPRESSOR TOTE

Makes light work of a heavy job. Made from a strong powder coated steel. Recommended for use with all compressors up to 5 tons.



Part code	Description	Pack QTY
B-26	Fin Brush	12

CLIGHT - PIVOT™ TORCHES

The Pivot™ range has a 360 degree swivel hook and is magnetic at the base and back. Available in colours Yellow/Black and Camo. All models are supplied with three AA batteries.



Part code	Description	Colour	Lumens	UOM	Master QTY
111114	Pivot - 5 LED Work Light	Yellow/Black	240	Each	Pack of 9
111115	Pivot Mini - 18 LED Front Light / 3 LED Top	Yellow/Black	120	Each	Pack of 12
111117	Pivot Mini - 18 LED Front Light / 3 LED Top	Camo	120	Each	Pack of 12
24-458	Pivot 33 - 28 LED Front Light / 5 LED Top	Yellow/Black	160	Each	Pack of 9
24-460	Pivot 33 - 28 LED Front Light / 5 LED Top	Camo	160	Each	Pack of 9

CLIGHT - CLIPSTRIP™ TORCHES

The Clipstrip™ range is a powerful pocket light with clip, available in colours Yellow/Black and Camo. A waterproof aqua clipstrip is available. All models are supplied with three AAA batteries.



Part code	Description	Colour	Lumens	UOM	Master QTY
111112	Clipstrip - Pocket Light	Yellow / Black	140	Each	Pack of 12
111116	Clipstrip - Pocket Light	Camo	140	Each	Pack of 12
111113	Clipstrip - Aqua Pocket Light	Yellow / Black	180	Each	Individual

TORCHES AND LIGHTS



CLIPLIGHT SEEKER™ TORCHES

The Seeker™ range has a mini and max version. The UV light provides a circular spotlight with wide, focused or strobing capacities.

The mini can fit easily in your pocket and runs from AAA batteries. The max runs from a rechargeable lithium battery.



Part code	Description	Colour	Lumens	UOM	Master QTY
84DCPLUS	Seeker - Mini UV LED Circular Spotlight	Red	UV Light	Each	Individual
87DCPLUS	Seeker - Max UV LED Rechargeable Circular Spotlight	Red	UV Light	Each	Individual

CLIPLIGHT FOCUS & STROBE

The Focus & Strobe light packs a big punch for a small light. The powerful single white LED delivers a constant or stobe beam, which can be focused for intensity.



Part code	Description	Colour	Lumens	UOM	Master QTY
111201	Focus & Strobe	Blue	180	Each	Individual

PURE-BEAM™ ULTRAVIOLET LIGHT

Pure-Beam™ ultraviolet light is designed for HVAC air disinfection and surface irradiation. The 17 watt UV-C lamp is a powerful tool to improve indoor air quality. It can be installed in the HVAC system or ductwork on either the return or supply air side of the furnace or air handler.

Exposure to Pure-Beam™ significantly reduces air contamination caused by fungus, mold, and viruses and can cleanse surfaces

overcome by mold and slime. Includes the UV lamp, a UL listed ceramic base, and mounting bracket.



Part code	Description	Colour	Lumens	UOM	Master QTY
UV-1	Ultraviolet Light with 24 VAC elec. Ballast	Blue	180	Each	Individual

THE PURIFIER - FRESH OZONE MACHINE

The purifier fresh ozone machine incorporates the latest in ozone purification technology to eliminate VOC's, mold, mildew, bacteria and viruses. Ideal for use in homes, offices, hotels, businesses to combat lingering odours.



Part code	Description	Dimensions (H x W x L)	Colour	Voltage	Weight
170AIRP	The Purifier - Fresh Air Ozone Machine	139.7mm x 139.7mm x 343mm	Silver	240V	2.3kg

Part code	Description
170AIRFAN	The Purifier - Replacement Fan
410212	The Purifier - Replacement Bulb
170AIRPCB	The Purifier - Replacement Circuit Board
UVEC-07G	The Purifier - 12V Charger

SUPER SEAL PREMIUM & PLATINUM™ - PRO A/C STOP LEAK

Super Seal Premium and Platinum seals leaks in evaporators, condensers, accumulators as well as o-rings, gaskets, metal lines and rubber hoses. Actively prevents future leaks.

Easily installed in minutes and is compatible with all mobile A/C refrigerants including R12, R134A, and R1234YF. Hose included.



Part code	Description	Capacity	UOM	Master Qty
946KIT	Super Seal Premium - with Pro A/C Stop Leak	1.5oz / 45ml	Each	12
976KIT	Super Seal Platinum - with Dry R & FLASH UV Dye	1.7oz / 51ml	Each	12

RETROCHILL™

Retrochill™ is a fast and effective solution to retrofit from R12 to 134A with conversion additives. 5 simple steps to convert. Once you have removed the R12 from your system, attach the hose, add retrochill, attach the refrigerant label and add the R134a retrofit oil. Hose included.



Part code	Description	Capacity	UOM	Master Qty
946KIT	Super Seal Premium - with Pro A/C Stop Leak	1.5oz / 45ml	Each	12
976KIT	Super Seal Platinum - with Dry R & FLASH UV Dye	1.7oz / 51ml	Each	12

SUPER SEAL



SUPER SEAL ADVANCED™ AC/R STOP LEAK & DRY R

Super Seal™ is a 2-in-1 system additive that will find and seal leaks in refrigeration systems. It also contains an eliminator to dry any moisture in the system, preventing waxing and acid formation.

Super Seal is a light, low viscosity particle free liquid that is directly placed into the system as a mist - as it travels with the refrigerant and oil throughout the system, the sealant exits the leak point and reacts with moisture in the air - this forms a low tensile crystalline structure that creates a permanent seal. Super Seal Advanced™ comes with a reusable hose.



Part code	Description	Capacity	UOM	Master Qty
947KIT	Super Seal Advanced - up to 1.5 tons (5kW)	1oz / 30ml	Each	12
944KIT	Super Seal Advanced - 1.5 to 5 tons (5-17kW)	2oz / 59ml	Each	12
948KIT	Super Seal Advanced - 5+ tons (17Kw)	3oz / 89ml	Each	12

SUPER SEAL TOTAL™ AC/R STOP LEAK & DRY R & FLASH

Super Seal Total™ 3-in-1 dries, seals and includes Flash UV dye for a complete repair solution. Super Seal Total is fast and easy to install and requires no pump down or recovery. It's compatible with all oils and refrigerants and ideal for all systems including microchannel, heat pump and geothermal. Super Seal Total™ stops leaks now and prevents future ones too. Super Seal Total™ comes with a reusable hose.



Part code	Description	Capacity	UOM	Master Qty
971KIT	Super Seal Total - up to 1.5 tons (5kW)	1oz / 30ml	Each	12
972KIT	Super Seal Total - 1.5 to 5 tons (5-17kW)	2oz / 59ml	Each	12
948KIT	Super Seal Advanced - 5+ tons (17Kw)	3oz / 89ml	Each	12

SUPER CHANGE™

Super Change™ is the fast and easy way to complete a R22 system retrofit. It creates a strong compatibility link between all oils to any HFC refrigerants, including POE-based R407C & R410A - eliminating compressor downtime and line set flush. It boosts efficiency plus extends compressor life by maximizing heat transfer and oil return with drop-in refrigerants. Ideal for dry charge units, retrofits and drop-in refrigerants. One can treats systems up to 6 tons. The 20122 reusable hose is required - sold separately



Part code	Description	Capacity	UOM	Master Qty
981	Super Change - up to 6 tons	2oz / ml	Each	6

FLASH™

Flash™ UV dye is an advanced class of highly concentrated ultra violet dye that uses DRY R™ instead of POE oil as its carrier. This, combined with our patented misting action, enables the dye to travel at the speed of the refrigerant while keeping the dye stable. One can treats up to 64 oz (1.8L) of oil. Flash UV dye uses the systems refrigerant as the propellant, creating a clean, no-mess injection every time. The 20122 reusable hose is required - sold separately.



Part code	Description	Capacity	UOM	Master Qty
980	Flash - up to 5 tons (17kW)	0.14oz / 4ml	Each	12

FLASH™ UV DETECTION KITS

Two kits are available which include 3 cans of the Flash™ UV dye, reusable clear hose, heavy duty storage case and a choice of UV torch light.



Code	Description	UOM
98084KIT	Flash Kit - 3 cans of Flash - Hose - with SEEKER Mini	1
98087KIT	Flash Kit - 3 cans of Flash - Hose - with SEEKER Max	1

ACCESSORIES



20122



20128

Code	Description	UOM
20122	Reusable Hose	1
20128	R410a & R32 Transitional Fitting 5/16 x 1/4	1

SUPER SEAL



SURE SHOT

Sure Shot™ Sealant Advanced with Eco Boost is a compressor-friendly method of permanently sealing leaks in AC/R systems. Eco Boost reduces noise and energy consumption, extends compressor life, plus eliminates 10 drops of water. It also enhances sealant performance, increases drier efficiency, while preventing waxing and acid formation. Sure Shot is added through an easy to inject syringe. One application works for systems up to 6 tons.



Part code	Description	UOM	Master Qty
983KIT	Sure Shot Sealant Advanced HVAC/R Stop leak with hose	Each	12
984	Sure Shot Replacement Cartridge	Each	12
940	Sure Shot 1/4" SAE Reusable Hose	Each	1

FLEX INJECT®

Flex Inject Sealant Advanced is the fastest, most effective proven way to permanently seal and prevent minor air conditioning and refrigeration (AC/R) leaks. With no tools or gauges required, the Flex Inject sealant works by travelling through the system with the oil and refrigerant fixing leaks immediately. Flex Inject works with all compressors, heat pumps, condensers, and other system components and it will not plug up manifold gauges, metering devices, thermostatic expansion valves (TEVs), pistons or cause cap tube blockages. It meets the ASHRAE ARI 700 refrigerant standard and is compatible with any refrigerant including R-410A with

no pump downs or recoveries required. Flex Inject is suitable for use in aluminium and copper coils and is microchannel friendly.



Part code	Description	UOM	Master Qty
985	Flexi Inject Sealant Advanced for systems up to 6 tons	Each	6

OILS & CLEANERS



PAO 68 OIL



PAO 68 OIL & UV DYE



PAO 68 OIL & HYBRID AC COMPRESSOR OIL



DYE CLEANER

AC DYE



900008



900006B



900012B



909008



909006B



909012B

MULTI-PURPOSE DYE

RADIATOR DYE



990008



990006B



990012B

PAG & DYE

511046



511101



ESTER & DYE

511102



Part code	Brand	Description	Size	Type
51105	Ciplight	PAO 68 Oil	500ml (17oz)	Lubricant
51110	Ciplight	PAO 68 Oil	1 Litre (34oz)	Lubricant
51111	Ciplight	PAO 68 Oil & Dye	1 Litre (34oz)	Lubricant & Dye
51112	Ciplight	Hybrid a/c Compressor Oil	236ml (8oz)	Compressor Oil
805CLN	Ciplight	Dye Cleaner	500ml (17oz)	Dye Remover
900008	Ciplight	A/C Dye	236ml (8oz)	A/C Dye
900006B	Ciplight	A/C Dye	30ml (1oz)	A/C Dye
900012B	Ciplight	A/C Dye	7.5ml (0.25oz)	A/C Dye
909008	Ciplight	Multi-Purpose Dye	236ml (8oz)	Multi-Purpose Dye
909006B	Ciplight	Multi-Purpose Dye	30ml (1oz)	Multi-Purpose Dye
909012B	Ciplight	Multi-Purpose Dye	7.5ml (0.25oz)	Multi-Purpose Dye
990008	Ciplight	Radiator Dye	236ml (8oz)	Radiator Dye
990006B	Ciplight	Radiator Dye	30ml (1oz)	Radiator Dye
990012B	Ciplight	Radiator Dye	7.5ml (0.25oz)	Radiator Dye
511046	Ciplight	Pag & Dye (46 Viscosity)	236ml (8oz)	Pag & Dye
911101	Ciplight	Pag & Dye (100 Viscosity)	236ml (8oz)	Pag & Dye
511150	Ciplight	Pag & Dye (150 Viscosity)	236ml (8oz)	Pag & Dye
511102	Ciplight	Ester & Dye (100 Viscosity)	236ml (8oz)	Ester & Dye

ACCESSORIES



PRO BUBBLE LEAK DETECTOR SPRAY

Pro Bubble is an easy to use leak detector spray, ideal for locating gas and air leaks in pipes and equipment. It will not attack or react with metal surfaces and is highly efficient for the detection of ammonia, refrigerant gas and air leaks at below freezing temperatures.



Part code	Description	UOM	Master Qty
PRO-BUBBLE-32	Pro-Bubble Leak Detector Spray - 32oz with spray top	Each	12

COOL-WELD™ HEAT BARRIER SPRAY

Cool-Weld™ is a spray on gel heat shield for soldering, sweating and welding. Ideal for use on filter driers, pipes, valves, sheet metals, etc. Can be used on porous surfaces such as fabrics or drywall. As long as there is some Cool-Weld™ present the surface will resist charring.



Part code	Description	UOM	Master Qty
COOLWELD-32	Cool-Weld Heat Barrier Spray - 32oz with spray top	Each	12

PULL A SPOUT OILER

All purpose oiler with a 35cm telescoping spout. Zooms out for long shots, and in for short shots, even zooms around corners. Squeeze bottle action. Perfect lubricant for general industrial use. Contains four ounces of finest quality carbon free, rust and oxidation inhibited lubricating oil. Plastic container won't short out around electrical connections. No leakage.



Part code	Description	UOM	Master Qty
CO-1	Pull a spout oiler - 4oz (118ml) with telescoping spout	Each	12

3-IN-ONE MULTI-PURPOSE OIL

This 3-in-one oil lubricates, cleans and prevents rust.



Part code	Description	UOM	Master Qty
3in1	3 in 1 multipurpose oil		100ml

WYPALL CLOTHS

Heavy duty towels that absorb grease, oil, water and solvents from floors, hands, parts, tools and machinery.



Part code	Description	UOM	Master Qty
5-05790	WypAll Plus Towels - White	Each	Box of 9

EXPANDING FOAM SEALANT

A one component closed-cell expanding polyurethane foam sealant that is tack free in 20 minutes. Can be painted to prevent UV damage after 12 hours of drying time. Used to seal around doors, windows, pipes, ducts and vents - in fact, virtually anywhere.



Part code	Description	UOM	Master Qty
01714	Foam Sealant - 355ml	Each	12
01724	Foam Sealant - 591ml	Each	12

SILICONE SEALANTS

Available in clear or white, DiversiTech silicone sealants are 100% food grade and can be used in applications for continuous use up to 232°C. It is UV and water resistant and has long term flexibility.



Part code	Description	UOM	Master Qty
7-4000	Clear Silicone Sealant - 305ml	Each	12
7-4100	White Silicone Sealant - 305ml	Each	12

DIVERSI-GUM SEALING COMPOUND

Diversi-Gum is a non-hardening, non-corrosive sealing compound that is immediately paintable and has a temperature usage range between -4°C and 49°C. It is ideal for sealing openings through foundations or refrigeration pipe entries.



Part code	Description	UOM	Master Qty
6-202-1	Diversi-Gum Sealing compound 450g slug	Each	24
6-202-2	Diversi-Gum Sealing compound 900g slug	Each	20

PRO-TITE™ RESIN BASED THREAD SEALANT

A resin-based thread sealant that adheres to internal surfaces and fills voids while forming a fluid tight seal. Sealing from full vacuum up to 10,000 psi, Pro-Tite is specially formulated for use on metals and plastics subject to extreme vibration. Having a temperature range between -73°C to 204°C, Pro-Tite is impervious to most chemicals, including refrigerants, petroleum products, gases, steam etc.



Part code	Description	UOM	Master Qty
CLL-1	Pro Tite Squeeze Tube - 39ml	Each	12

ACCESSORIES



ACID TEST KITS

Detects acid in refrigeration oil. Convenient one step test means no chemicals are needed. Easy to evaluate, the colour change indicates acidity, the intensity of the colour indicates the amount of acid that is present in the oil sample.



Part code	Description	UOM	Master Qty
ATK-4	Acid Test Kit - Pack of 4 for AB and Mineral oil	Each	4
ATK-1	Acid Test Kit - Pack of 4 for AB and Mineral oil	Each	1
ATK-1P	Acid Test Kit - with POE Oil	Each	1

ACID ELIMINATOR

Keeps acid away; compatible with all refrigerants and oils. Chemically neutralises and prevents acids that are formed in air conditioning and refrigeration systems due to refrigerant and refrigeration oil break-down, moisture, and compressor burnout. Easy-to-use, no complicated charts. Works fast, circulates quickly, and leaves no solids or solid residual. Will not harm system components. Can prevent system breakdown.



Part code	Description	UOM	Master Qty
ACID-ELIM	Acid Eliminator - 115ml	Each	12

DRY R

Dry R eliminates moisture and increases system efficiency. It also dissolves blockages and frees up TEVs - preventing acid and waxing formation. Dry R is compatible with all oils and refrigerants and one can treats systems up to 5 tons.



Part code	Description	Capacity	UOM	Master Qty
973KIT	Dry R Moisture Eliminator - up to 5 tons (17kW)	1oz / 30ml	Each	12

FLOW-PLUS & PRO-TREAT CONDENSATE PAN TREATMENT

A range of Drain Pan treatments to help prevent blockages resulting in condensate overflow. Simply place the tablets in the drain pan, where they will slowly dissolve in the condensate to give a prolonged cleaning action on the sludge. One or two tablets are recommended in each pan per month.



Part code	Description	Equipment tonnage	UOM	Master Qty
FLOW-PLUS-25	Flow Plus Condensate Drain Pan Tablets - 25 Tablets per Jar	1/2 to 3 tons	Each	12
FLOW-PLUS-6	Flow Plus Condensate Drain Pan Tablets - 6 x 1oz blocks	3 to 5 tons	Each	12
PRO-TREAT 151	Pro-Treat 151 Premium Drain Pan Tablets - 100 Tablets per Jar	1 tablet per 3 tons	Each	12

LINE PIERCING VALVES AND TOOLS



QUICK TAP

Features a valve core in the 1/4in. male port. Simply pierce the line and back seat the needle. Flow starts when depressor type charging hose is connected.

Part code	Description	UOM	Master Qty
QT-1	Quick Tap - 1/4", 5/16", 3/8" OD (6.4mm, 8mm, 9mm)	Each	1
QT-2	Quick Tap - 1/2", 5/8" OD (13mm, 16mm)	Each	1



QUICK TAP-2

Identical to the quick tap except that a nylon handle replaces the hex wrench, Phillips-head screws are used

Part code	Description	UOM	Master Qty
QTH-1	Quick Tap 2 - 1/4", 5/16", 3/8" OD (6.4mm, 8mm, 9mm)	Each	1
QTH-2	Quick Tap 2 - 1/2", 5/8" OD (13mm, 16mm)	Each	1



MAC - THE ULTIMATE IN LINE PIERCING VALVES

Install valve, connect charging hose, then service. That's all there is to it with a MAC line piercing valve. MAC valves feature a uniport single connection for piercing and servicing. Sealed with refrigerant resistant 'O' rings, the needle automatically back seats after servicing to leave the line free of restriction.

Part code	Description	UOM	Master Qty
QTM-1	Line Piercing Valve - 1/4", 5/16", 3/8" OD (6.4mm, 8mm, 9mm)	Each	1
QTM-2	Line Piercing Valve - 1/2", 5/8" OD (13mm, 16mm)	Each	1



REFRIGERANT RECOVERY TOOL

Smart features that save refrigerant and time. Our Refrigerant Recovery Pliers make evacuating equipment quick and easy. The pliers have a valve on one end with a sharp needle point and a gasket to keep all recovered refrigerant in the system and prevent leaks.



Part code	Description	Sizes	Weight
1937677	RRP	1/4" to 1-1/8"	13 oz

LINE PIERCING VALVES AND TOOLS



PRO-FIT QUICK CONNECT

The PRO-Fit push-to-connect refrigerant fittings are quick and easy to push in with no flaring or brazing needed. They have a robust brass body with leak-proof double o-ring sealing.

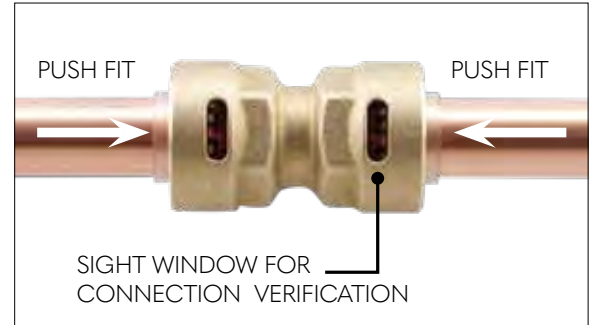

APPROVED FOR HYDROCARBON REFRIGERANTS

Part code	Description
PF-87018	PRO-Fit 1/4" Quick Connect Union
PF-87019	PRO-Fit 3/8" Quick Connect Union
PF-87020	PRO-Fit 1/2" Quick Connect Union
PF-87021	PRO-Fit 5/8" Quick Connect Union
PF-87022	PRO-Fit QUICK 3/4" Quick Connect Union
PF-87023	PRO-Fit QUICK 7/8" Quick Connect Union
PF-87024	PRO-Fit 1/4" Quick Connect 90 Elbow
PF-87025	PRO-Fit 3/8" Quick Connect 90 Elbow
PF-87026	PRO-Fit 1/2" Quick Connect 90 Elbow
PF-87030	PRO-Fit 1/4" - 3/8" Reducer
PF-87031	PRO-Fit 3/8" - 1/2" Reducer
PF-87032	PRO-Fit 1/2" - 5/8" Reducer
PF-87036	PRO-Fit 1/4" Quick Connect Socket
PF-87037	PRO-Fit 3/8" Quick Connect Socket
PF-87038	PRO-Fit 1/2" Quick Connect Socket
PF-87042	PRO-Fit 1/4" Quick Connect Valve
PF-87043	PRO-Fit 3/8" Quick Connect Valve
PF-87044	PRO-Fit 1/2" Quick Connect Valve
PF-87048	PRO-Fit 1/4" - 5/8" Support Kit
PF-87049	PRO-Fit 3/4" - 7/8" Support Kit

SCREWDRIVERS



8" KEYSTONE TIP
SCREWDRIVER 3/8"
1891286

6" CABINET TIP
SCREWDRIVER 1/4"
1891289

KEYSTONE TIP
& CABINET TIP
SCREWDRIVERS

Driven to perform. Everything about these screwdrivers says get work done. They're designed to last with a heattreated, chrome-plated shaft, yet they wouldn't dare strip out your screws.



MORE TORQUE

A SLIP-RESISTANT GRIP ALLOWS FOR MAXIMUM LEVERAGE.



QUICK IDENTIFICATION

EASY-TO-READ TIP MARKINGS ON THE HANDLE MAKE IDENTIFICATION QUICK AND EASY.



RUGGED AND DURABLE

DESIGNED TO LAST WITH A HEATTREATED, CHROME-PLATED SHAFT.

KEYSTONE TIP SCREWDRIVERS

Part code	Description	Shaft length	Tip type / size	Length	Width	Height	Weight
1891355	SDSLKTRS14112	1-1/2"	1/4"	3-1/2"	1-1/4"	1-1/4"	2 oz
1891352	SDSLKTSS144	4"	1/4"	8-1/8"	1"	1"	4 oz
1891356	SDSLKTRS144	4"	1/4"	8"	1-1/8"	1-1/8"	4 oz
1891358	SDSLKTRS5166	6"	5/16"	10-1/2"	1-1/4"	1-1/4"	6 oz
1891286	SDSLKTRS388	8"	3/8"	12-1/2"	1-3/8"	1-3/8"	8 oz

CABINET TIP SCREWDRIVERS

Part code	Description	Shaft length	Tip type / size	Length	Width
1891287	SDSLCTRS3163	3"	3/16"	6-1/2"	1"
1891288	SDSLCTRS3166	6"	3/16"	9-1/2"	1"
1891289	SDSLCTRS146	6"	1/4"	10-1/4"	1"

FIND ME ON PAGE 33

ACCESSORIES



LINE TAP AND SWIVEL VALVES

The quick, safe and easy option to charge, discharge and test a line. Simply clamp on the DLT valve, attach the DLV-1G control valve and pierce the line. The valve can swivel to any position and can also be removed and re-used. Available in three sizes from 4.8mm OD tube to 9.5mm



Part code	Description	UOM	Master Qty
DLT-3G	Line Tap Valve - 4.75mm OD Tube	1	1
DLT-4G	Line Tap Valve - 6.35mm OD Tube	1	1
DLT-5G	Line Tap Valve - 8mm OD Tube	1	1
DCV-1G	Valve for DLT Line Taps	1	1

CORE STORER

All steel valve core remover and storage container. Completely knurled for easier grip, eliminating slippage when using with oily or greasy hands. Core Storer features a compartment for storing extra valve cores. Four replacement cores are included with each tool.



Part code	Description	UOM	Master Qty
VCR-1	Core Removal and Storer	1	1

CORE REMOVAL TOOL

Designed to remove and replace valve cores without losing the refrigerant charge. Connects to any 1/4in. male flare fitting. Saves time, saves refrigerant.



Part code	Description	UOM	Master Qty
VCRT-1	Core Removal Tool	1	1
VCRT-1R	Replacement Rod Assembly	1	1
VCRT-1S	Replacement Shut -Off Stem	1	1

RC-1 INSTA-CHARGE

Faster, safer and a more economical method for charging LIQUID refrigerant through the low pressure side of an air conditioning or refrigeration system, without damaging the compressor. Insta-Charge's unique internal restrictor reduces liquid flow to a level below the capacity of the compressor.

Converts liquid refrigerant to a saturated vapour for fast entry. Insta-Charge connects directly to the refrigerant can or cylinder valve. Adds liquid tracing dye faster. Eliminates heating of refrigerant cylinder. Made of light weight aluminium. Sold at a fraction of the cost of other fast charging devices.



Part code	Description	UOM	Master Qty
RC-1	Insta-Charge	1	1

TAPE

CORK & FOAM INSULATION TAPE

Cork insulation tape adheres firmly to all metals, the foam Insulation tape is a superior self-adhesive foam tape both of which can be used on hot or cold pipes to prevent heat loss and condensation dips. Easily cut and moulded, it fits well around valves and fittings.



ALUMINIUM FOIL TAPE

An easy to handle aluminium tape that prevents heating and cooling losses and blocks odours and moisture. Has a 3-5 year shelf life and a working temperature range of -37°C to 127°C (-35°F to 260°F)



Part code	Description	UOM	Master Qty
6-330	Cork Insulation Tape - Black 1/8" x 2" x 30ft Roll	1	1
6-9718	Foam Insulation Tape - Black 1/8" x 2" x 30ft Roll	1	1
640-AF-2	Aluminium Foil Tape - 2" x 50 yards Roll	1	1

ABRASIVE CLOTH

A high quality aluminium oxide 120 grit abrasive cloth, that can be used wet or dry to thoroughly clean steel and copper tubing.



Part code	Description	UOM	Master Qty
SC-10	Abrasive Cloth - 120 Grit - 1-1/2" x 10 yards	1	1

GRIP-CUT CLOTH

A 180 grit open mesh sand screen cloth with aluminium oxide bonding, that is 100% waterproof. Can be used by hand or with portable tools and is most effective where clogging would be a problem such as soft materials.



Part code	Description	UOM	Master Qty
SCM-5	Grip- Cut Open Mesh Sand Screen Cloth - 1-1/2" x 5 yards	1	1

BRAZE BARRIER MATS

This flame barrier drop cloth withstands temperatures to (1600°C) 3000°F No asbestos. Protects walls, floors, equipment, components and adjacent surfaces from torch flames when soldering, brazing or welding.

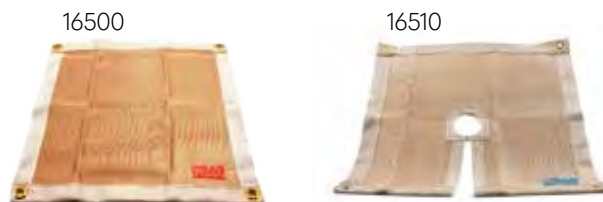

Part code	Description	UOM	Master Qty
16500	Plain Braze Barrier Mat 18" x 18"	1	1
16510	Keyhole Braze Barrier Mat - 18" x 18"	1	1

ACCESSORIES



PORTABLE HAND TORCH

The combustion tip concentrates heat - reducing brazing time by 40%. This series has been redesigned with a patent pending ceramic igniting 1 piece stainless tip feature as well as a new diaphragm type regulator. Extremely durable with a full 3-year warranty.



Part code	Description	UOM	Master Qty
525-TORCH	Portable Hand Torch	Each	1

SPARK KEY™

The Spark Key™ ignites all butane, propane and gas torches. 100,000 sure-fire sparks in a water resistant unit. No batteries are required.



Part code	Description	UOM	Master Qty
SPARK KEY	Spark-Key Torch Ignitor	Each	1

FLEXI PATCH™

Flexi-Patch™ is an easy to use flexible repair patch ideal for repairing almost any surface. It cures quickly using only UV light from sunlight or a UV flashlight for a long lasting, permanent repair.

Flexi-Patch is a fibreglass-reinforced polyester ideal for use on PVC, plastics, metal, wood, concrete and more. It's the easy way to permanently patch almost any surface. It dries hard for permanent repair. Can be drilled and painted once dry.



Part code	Description	UOM	Master Qty
FP-36	Flexi Patch Fibreglass repair patch - 75mm x 150mm - 10 per pack	Each	20

OTHER PUMPS



INDUSTRIAL PUMPS



PARTS WASHER PUMP 1Y-PW (501027) PE2-YSA (14940101)

Submersible, unpainted, aluminium housing pumps with Viton® seals, 1/4" MNPT discharge, master builders conduit fitting. The PE pumps have an epoxy encapsulated motor.



1Y-PW



PE2-YSA

Part code	Brand	Description	Max Head	Max Flow	Dimensions mm (HxWxD)	Discharge Size (inch)	Weight
1Y-PW	Little Giant	Parts Washer Pump	2m	800LPH	117x109x104	1/4" MNPT	1.6kg

Part code	Brand	Description	Max Head	Max Flow	Dimensions mm (HxWxD)	Discharge Size (inch)	Weight
PE2-YSA	Little Giant	Small Submersible Pump	3.8m	1135LPH	142x137x73	1/4" MNPT	2kg

POOL COVER PUMPS

POOL COVER PUMP - APCP-1700 (577309)

Little Giant Pool Cover Pumps help safeguard and protect the pool cover from prolonged accumulation of rain or melting snow. This automatic version is certified for use

on pool covers, all of which can attach to a standard garden hose for easy water removal. It removes standing water from pool covers and is ideal for household water transfer applications.



Part code	Brand	Description	Max Head	Max Flow	Dimensions mm (HxWxD)	Discharge Size (inch)	Weight
APCP-1700	Little Giant	Automatic Pool Cover Pump	6.6m	6814LPH	210x305x305	1" FNPT	5.4kg

WHAT IS 1-ABS?



MAGNETIC DRIVE PUMPS - MD-SC/ MD-HC SERIES

Little Giant magnet driven pumps feature a leak proof design that allows the pumps to be used in a variety of applications where continuous and reliable operation is desired and when pumping corrosive liquid is necessary.

The MD-SC Series is designed to pump mild to strong acids found in electroplating applications with temperatures up to 66°C. The MD-HC series can pump strong acids and alkaline solutions, including sulphuric nitric and hydrochloric acid with temperatures up to 93°C. In addition, the HC series offers "Run Dry" protection.



TE-3-MD-SC



TE-3-MD-HC



TE-4-MD-SC



TE-4-MD-HC



TE-5-MD-SC



TE-5-MD-HC



TE-5.5-MD-SC



TE-5.5-MD-HC



TE-6-MD-SC



TE-6-MD-HC



TE-7-MD-SC



TE-7-MD-HC

Part code	Brand	Description	Max Head	Max Flow	Liquid temp in °C	Inlet Size (inch)	Discharge size (inch)
TE3-MD-SC	Little Giant	Magnetic Drive TE3 Series Pump	3.5m	1980LPH	66°C	1" FNPT	1/2" MNPT
TE3-MD-HC	Little Giant	Magnetic Drive TE3 Series Pump	3.5m	1980LPH	93.3°C	1" FNPT	1/2" MNPT
TE4-MD-SC	Little Giant	Magnetic Drive TE4 Series Pump	4.9m	2940LPH	66°C	1" FNPT	1/2" MNPT
TE4-MD-HC	Little Giant	Magnetic Drive TE4 Series Pump	4.9m	2940LPH	93.3°C	1" FNPT	1/2" MNPT
TE5-MD-SC	Little Giant	Magnetic Drive TE5 Series Pump	6.2m	3660LPH	66°C	1" FNPT	1/2" MNPT
TE5-MD-HC	Little Giant	Magnetic Drive TE5 Series Pump	6.2m	3660LPH	93.3°C	1" FNPT	1/2" MNPT
TE5.5-MD-SC	Little Giant	Magnetic Drive TE5.5 Series Pump	8.8m	6120LPH	66°C	1" FNPT	3/4" MNPT
TE5.5-MD-HC	Little Giant	Magnetic Drive TE5.5 Series Pump	8.8m	6120LPH	82.2°C	1" FNPT	3/4" MNPT
TE6-MD-SC	Little Giant	Magnetic Drive TE6 Series Pump	10.7m	7500LPH	66°C	1" FNPT	3/4" MNPT
TE6-MD-HC	Little Giant	Magnetic Drive TE6 Series Pump	10.7m	7500LPH	82.2°C	1" FNPT	3/4" MNPT
TE7-MD-SC	Little Giant	Magnetic Drive TE7 Series Pump	12.3m	9540LPH	66°C	1-1/2" FNPT	1" MNPT
TE7-MD-HC	Little Giant	Magnetic Drive TE7 Series Pump	12.3m	9540LPH	93.3°C	1-1/2" FNPT	1" MNPT

ISOLATORS

ROTARY ENCLOSED ISOLATORS

Our insulated 3 and 4 pole rotary enclosed isolators are CE marked and suitable for disconnecting the power supply to outdoor air conditioning units.

The isolators are weatherproof to IP65, easy to install and conform to IEC 60947-3. They have a lockable off position and interlocking cover which can be removed only in the off position. Earth and neutral terminals included and M20/25 knockouts up to 63A.



Part code	No of poles	AMPS AC21	AC23 A 240VA	AC23 A 400VA	Cable capacity		Height	Width	Depth
					Solid	Stranded			
IS-3P-20A-S	3	20amp	5.5kW	3.7kW	1-16mm ²	0.75-10mm ²	125mm	100mm	120mm
IS-3P-32A-S	3	32 amp	11kW	7.5kW	1-16mm ²	0.75-10mm ²	125mm	100mm	120mm
IS-3P-20A	3	20amp	5.5kW	3.7kW	1-16mm ²	0.75-10mm ²	175mm	114mm	135mm
IS-3P-32A	3	30amp	11kW	7.5kW	1-16mm ²	0.75-10mm ²	175mm	114mm	135mm
IS-3P-40A	3	40amp	15kW	11kW	1-16mm ²	0.75-10mm ²	175mm	114mm	135mm
IS-3P-63A	3	63amp	22kW	18.5kW	1-16mm ²	0.75-10mm ²	175mm	114mm	135mm
IS-4P-20A-S	4	20amp	5.5kW	3.7kW	1-16mm ²	0.75-10mm ²	125mm	100mm	120mm
IS-4P-32A-S	4	32 amp	11kW	7.5kW	1-16mm ²	0.75-10mm ²	125mm	100mm	120mm
IS-4P-20A	4	20amp	5.5kW	3.7kW	1-16mm ²	0.75-10mm ²	175mm	114mm	135mm
IS-4P-32A	4	32amp	11kW	7.5kW	1-16mm ²	0.75-10mm ²	175mm	114mm	135mm
IS-4P-40A	4	40amp	15kW	11kW	1-16mm ²	0.75-10mm ²	175mm	114mm	135mm
IS-4P-63A	4	63amp	22kW	18.5kW	1-16mm ²	0.75-10mm ²	175mm	114mm	135mm

PROTECTIVE HOUSING

Easy-Fit housings are manufactured in two sizes and are ideal for all brands of outdoor refrigeration condensing equipment.

The steel goes through an 8-phase epoxy polyester powder coating process and is finished with a scratch resistant textured finish in RAL 7032.



Part code	Size	External dimensions mm			Internal dimensions mm			Weight
		H	W	D	H	W	D	
CH-S	Small	500	710	600	410	640	530	23kg
CH-L	Large	550	810	720	460	740	640	30kg

IDENTIFICATION LABELS

Our identification labels are made of vinyl. Each label indicates the type of refrigerant contained in a handy pack of 10. We also supply pipe labels. Labels are provided by properly identifying the type of refrigerant contained in the system and air conditioning and refrigeration equipment. For more information.

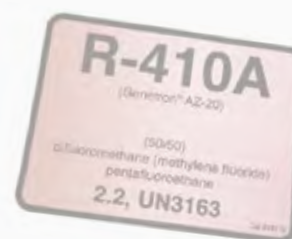

FIND ME ON
PAGE 10

BOILER & HEATING

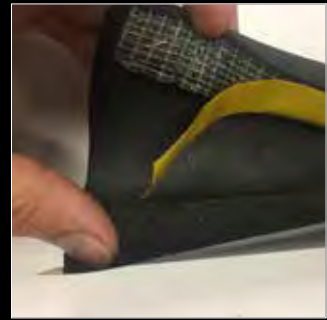

BOILER CONDENSATE PUMPS



TANK PUMPS

DiversiTech stock a range of boiler condensate removal pumps that are ideal when the boiler condensate can not be removed via gravity. The tank pumps use a small bore of flexible hose which can be routed above or below doors, windows or under kitchen cabinets.

When routing hose through any area which could be exposed to freezing temperatures, such as lofts, basements or garages, we strongly recommend increasing to at least 32mm plastic pipe and insulating.



Part code	Brand	Description	Max head	Max flow	Drink cycle	Dimensions mm (HxWxD)	Discharge Size (inch)
PH-0.8LC	Pump House	0.8 Litre Tank Pump with Cover	3m	150LPH	200ml	128x210x86	9.5mm (3/8)
PH-0.8L-HL	Pump House	0.8 Litre Tank Pump	6m	270LPH	300ml	122x220x134	9.5mm (3/8)
PH-20-STA	Pump House	2 Litre Tank Pump	5.5M	402LPH	650ML	166x286x135	9.5mm (3/8)

PRVSURE PRV & CONDENSATE PUMP

This pump is manufactured from high temperature plastic, and comes complete with 10m of higher specification hose.

It meets EN Standards and can handle temperatures up to 110 degrees. Supplied with 10 metres of 'no sag' high grade braided hose. The unique design also cools the PRV discharge so it is safe for use with solvent weld pipework. For installers who are audited or working to EN Standards.

PRVSure



PH-3.8L-HW

Part code	Brand	Description	Max head*	Max flow	Temp	Dimensions mm (HxWxD)	Discharge Size (inch)
PH-3.8L-HW	Pump House	High Temperature & Pressure Relief Pump	8m / 20m	32 LPM (1920LPH)	100°C	350x190x260	15mm

* meeting BS6798:2014 PRV requirements

HIGH TEMPERATURE PRESSURE RELIEF PUMP - PH-5L-HW

Designed for unvented cylinder T&P discharge and steam humidifiers. Having one of the largest discharge rates of 32 litres per minute this pump can handle both high temperature up to 100 degrees and high flow rates.

Manufactured in the UK this heavy duty, high temperature tank pump incorporates thermal overload protection and a high level alarm switch.



PH-5L-HW

IN SITU



Part code	Brand	Description	Max head*	Max flow	Temp	Dimensions mm (HxWxD)	Discharge Size (inch)
PH-5L-HW	Pump House	High Temperature & Pressure Relief Pump	8m / 20m	32 LPM (1920LPH)	100°C	350x190x260	15mm

* Max Heads - 8 metre for flow rates up to 25 Litres per minute / 20 metre for flow rates of 5 Litres per minute

CONDENSATE NEUTRALISERS



COMMERCIAL CONDENSATE NEUTRALISER - 20 & 30 LITRES

Installing a neutraliser will reduce the impact of damage to existing boiler concrete drainage gullies and allow for the condensate to be disposed of safely.

The 20-litre stainless steel version can handle condensate from boilers up to 600kW by gravity.

The 30-litre version comes complete with a pump to provide a 5.9 metre lift and a flow rate of up to 900 litres per hour. Both come with lime chippings for instant installation and are suitable for 2.8pH boiler condensate.



BCONDNEUT-20L*



BCONDNEUT-30L*

Part code	Brand	Description	Tank capacity	Dimensions mm (HxWxD)	Discharge Size (inch)	Inlet	Weight
BCONDNEUT-20L	Pump House	20 Litre with lime chippings	20L	200x400x300	9.5mm (3/8)	40mm	27kg
BCONDNEUT-30L	Pump House	30 Litre with pump & lime chippings	30L	200x550x305	9.5mm (3/8)	40mm	30kg

* Modular & bespoke designs are available for boilers over 600kW.

TO CHECK

SUBMERSIBLE DRAINAGE BASEMENT PUMP

Little Giant have the perfect pump solution for the removal of clean, non-aggressive residual water. This pump can be used to assist with the extraction of flood water in properties with basements and can be used with a sump to provide the removal of water below floor level.



Part code	Brand	Description	Max head	Max flow	Dimensions mm (HxWxD)	Discharge size	Weight
6E-CIA-SFS	Little Giant	Drainage Basement Pump	4.6m	9600LPH	258x269x213	38mm (1/2)	12.7kg

SWIMMING POOL COVER PUMP - APCP-1700

The Little Giant APCP pool cover pump helps safeguard and protect the pool cover from prolonged accumulation of rain or melting snow. This automatic version is certified for use on pool covers, all of which can attach to a standard garden hose for easy water removal.

It removes standing water from pool covers and is ideal for household water transfer applications.

APCP-1700



Part code	Brand	Description	Max head	Max flow	Dimensions mm (HxWxD)	Discharge size	Weight
APCP-1700	Little Giant	Automatic Pool Cover Pump	6.6m	6814LPH	210x305x305	1" FNPT	5.4kg

SOAKAWAY AND CONDENSATE BYPASS VALVE



SOAKAWAY KIT FOR CONDENSING BOILERS

'Soak up' boiler condensate with our soakaway. Where a suitable gravity drain is not available the soakaway can be used in conjunction with 10mm lime chippings.

Compatible with the following pipe sizes: 22mm (3/4") overflow, 32mm (1-1/4") and 40mm (1-1/2").



TOP VIEW



1. DIG HOLE (MIN DEPTH) 400MM X 300MM IN DIAMETER, AT LEAST 500MM FROM THE WALL



2. FILL THE BOTTOM OF THE HOLE WITH 100MM DEPTH OF LIME CHIPPINGS.

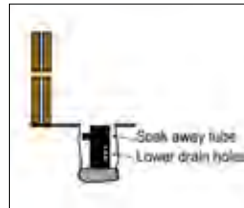

3. INSERT THE SOAKAWAY TUBE WITH THE LOWER DRAIN HOLES FACING AWAY FROM THE PROPERTY.

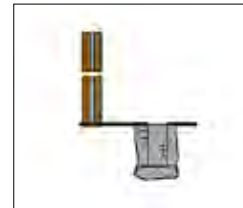

4. FILL THE REMAINING PART OF THE HOLE AND TUBE WITH LIME CHIPPINGS

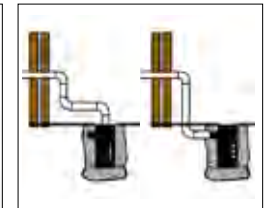

5. FEED THE PIPEWORK EITHER INTO THE TOP OR THROUGH THE SIDE OF THE SOAKAWAY.

Part code	Description	Height	Diameter	Inlet (inch)
SOAK1	Soakaway Kit for Condensing Boilers	300mm	110mm	22mm (3/4) 32mm (1-1/4) 40mm (1-1/2)

FREEZING CONDENSATE SOLUTION BOILER BUOY CONDENSATE BYPASS VALVE

Low cost, easy to install solution to bypass freezing pipes. Cutting a condensate pipe due to freezing has been common place over winter periods. The BB-1 Boiler Buoy condensate bypass valve is a solution that has been designed to be fitted during install, emergency call outs or whilst performing annual service visits.

A red float which when visible, indicates that the condensate pipe has a blockage or may be frozen.

The built in tap allows the householder to drain the condensate away safely and ensures that the heating of the property can continue to work.



Part code	Description	Height	Diameter	Outlet	Hose Length
BB-1	Boiler Buoy - Condensate Bypass Valve	115mm	29mm	9.5mm	1.5m

ACCESSORIES

DiversiTech International stock a range of adaptors,, connectors, clamps, clips and hoses to connect the unit and pump.



Part code	Description	Pump type application	Pack QTY
adap-1	Condensate drain adaptor - 22mm to 9.5mm (7/8 to 3/8")	Tank pump - 9.5mm (3/8") outlet	Single
ph-pump-nrv	Non-return check valve - 9.5mm (3/8")	Tank pump - 9.5mm (3/8") outlet	Single
anti-syph-kit	Anti Syphon Kit - 9.5mm (3/8")	Tank pump - 9.5mm (3/8") outlet	Single
701-038	Hose 'T' connector - Nylon 9.5mm (3/8")	Tank pump - 9.5mm (3/8") outlet	2-pack
701-032	Hose connector - Nylon 9.5mm (3/8")	Tank pump - 9.5mm (3/8") outlet	2-pack
b-6h	Hose clamp - 6.3mm - 9.5mm (1/4 - 3/8")	All pumps	Single
927033	Hose clip - 9.5mm (3/8")	Tank pump - 9.5mm (3/8") outlet	Single
rvt-3/8	Condensate drain hose - 9.5mm (3/8")	Tabnk pump / hot water pumps	30m

SELF-SEALING PIPE ADAPTOR

The self-sealing adaptor is used to form a connection between condensate hose and a soil & vent pipe. Drill a 13mm hole (for SVA-3) or a 10mm hole (for SVA-6), insert and twist in to seal the connection.

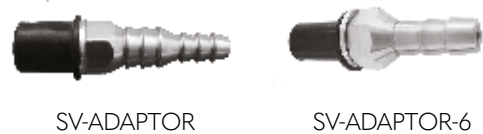

Part code	Description	Pack QTY
SVA-3	Self-sealing pipe adaptor - 6mm & 9.5mm (1/4 & 3/8) hose to soil & vent pipe	3 Pack
SV-ADAPTOR	Self-sealing pipe adaptor - 6mm & 9.5mm (1/4 & 3/8) hose to soil & vent pipe	Single
SVA-6-3	Self-sealing pipe adaptor - 6mm (1/4) hose to soil & vent pipe	3 pack
SV-ADAPTOR-6	Self-sealing pipe adaptor - 6mm (1/4) hose to soil & vent pipe	Single

AUDIBLE ALARM

This audible alarm can be wired into all pumps with a high level switch.



Part code	Description	Pack QTY
audible-alarm	Audible alarm for all pumps with a high-level switch	Single

PORTABLES



PORTABLES - COOL ONLY & HEAT / COOL PUMP

A energy efficiency

The portable air conditioners are suitable for offices, computer rooms and light commercial use. The cooling only model is ideal for cooling flats, conservatories or loft conversions during hot summer months. The heat and cool model can be used as an energy efficient form of heating along with cooling. The units come with a hose, tray, remote control and wall kit. Spare parts are available upon request - please enquire for more details.



PAC-C-12-R290

Part code	Description	Cool capacity Btu/kW	Heat capacity Btu/kW	Watts	Amps	Air flow volume	EER	COP	Sound power level dBA
PAC-C-12-R290	Portable (cooling)	12,000 / 3.5	N/A	1350	5.9	420m ³ /h	2.6	N/A	56
PAC-H-12-R290	Portable (heat pump)	12,000 / 3.5	N/A	1350	5.9	420m ³ /h	2.6	N/A	56

Part code	Description	Height	Width	Depth	Weight	Hose length	Refrigerant	Cooling area
PAC-C-12-R290	Portable (cooling)	730mm	485mm	360mm	28kg	1.5m	R290	25-30m ²
PAC-H-12-R290	Portable (heat pump)	730mm	485mm	360mm	28kg	1.5m	R290	25-30m ²

PRE-SLIT AND SEAL WEATHERPROOF INSULATION

THROUGH WALL INSULATION KIT

Running pipe work from an externally mounted air source heat pump or biomass boiler into a property requires the pipe work to be run through the exterior wall. The hot pipe work will be affected by cold bridging and heat loss if it is not insulated correctly. MIS 3005 requires external pipe work to be adequately insulated. This kit provides both thermal insulation within the wall and comes complete with an elbow section to cover the external copper pipe connection.



1. SELECT A 65MM CORE DRILL.



2. DRILL TWO 65MM HOLES NEXT TO EACH OTHER.



3. INSERT THE PVC SLEEVE INSULATION, RECESS IT TO ALLOW FOR THE ELBOW TO BE LOCATED.



4. FIT THE ELBOW OVER THE COPPER PIPES.

Part code	Description
tw-kit	Sleeved PVC coated insulation kit - 19mm wall thickness (2 x elbow and 2 x straight connectors)

FUSED SPUR SWITCHES

Part code	Description
X-FSBBMC	Fused Spur Metal Clad - with Back Box
X-FSNBBMC	Fused Spur Metal Clad - with Back Box & Neon
X-FS	Fused Spur Plastic - without neon
X-FSN	Fused Spur Plastic - with neon
X-BBSM-25	Back Box Surface Mount - 25mm
X-BBSM-35	Back Box Surface Mount - 35mm
X-BBSM26-25	Back Box 2 Gang - 25mm
X-BBSM2G-35	Back Box 2 Gang - 35mm
X-BSPS-10A	Plug Socket - 10 Amp
X-2GSW2W-10A	Switch 2 Gang - 10 Amp
X-3GSW2W-10A	Switch 3 Gang - 10 Amp
X-1GDPSW-13A	Switch 1 Gang - 13 Amp
X-2GDPSW-13A	Switch 2 Gang - 13 Amp
X-DPSW-20A	Switch Double Pole - 20 Amp
X-PT	Plug Top - 13 Amp



FUSED SPUR METAL



FUSED SPUR PLASTIC

SERVICE AND MAINTENANCE

DRAINGUN

Blocked drain line - no problem with our DrainGun™. This lightweight, portable tool is designed to unblock condensate drain lines and other pipework instantly.

Simply insert a CO² cartridge in to the DrainGun and with a press of the trigger, SWOOSH, 800 psi of food grade CO² blows the blockage out.



Part code	Description	Size
GG-1	Drain Gun Line Cleaner	Single Pack
GGC-6	Drain Gun - Pack of 6, CO ² Cartridges	Pack of 6
GG-1A	Drain Gun - Adaptor Kit - for larger tubes, oil lines and 90 degree angles	3 adaptors
GG-1H	Drain Gun - Hose Assembly	Single Pack

MAP+

Map+ is Propane, Propene and Dimethyl Ether Mixture - a high quality gas for soldering and brazing (for professional use only).

Use only with torches designed for MAP GAS. Never use with standard propane appliances such as lanterns, stoves, torches etc.



Part code	Description	Size
MAP+	MAP+ - Propane, Propene & Dimethyl Ether Mixture	453g

TORCHES



CLIPLIGHT - PIVOT™ TORCHES

The Pivot™ range has a 360 degree swivel hook and is magnetic at the base and back. Available in colours Yellow/Black and Camo. All models are supplied with three AAA batteries.



Part code	Description	Colour	Lumens	UOM	Master QTY
111114	Pivot - 5 LED Work Light	Yellow/Black	240	Each	Pack of 9
111115	Pivot Mini - 18 LED Front Light / 3 LED Top	Yellow/Black	120	Each	Pack of 12
111117	Pivot Mini - 18 LED Front Light / 3 LED Top	Camo	120	Each	Pack of 12
24-458	Pivot 33 - 28 LED Front Light / 5 LED Top	Yellow/Black	160	Each	Pack of 9
24-460	Pivot 33 - 28 LED Front Light / 5 LED Top	Camo	160	Each	Pack of 9

TAPES



ABRASIVE CLOTH

A high quality aluminium oxide 120 grit abrasive cloth, that can be used wet or dry to thoroughly clean steel and copper tubing.



Part code	Description	UOM	Master Qty
SC-10	Abrasive Cloth - 120 Grit - 1-1/2" x 10 yards	1	1

GRIP-CUT CLOTH

A 180 grit open mesh sand screen cloth with aluminium oxide bonding, that is 100% waterproof. Can be used by hand or with portable tools and is most effective where clogging would be a problem such as soft materials.



Part code	Description	UOM	Master Qty
SCM-5	Grip- Cut Open Mesh Sand Screen Cloth - 1-1/2" x 5 yards	1	1

BRAZE BARRIER MATS

This flame barrier drop cloth withstands temperatures to (1600°C) 3000°F No asbestos. Protects walls, floors, equipment, components and adjacent surfaces from torch flames when soldering, brazing or welding.



Part code	Description	UOM	Master Qty
16500	Plain Braze Barrier Mat 18 " x 18"	1	1
16510	Keyhole Braze Barrier Mat - 18" x 18"	1	1

COOL-WELD™ HEAT BARRIER SPRAY

Cool-Weld™ is a spray on gel heat shield for soldering, sweating and welding. Ideal for use on filter driers, pipes, valves, sheet metals, etc. Can be used on porous surfaces such as fabrics or drywall. As long as there is some Cool-Weld™ present the surface will resist charring.



Part code	Description	UOM	Master Qty
COOLWELD-32	Cool-Weld Heat Barrier Spray - 32oz with spray top	Each	12

TELESCOPIC INSPECTION MIRRORS

Fast, accurate visual inspection of hidden areas with an almost limitless number of positions. Double ball joint links swivel mirrors for viewing 360 degrees. Precision engineered links are made from tempered spring steel to withstand the stresses of constant repositioning. Moves freely and holds in the desired position.



Part code	Description	Qty
M-1	Mirror 1-1/4" circular - extends 32mm - 463mm (6-1/4" to 18-1/4")	1
M-2	Mirror 57mm (2-1/4") circular - extends 254mm - 355mm (10" to 14")	1
M-3	Mirror 54mm x 183mm (2-1/8" x 3-1/2") rectangular - extends 285mm - 387mm (11-1/4" to 15-1/4")	1
M-4	Mirror 22mm (7/8") Circular - extends 165mm (6 -1/2")	1
M-5	Mirror 25mm x 50mm (1" x 2") Oval - extends 191mm (8-1/2")	1

WYPALL CLOTHS

Heavy duty towels that absorb grease, oil, water and solvents from floors, hands, parts, tools and machinery.



Part code	Description	UOM	Master Qty
5-05790	WypAll Plus Towels - White	Each	Box of 9

ACCESSORIES



EXPANDING FOAM SEALANT

A one component closed-cell expanding polyurethane foam sealant that is tack free in 20 minutes. Can be painted to prevent UV damage after 12 hours of drying time. Used to seal around doors, windows, pipes, ducts and vents - in fact, virtually anywhere.



Part code	Description	UOM	Master Qty
01714	Foam Sealant - 355ml	Each	12
01724	Foam Sealant - 591ml	Each	12

SILICONE SEALANTS

Available in clear or white, DiversiTech silicone sealants are 100% food grade and can be used in applications for continuous use up to 232°C. It is UV and water resistant and has long term flexibility.



Part code	Description	UOM	Master Qty
01714	Foam Sealant - 355ml	Each	12
01724	Foam Sealant - 591ml	Each	12

DIVERSI-GUM SEALING COMPOUND

Diversi-Gum is a non-hardening, non-corrosive sealing compound that is immediately paintable and has a temperature usage range between -4°C and 49°C. It is ideal for sealing openings through walls from pipe work.



Part code	Description	UOM	Master Qty
6-202-1	Diversi-Gum Sealing compound 450g slug	Each	24
6-202-2	Diversi-Gum Sealing compound 900g slug	Each	20

FLEXI PATCH™

Flexi-Patch™ is an easy to use flexible repair patch ideal for repairing almost any surface. It cures quickly using only UV light from sunlight or a UV flashlight for a long lasting, permanent repair.

Flexi-Patch is a fiberglass-reinforced polyester ideal for use on PVC, plastics, metal, wood, concrete and more. It's the easy way to permanently patch almost any surface. It dries hard for permanent repair. Can be drilled and painted once dry. Capable of handling pressures upto 500psi and temperature range -26°C to 150°C



Part code	Description	UOM	Master Qty
FP-36	Flexi Patch Fibreglass repair patch - 75mm x 150mm - 10 per pack	Each	20

PLASTIC PIPE FITTINGS



Code White	Code Black	Description	Pipe Size (mm)	Quantity
PP-90EL-21.5-W	PP-90EL-21.5-B	Plastic Pipe - 90 Degree Elbow	21.5mm	Pack of 10
PP-45EL-21.5-W	PP-45EL-21.5-B	Plastic Pipe - 45 Degree Elbow	21.5mm	Pack of 10
PP-CON-21.5-W	PP-CON-21.5-B	Plastic Pipe - Straight Connector	21.5mm	Pack of 10
PP-T-21.5-W	PP-T-21.5-B	Plastic Pipe - T Connector	21.5mm	Pack of 10
PP-PIPE-21.5-W	PP-PIPE-21.5-B	Plastic Pipe	21.5mm	3 metre

"Code White"	"Code Black"	"Code Grey"	Description	"Pipe Size (mm)"	Quantity
PP-CL-15-W			Plastic Pipe Clip	15mm	Pack of 100
PP-CL-22-W			Plastic Pipe Clip	22mm	Pack of 100
PP-CL-28-W			Plastic Pipe Clip	28mm	Pack of 100
PP-CL-32-W	PP-CL-32-B	PP-CL-32-G	Plastic Pipe Clip	32mm	Pack of 10
PP-CL-40-W	PP-CL-40-B	PP-CL-40-G	Plastic Pipe Clip	40mm	Pack of 10

Code	Description	Size	Quantity
X-SOLCEM	Solvent Cement	250ml	1

PLASTIC PIPE CLAMPS / NON-RETURN VALVES

Our plastic pipe clamps are designed to connect overflow or waste hose pipe to an existing 32mm (1-1/4") or 40mm (1-1/2") pipe. To avoid waste water flowing back up the pipe work our non-return valves can be used on overflow pipe or waste hose pipe.

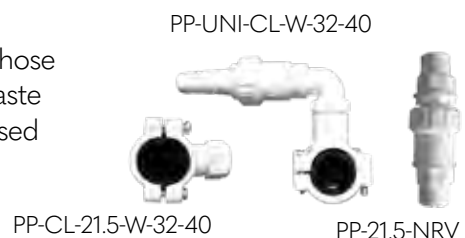

Part code	Description	Quantity
PP-CL-21.5-W-32-40	Pipe Clamp Kit - 21.5mm overflow to 32mm (1-1/4") and 40mm (1-1/2")	1
PP-UNI-CL-W-32-40	Pipe Clamp - Hose Connector 32mm (1-1/4") and 40mm (1-1/2")	1
PP-21.5-NRV	Non-Return Valve - for 21.5mm overflow pipe	1
PP-UNI-NRV	Non-Return Valve - with Hose Fitting	1

PLASTIC PIPE FITTINGS



STRAP ON BOSS

Using a Strap On Boss allows you to add condensate drain pipe to a soil and vent pipe. For adding a waste connection into an existing PVCu and cast iron soil pipe. For use with 32mm or 40mm pipes. Must be solvent welded into position.



Part code	Description	Colour	Quantity
PP-SOBOSS-110-G-32	Strap On Boss - 110mm Pipe with 32mm (1-1/4") Rubber	GREY	1
PP-SOBOSS-110-G-40	Strap On Boss - 110mm Pipe with 40mm (1-1/2") Rubber	GREY	1
PP-SOBOSS-110-B-32	Strap On Boss - 110mm Pipe with 32mm (1-1/4") Rubber	BLACK	1
PP-SOBOSS-110-B-40	Strap On Boss - 110mm Pipe with 40mm (1-1/2") Rubber	BLACK	1
X-PVCU-SOBSC-110MM	Strap On Boss - 110mm PVCU		10

PVC PIPES

PVC-U - ELBOW 3/4" 90 DEGREE



PVC-U - 3/4" SOCKET



PVC-U - 3/4" T PIECE



PVC-U - 3/4" MACLOW CLIPS



Part code 3/4"	Part code 1"	Part code 1-1/4"	Description	Quantity
X-PVCU-3/4E-45		X-PVCU-1-1/4E-45	PVCU - Elbow - 45 Degree	10
X-PVCU-3/4-45T		X-PVCU-1-1/4-45T	PVCU - 45 Degree T	10
X-PVCU-3/4E-90	X-PVCU-1E-90	X-PVCU-1-1/4E-90	PVCU - Elbow - 90 Degree	10
X-PVCU-3/4-MAC	X-PVCU-1-MAC	X-PVCU-1-1/4-MAC	PVCU - MacLow Clips	10
X-PVCU-3/4-EC			PVCU - End Cap	10
X-PVCU-3/4P-3M	X-PVCU-1P-3M	X-PVCU-1-1/4-3M	PVCU - Pipe - 3 Metre Length	10
X-PVCU-3/4-SOC	X-PVCU-1-SOC	X-PVCU-1-1/4-SOC	PVCU - Socket	10
X-PVCU-3/4-CAP		X-PVCU-1-1/4-CAP	PVCU - Threaded Cap	10
X-PVCU-3/4-PIN		X-PVCU-1-1/4-PIN	PVCU - Pin / Barrel	10
X-PVCU-3/4-R		X-PVCU-1-1/4-R	PVCU - Reducer	10
X-PVCU-3/4-RE		X-PVCU-1-1/4-RE	PVCU - Rodding Eye	10
X-PVCU-3/4-TP	X-PVCU-1TP	X-PVCU-1-1/4-TP	PVCU - T Piece	10

AIR SOURCE HEAT PUMPS INSTALLATION PRODUCTS



INSTALLING



WALL MOUNTING BRACKETS

Our Type-2 brackets come with a cross-bar to allow for correct spacing of the arms. An integral spirit level allows for easier installation. All brackets go through a 4-stage ant-corrosion process. *



IVORY (RAL 7032)

Part code	Description	Safe working load*	Max load	Crossbar	Upright	Support arm	Weight
CBR2-S	Type 2 Bracket - Small	60kg	120kg	720mm	400mm	400mm	3.8kg
CBR2-M	Type 2 Bracket - Medium	90kg	180kg	900mm	500mm	500mm	4.6kg
CBR2-L	Type 2 Bracket - Large	140kg	280kg	1040mm	550mm	540mm	6.6kg
CBR2-XL	Type 2 Bracket - XL	250kg	500kg	1040mm	550mm	660mm	16.2kg
CBR2-XXL	Type 2 Bracket - Double XL	200kg	400kg	1040mm	550mm	780mm	17.3kg

BLACK

Part code	Description	Safe working load*	Max load	Crossbar	Upright	Support arm	Weight
CBR2-XL-BL	Type 2 Bracket - XL	250kg	500kg	1040mm	550mm	660mm	16.2kg
CBR2-XL-3A-BL	Type 2 Bracket - XL (3 arms)	250kg	500kg	1040mm	550mm	660mm	16.2kg
CBR2-XXL-BL	Type 2 Bracket - XL	200kg	400kg	1040mm	550mm	780mm	16.5kg
CBR2-XXL-3A-BL-DA	Type 2 Bracket - Double XL (3 arms)	200kg	400kg	1120mm	550mm	780mm	17.3kg

* All brackets are tested to 2 x safe working load.

NB: Sea salts are very corrosive and affect both ferrous and non-ferrous metals. Coastal installations are particularly at risk as they are frequently exposed to sea salt solutions followed by dry periods, where this wet/dry cycle produces a very corrosive environment. We strongly recommend that in such locations only our stainless steel brackets are installed.

EASY-FIT CONDENSATE TRAYS

Concave profile to ensure efficient drainage. Supplied with fixing arms to mount to bracket. All trays go through a 4-stage ant-corrosion process. All trays are 25mm high.



Part code	Description	Depth	Width	Weight
CCTM-800	Metal tray - small	400mm	800mm	5.23kg
CCTM-1080	Metal tray - 1080mm	500mm	1080mm	7.5kg
CCTM-1100	Metal tray - medium	400mm	1100mm	6.9kg
CCTM-1300	Metal tray - 1300mm	550mm	1300mm	8.8kg
CCTM-1400	Metal tray - large	400mm	1400mm	8.3kg

Part code	Description	Width	Length	Weight
CCTM01420-BL	Metal tray	500mm	1420mm	8.5kg

FLEXI LITE SLAB AND FOOT KIT



A low cost innovative solution for floor mounting heat pumps. The FLEXI Lite Slab and Foot kits avoid the high cost and time consuming need to construct a concrete base. Each kit comes complete with FLEXI rubber mounting feet, an Ultralite slab, and all the fixings. It can be delivered to site with minimum preparation and can be assembled in minutes.

The Ultralite slab is a heavy duty slab with a polystyrene core and a fibre reinforced concrete coating. This makes the slab a fraction of the weight of a traditional concrete slab.



Part code	Description	Specifications (WxDxH)
FF-UC3-S	Flexi Lite Kit - small	900 x 600 x 175
FF-UC3-M	Flexi Lite Kit - medium	1050 x 600 x 175
FF-UC3	Flexi-Lite Slab Kit	1200 x 600 x 175
FF-UC3-3	Flexi lite Slab Kit - 3 FEET	1200 x 600 x 175
FF-UC3-XL	Flexi-Lite Slab Kit - extra large	1650 x 865 x 175
FF-UC3-3XL	Flexi-Lite Slab Kit - 3 FEET - extra large	1525 x 915 x 75
FF-UC3-3XL-150	Flexi-Lite Slab Kit - 3 FEET (150mm feet) - extra large	1650 x 865 x 225

INSTALLING



FLEXI FOOT - SINGLE

Flexi Foot with 41mm galvanised Steel channel.



Part code	Size L x W x H mm	Weight	Safe working load
FF-250-S-P	250x185x100	2.8kg	175kg
FF-400-S-P	400x185x100	4.6kg	280kg
FF-600-S-P	600x185x100	7.6kg	420kg
FF-600-S-150	600x185x150	7.6kg	420kg
FF-1000-S-P	1000x185x100	12kg	700kg

FLEXI FOOT KITS

2 x Flexi feet with fixings pack.



Part code	Description
FF-400-S-KIT	flexi-FOOT Kit - 400 (2 x 400mm feet + fixing kit)
FF-600-S-KIT	Flexi-FOOT Kit - 600 (2 x 600mm feet + fixing kit)
FF-600-S-KIT-3	Flexi-FOOT Kit - 600 (3 x 600mm feet + fixing kit)
FF-600-3-ASN-KIT	Flexi-FOOT Kit - 600 narrow (3 x FF-600-ASN + fittings kit)
FF-600-S-150-KIT	flexi-FOOT Kit - 600 x 150 high (2 x 600mm x 150mm feet + fixing kit)
FF-600-S-150-KIT-3	flexi-FOOT Kit - 600 x 150 high (3x 600mm x 150mm feet + fixing kit)
FF-1000-S-KIT	flexi-FOOT Kit - 1000 (2 x 1000mm feet + fixing kit)

ROTARY ISOLATORS

Our insulated 3 and 4 pole rotary enclosed isolators are CE marked and suitable for disconnecting the power supply to outdoor air source heat pump units.

They are waterproof to IP65 and easy to install and conform to IEC 60947-3. They have a lockable off position and interlocking cover which can be removed only in the off position. Earth and neutral terminals included and M20/25 knockouts up to 63A.



Part code	No of poles	AMPS AC21	AC23 A 240VA	AC23 A 400VA	Cable capacity		Height	Width	Depth
					Solid	Stranded			
IS-3P-20A-S	3	20amp	5.5kW	3.7kW	1-16mm ²	0.75-10mm ²	125mm	100mm	120mm
IS-3P-32A-S	3	32 amp	11kW	7.5kW	1-16mm ²	0.75-10mm ²	125mm	100mm	120mm
IS-3P-20A	3	20amp	5.5kW	3.7kW	1-16mm ²	0.75-10mm ²	175mm	114mm	135mm
IS-3P-32A	3	30amp	11kW	7.5kW	1-16mm ²	0.75-10mm ²	175mm	114mm	135mm
IS-3P-40A	3	40amp	15kW	11kW	1-16mm ²	0.75-10mm ²	175mm	114mm	135mm
IS-3P-63A	3	63amp	22kW	18.5kW	1-16mm ²	0.75-10mm ²	175mm	114mm	135mm

IS-4P-20A-S	4	20amp	5.5kW	3.7kW	1-16mm ²	0.75-10mm ²	125mm	100mm	120mm
IS-4P-32A-S	4	32 amp	11kW	7.5kW	1-16mm ²	0.75-10mm ²	125mm	100mm	120mm
IS-4P-20A	4	20amp	5.5kW	3.7kW	1-16mm ²	0.75-10mm ²	175mm	114mm	135mm
IS-4P-32A	4	32amp	11kW	7.5kW	1-16mm ²	0.75-10mm ²	175mm	114mm	135mm
IS-4P-40A	4	40amp	15kW	11kW	1-16mm ²	0.75-10mm ²	175mm	114mm	135mm
IS-4P-63A	4	63amp	22kW	18.5kW	1-16mm ²	0.75-10mm ²	175mm	114mm	135mm

INSTALLING



FILL AND FLUSH FLOW SETTER

Ensures correct flow rate into the heat exchanger and allows for easy filling and draining of the system.

- 1" BSP Female Connectors
- 2 x 14mm Barbed Hose fittings.



Part code	Description
FBV-F&F-1-FF	Fill & Flush Flow setter 1" female/female

ACCESSORIES

FLEXI FOOT FIX CLAMP

PART NO FF-FIXCLAMP

The fix clamp allows you to secure flexi feet to the floor using anchor bolts. Fixings not supplied



ANTI VIBRATION MOUNTING BOLTS

PART NO AVMB-1

Pack of 4 anti-vibration bolts. Can be used with all DiversiTech International wall brackets



FLOOR BRACKET KIT

PART NO CCTM-FLOOR-BRKT-KIT

Brackets to allow a condensate tray to be mounted on to flexifeet. The ASHP can then be mounted on the brackets.



Part code	Description
CCTM-FLOOR-BRKT-KIT	Stainless Floor Bracket Kit for drip trays - 4 x brackets and fixings
CCTM-FLOOR-BRKT-KIT3	Stainless Floor Bracket Kit for drip trays - 6 x brackets and fixings

INSTALLING



ACCESSORIES

ASHP SOAK-AWAY



This unique pre-bagged geo textile soakaway is used to safely dispose of the condensate from all domestic sized air source heat pumps where drain routing is not available. The volume of condensate created from an air source heat pump up to 16kW can be between 10-15 litres per hour up to 2000 litres per year. This method prevents the condensate from flowing onto paths and driveways, which can freeze and cause a slip hazard.

- Alternative method to condensate removal disposal
- Suitable for all models/brands of air source heat pumps
- Made from pre-bagged geo-textile material to prevent soil ingress
- 32mm inlet
- Capacity - 10-15 litres per hour
- Helps with MIS 3005 compliance and complies with BRE 365

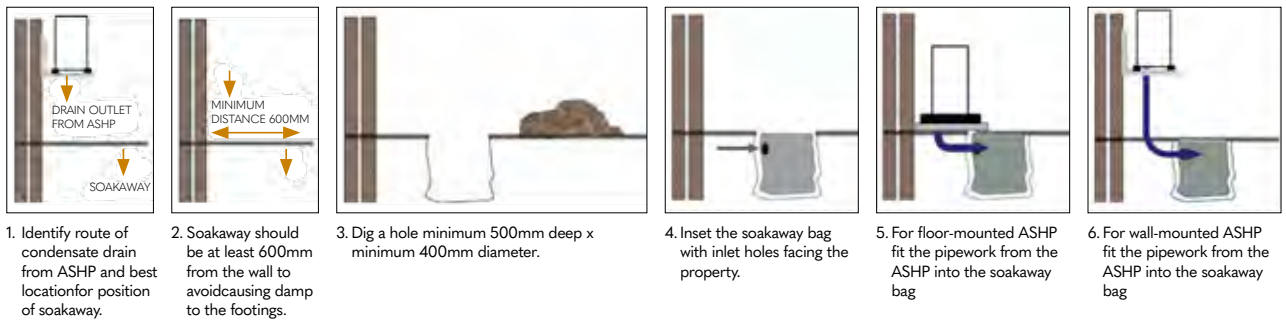

Part code	Description	Inlet	Diameter	Height
ASHP-SOAK	Air source heat pump soakaway - pre bagged geo textile with rubber chippings	32mm	400mm	400mm



FLEXIBLE CONNECTION HOSES

Our flexible hoses meet the requirements of MCS MIS 3005, and help to avoid transmission of vibration through the pipework.

The 28mm hose is sleeved within a stainless steel braid for added protection. All hoses come with 19mm wall insulation which is weatherproof and UV stable.



SOLD IN PAIRS

Part code	Description
FH-300-28-F-ELBOW	Flexible ASHP Hose Pair -300mm x 28mm - 1" FEMALE c/w elbow
FH-300-28-1-1/4ELB	Flexible ASHP Hose Pair -300mm x 28mm - 1 1/4" FEMALE c/w elbow
FH-500-22-F	Flexible ASHP Hose Pair -500mm x 22mm - 1" FEMALE
FH-500-28-F	Flexible ASHP Hose Pair -500mm x 28mm - 1" FEMALE
FH-750-28-F	Flexible ASHP Hose Pair -750mm x 28mm - 1" FEMALE
FH-750-28-M	Flexible ASHP Hose Pair-750mm x 28mm - 1" MALE
FH-750-28-F-ELBOW	Flexible ASHP Hose Pair -750mm x 28mm - 1" FEMALE c/w elbow
FH-750-28-1-1/4F	Flexible ASHP Hose Pair -750mm x 28mm - 1 1/4" FEMALE
FH-750-28-1-1/4M	Flexible ASHP Hose Pair -750mm x 28mm - 1 1/4" MALE

PVC COATED EXTERNAL GRADE INSULATION

External condensate pipe work needs to be insulated in a tough PVC coated weather protected covering to avoid UV degradation and animal damage. Boiler installation standards BS 6798-2104 makes specific reference to this grade of insulation. ASHP and Biomass Boilers tend to be located externally and this hot water pipe work needs to be protected and insulated to avoid heat loss, MIS3005 and building regulations advise a certain thickness of insulation to meet heat loss requirements. Our PVC coated range helps installations comply in both boiler condensate and ASHP installations



Part code	Description	Length	Diameter	Thickness	ID
FH-I-1000-15	PVC Coated Weather & Waterproof Insulation	1000mm	41mm	13mm	15mm
FH-I-1000-22	PVC Coated Weather & Waterproof Insulation	1000mm	60mm	19mm	22mm
FH-I-1000-28	PVC Coated Weather & Waterproof Insulation	1000mm	66mm	19mm	28mm
FH-I-1000-28-F	PVC Coated Weather & Waterproof Insulation	1000mm	66mm	19mm	28mm
FH-I-1000-35	PVC Coated Weather & Waterproof Insulation	1000mm	73mm	19mm	35mm
INS-TAPE-10-PK	PVC Coated Weather & Waterproof Tape	250mm	50mm	1mm	10 pack

INSULATING



PRE SLIT AND SEAL INSULATION

Our new insulation provides outstanding protection against the elements for external pipework on boiler condensate ASHP and Biomass boilers.

The new design offers a quick and secure 'tape free' installation with its peel and seal join and self adhesive wrap-over flap. The tough PVC coating is both weatherproof and UV stable.



Part code	Size	Internal diameter
FH-I-1000-22-SLIT	1000mm L x19mm Thickness	22mm ID
FH-I-1000-28-SLIT	1000mm L x19mm Thickness	28mm ID
FH-I-1000-35-SLIT	1000mm L x19mm Thickness	35mm ID
INS-TAPE-10-PK	PVC Coated Weatherproof Insulation Tape	Length 250mm, Width 50mm x 1mm (pack 10)

THROUGH THE WALL INSULATION KIT

Pipe work running through the wall will be affected by cold bridging and heat loss if it's not insulated correctly. MIS 3005 requires external pipework to be properly insulated.

This provides both thermal insulation within the wall and comes complete with an elbow section to cover the external copper pipe connection.



Part code	Size
TW-KIT	Through the Wall Insulation Kit



ASHP GUARDS

DiversiTech International manufacture a range of weather-resistant, steel mesh guards, offering a safe solution to avoid vandalism or accidental damage of your expensive ASHP. The range is ideal for all manufacturers of ASHP units. The unique sliding panel system allows for easy installation, which are secured into place when the front panel is fitted. Back panels are also available to make the guard free standing. For high wall mounted units, we can offer a base panel for full security.



Part code	Size	External dimensions			Internal dimensions			Weight
		Height	Width	Depth	Height	Width	Depth	
CG-750-S	S	950mm	1150mm	750mm	920mm	1120mm	740mm	25kg
CG-750-S-INV	S	950mm	1450mm	750mm	920mm	1420mm	740mm	25.1kg
CG-750-M	M	1150mm	1150mm	750mm	1120mm	1120mm	740mm	32kg
CG-750-L	L	1450mm	1150mm	750mm	1420mm	1120mm	740mm	33kg
CG-750-INV	INV	1150mm	1450mm	750mm	1120mm	1420mm	740mm	33kg

Part code	Size	Height	Width	Depth	Height	Width	Depth	Weight
CG-900L-INV	L	1150mm	1450mm	900mm	1120mm	1420mm	890mm	34kg
CG-900L-SQ	L-SQ	1450mm	1450mm	900mm	1420mm	1370mm	890mm	51kg
CG-900-XXL	XXL	1800mm	1450mm	900mm	1770mm	1370mm	890mm	60kg

Part code	Size	Height	Width	Depth	Height	Width	Depth	Weight
CG-S	S	750mm	1050mm	460mm	720mm	1020mm	450mm	18kg
CG-M	M	1150mm	1150mm	650mm	1120mm	1120mm	640mm	27kg
CG-L	L	1450mm	1150mm	650mm	1420mm	1120mm	640mm	30kg
CG-XL	XL	1800mm	1150mm	650mm	1770mm	1120mm	640mm	40kg

WOODEN CONDENSER GUARDS

Made from tanalised, pressure-treated timber. All panels have rounded louvers to optimise air flow. Sized to protect both ASHP and AC units, these guards offer a solution for listed buildings and sites where aesthetics are a consideration. All components are flat-packed for easy transport, and easy-to-install and assemble.



Part code	Description	External dimensions			Internal dimensions		
		Height	Width	Depth	Height	Width	Depth
CG-750S-WOOD	Small Guard	905/960	1275	865	850/890	1050	753
CG-750M-WOOD	Medium Guard	1135/1135	1275	865	1075/1115	1055	753
CG-750M+WOOD	Medium+ Guard	1255/1310	1275	865	1200/1240	1055	753
CG-750L-WOOD	Large Guard	1530/1585	1275	865	1475/1515	1055	753
CG-750L- INV-WOOD	Large Inv Guard	1130/1185	1630	865	1075/1115	1405	753
CG-750L+WOOD	Large+ Guard	1600/1655	1275	865	1545/1585	1055	753
CG-750L+INV-WOOD	Large+ Inv Guard	1655/1690	1630	865	1580/1620	1405	753

PROTECTING

EXTERNAL TRUNKING

Pipework and insulation running from an air source heat pumps should be protected. Our range of trunking comes in a 140mm width with an ivory or black option and accommodates both the insulated flow and return pipework along with any associated cabling.

- Easy to install
- 140mm wide
- Provides a professional and neat finish
- Made from high grade, UV stable, fade resistant PVC
- Available in Ivory and Black
- Protection from the elements, accidental damage and pest damage



Ivory part code	Description	Size (depth x width)
TR-D-140	140mm Trunking (2000mm Length)	90mm x 140mm
TR-WC-140	140mm Wall Cover	90mm x 140mm
TR-CP-140	140mm Straight Connector	90mm x 140mm
TR-IC-140	140mm 90 Degree Internal Bend	90mm x 140mm
TR-FB-140	90 Degree Flat Bend	90mm x 140mm
TR-EC-140	90 Degree External Bend	90mm x 140mm

Black part code	Description	Size (depth x width)
TR-D-140-B	140mm Trunking (2000mm Length)	90mm x 140mm
TR-WC-140-B	140mm Wall Cover	90mm x 140mm
TR-CP-140-B	140mm Straight Connector	90mm x 140mm
TR-EC-140-B	140mm Straight Connector	90mm x 140mm
TR-IC-140-B	140mm 90 Degree Internal bend / External bend	90mm x 140mm
TR-FB-140-B	90 Degree Flat Bend	90mm x 140mm
TR-EC-140-B	90 Degree External Bend	90mm x 140mm

COIL CLEANING

Heat exchangers can get clogged with dirt and debris. It's essential to keep these clean to maintain optimum efficiency. Pro-green is an environmentally friendly cleaner for ASHP heat exchangers. Available ready-mixed or concentrated.



Part code	Description
G2G-Green+	G2G Green 1 Litre pre-mixed Coil Cleaner Spray
Pro-Green-GB	Pro-Green 5 Litre Concentrated Coil Cleaner

REFRIGERANT LEAKS

SUPER SEAL LEAK SEALANT

Super Seal™ is a system additive that will find and seal leaks in the refrigeration circuit of an ASHP. It also has an eliminator to dry any moisture in the system preventing acid/waxing, and dissolves blockages and frees TEV's.

COMPATIBLE WITH ALL OILS AND REFRIGERANTS.



Part code	Description	Contents
947-KIT	Small Systems Up To 5kW	30ml
944-KIT	Medium Systems from 5-17 kW	59ml
948-KIT	Large Systems over 17kW	89ml

BUBBLE-UP LEAK SPRAY

Leak Seek is a leak detection spray designed to locate refrigerant leaks. Suitable for high and low pressure leaks, this formulation is alcohol and solvent free and has long lasting bubbles.



Part code	Description
AER-B-500	500ml Leak Detection Spray

ELECTRONIC LEAK DETECTOR - TIF XP-1A

The TIF XP-1A detects all HFC, HFO and HCFC refrigerants, and will find a leak as small as 3 grams per year. Requires 2 x 'C' Batteries.



Part code	Description
TIF-XP1A	TIF Electronic Leak Detector

LUBRICANTS.
TECHNOLOGY.
PEOPLE.



RENISO TRITON SE/SEZ

Synthetic refrigeration oils based on poly esters (POE) for HFC/FC refrigerants

RENISO C 85 E

Synthetic refrigeration oil for CO₂ compressors

RENISO PAG 100

Special polyalkylene glycols (PAG) for mobile AC systems

FUCHS RANGE

PAGE 135

DIVERSITECH[®]
INTERNATIONAL



**AUTHORISED
PARTNER**

FLEXI SUPPORT

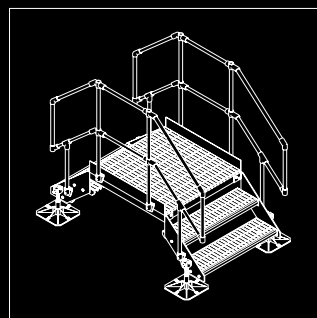
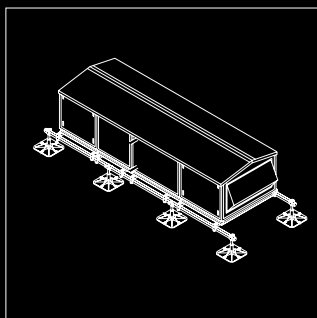
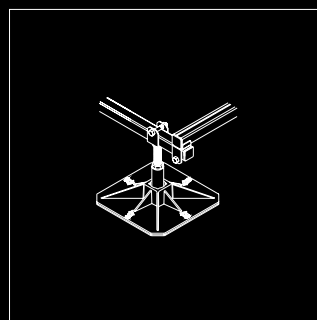
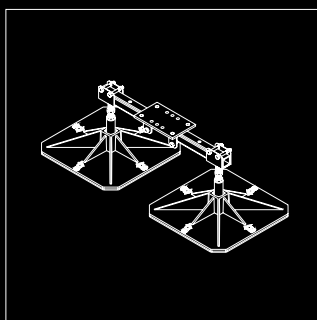

FLEXI BASE & EXTENDER FRAMES

BASE & EXTENDER frames are designed to provide stability and spread loads evenly across flat roof surfaces. Modular frames are ideal for a/c split systems and VRV/ VRF systems.

The galvanised steel frame raises equipment up to 405mm (higher heights available) above the flat roof level, permitting quick and easy access for roof maintenance.



STEP 1.
ASSEMBLE A BASE FRAME

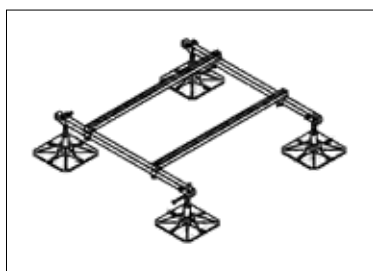

ORDER PH-BF-B

STEP 2.
NEED A BIGGER FRAME? ADD AN
EXTENDER FRAME

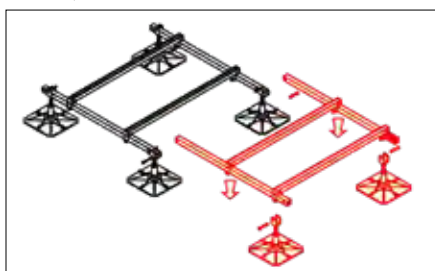

ORDER PH-EF-B

STEP 3.
CONNECT THE BASE AND EXTENDER
FRAMES TOGETHER

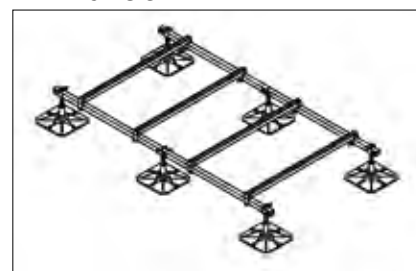

ORDER PH-BF-B & PH-EF-B

Item	Material
FEET	Square - 320mm square UV stabilised - 90% polypropylene and 10% grp
LEGS	"48mm diameter, 3mm galvanised steel tube. M24 galvanised steel height adjust er. 3mm galvanised steel U -clevis"
BOX BEAMS	40mm x 40mm x 2.5mm galvanised box section
CROSS BEAMS	41mm x 41mm x 2.5mm galvanised steel slotted strut
FIXING BOLTS	M12 spun galvanised



Code	Description	Length	Width	Min. Height	Max. Height	"Safe Working Load**"	Weight
PH-BF-B	Flexi Base Frame	1200mm	1200mm	300mm	405mm	500kg	30kg
PH-EF-B	Flexi Extender Frame	1200mm	1200mm	300mm	405mm	500kg	24kg

EVERYDAY - FLEXI H-FRAME KITS

Our H-frame kits offer the installer full flexibility by providing a solution where they can supply their own strut to suit their installation requirements.

The H-frame kits are supplied with a pair of either our 305 or 320mm feet, most widely used in the majority of installations, or where heavier more demanding loads are present, then our 500mm foot version kit is available.

All kits are supplied with hot dip galvanised angle brackets together with all the necessary fixings to assist the installer in a low cost, versatile and fast assembly solution on site.



Part code	Description	Foot size	Safe working load*	Weight
F-HF-305	Flexi H-Frame Kit - 2 square block feet with fittings*	305mm x 305mm	105kg	2.8kg
F-HF-320	Flexi H-Frame Kit - 2 square block feet with fittings*	320mm x 320mm	250kg	4kg
F-HF-500	Flexi H-Frame Kit - 2 square block feet with fittings*	500mm x 500mm	600kg	13kg

Complete strut assembled frameworks, (H-frame kits where the strut is also supplied), are available upon request.

Item	Material
FEET	Square - 305mm, 320mm and 500mm square UV stabilised - 90% polypropylene and 10% grp
MAT	100% natural rubber, (mat is adhered to the feet)
FIXINGS	M10 ZP sets, spring washers and nuts
ANGLE BRACKETS	Mild steel, hot dipped galvanised BS EN ISO 1461:2009

* NB - the lengths of the strut are not supplied with this kit. ** As the strut is not supplied with the kit, the maximum load is a guide only.

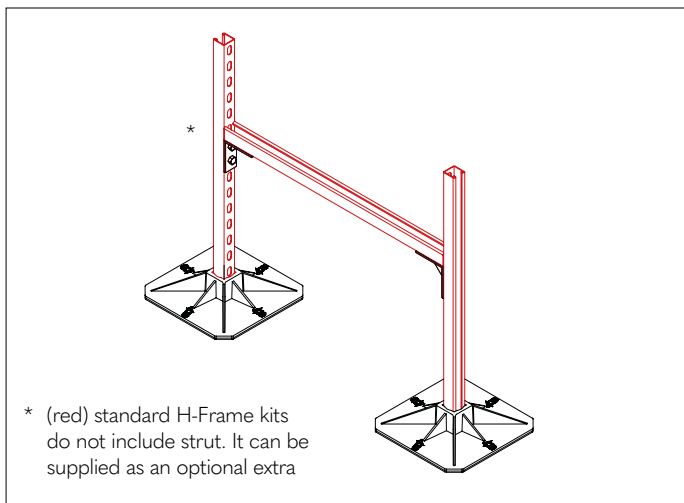

** It is the installer's responsibility to ensure that equipment weights do not exceed the safe working loads quoted and that the roof structure onto which these products are being applied is sufficiently sound to withstand the weight and point loading. If these products are used in contact with a PVC/TPO roof membrane the installer should seek advice from the membrane manufacturer on the possible migration of plasticizers and the effect of this on the roof guarantee. These products should

not be used for any purpose other than that for which they have been designed and the products must not be modified in any way. Pump House accepts no liability for damage caused by the incorrect application or installation of these products..

EVERYDAY - FLEXI FOOT WITH STRUT

Flexi Foot With Strut – These feet can support pipework, cable tray, and can also be used to mount air conditioning units, air source heat pumps and a variety of outdoor equipment.

Solar thermal and solar photovoltaic on flat roof installations can also be accommodated. Made from heavy duty recycled rubber. The 21x41mm galvanised steel strut is supplied bonded

to the rubber. Drain slots are molded to the underside of the foot.



Item	Material
RUBBER	Compression moulded using milled, sieve d and graded, recycled rubber bound with high quality adhesive
DENSITY	1.0kg / cm ³
STRUT	41 x 21 x 1.5mm galvanised steel



Part code	Description	Length mm	Width mm	Height mm	Safe Working Load*	Weight
FF-250-S	Flexi Foot With Strut - 250mm	250	185	100	175kg	2.8kg
FF-400-S	Flexi Foot With Strut - 400mm	400	185	100	280kg	4.6kg
FF-600-S	Flexi Foot With Strut - 600mm	600	185	100	420kg	7.6kg
FF-1000-S	Flexi Foot With Strut - 1000mm	1000	185	100	700kg	12.0kg

Part code	Description	Length mm	Width mm	Height mm	Safe Working Load*	Weight
FF-250-S-P-L	Flexi Foot With Strut - 250mm - Low Profile	250	185	50	100kg	1.4kg
FF-400-S-P-L	Flexi Foot With Strut - 400mm - Low Profile	400	185	50	150kg	2.3kg
FF-600-S	Flexi Foot With Strut - 600mm	600	185	100	420kg	7.6kg
FF-1000-S	Flexi Foot With Strut - 1000mm	1000	185	100	700kg	12.0kg

EVERYDAY - FLEXI FOOT UNIVERSAL

The Flexi Foot Universal has three M10 inserts, offering support for small pipework and runs of cable tray, for air source heat pumps and a variety of outdoor equipment. The installer is free to bolt their own strut of various lengths to suit any installation from 500mm to 3000mm in length. It can also be used to support both solar thermal and solar photovoltaic on flat roof installations.



Part code	Description	Length mm	Width mm	Height mm	Safe Working Load*	Weight
FF-250-UNI	Flexi Foot Universal - 250mm	250	185	100	125kg	2.8kg

Item	Material
RUBBER	Compression moulded using milled, sieved and graded, recycled rubber bound with high quality adhesive
DENSITY	1.0kg / cm ³
INSERTS	M10 (metric course thread) x 20mm zinc plated steel , through inserts
MAX. TORQUE (INSERTS)	15Nm
MAX. LOAD (INSERTS)	25kg

* The maximum load quoted is 25kg per insert and have been tested with a 4:1 safety ratio.

FLEXI FIX CLAMP

The Flexi Fix Clamp is used to add stability particularly with twin fan units. The Fix Clamp can be secured to the floor with anchor bolts.



Part code	Description	Length mm	Width mm	Height mm
FF-FIXCLAMP	Flexi Foot Fix Clamp	240	60	103

FLEXI FIX PACKS

To complement our range of Flexi Feet we have created two versions of fix packs in either spring nut or T bolt. The packs contain bolts, nuts and washers for the installation of a pair of feet for a single condensing unit.



Code	Description
FF-FIX-PACK	Components with spring bolts to secure an outdoor AC unit - for 2 Flexi Feet
FF-FIX-2	Components with T bolts to secure an outdoor AC unit - for 2 Flexi Feet

PROTECTION FLEECE

Geotextile polyester fleece for PVC/TPO field membrane protection. Sold by linear metre. Please specify requirements.



Part code	Description	Density
MPF-12	Protection Fleece - 2000mm x 1000mm	300gsm

FLEXI FOOT VARIATIONS

To complement our range of Flexi Feet we have a number of variations on the standard flexi foot with strut. The foot only options are available in 200, 350 and 500mm with angle pitch variants.



Part code	Description	Length mm	Width mm	Height mm	Safe Working Load**	Weight
PH-FO-200	Flexi Foot - 200mm for vertical strut / M10 thread	200	200	85	100kg	2.3kg
PH-FO-350	Flexi Foot - 350mm for vertical strut	350	350	110	150kg	5.7kg
PH-FO-350-2	Flexi Foot - 350mm for vertical 82x41mm strut	350	350	110	150kg	5.7kg
PH-FO-350-2.5-S	Flexi Foot - 350mm for vertical 2.5 degree	350	350	125	150kg	5.9kg
PH-FO-350-5.0-S	Flexi Foot - 350mm for vertical 5.0 degree	350	350	140	150kg	6.1kg
PH-FO-500	Flexi Foot - 500mm for vertical strut	500	500	110	150kg	10.5kg
PH-FO-500-2	Flexi Foot - 500mm for vertical 82x41mm strut	500	500	110	150kg	10.5kg
PH-FO-500-2.5	Flexi Foot - 500mm for vertical 2.5 degree	500	500	130	150kg	10.7kg
PH-FO-500-5.0	Flexi Foot - 500mm for vertical 5.0 degree	500	500	150	150kg	10.9kg

FLEXI FOOT VARIATIONS

Lightweight support that may be used with horizontal or vertical strut to support low level cable tray and other services.

- Accepts 41mm x 41mm strut vertically into core
- Accepts 41mm x 41mm strut horizontally via fixing screw (supplied)
- Foam anti-vibration pad pre-fitted to the base
- Made from UV-stable pvc, strut not supplied



Part code	Description	Length mm	Width mm	Height mm	Safe Working Load**	Weight
F-MF-110	Flexi Foot mini - 110mm	110mm	110mm	60mm	-	-
F-MF-160	Flexi Foot mini - 160mm	160mm	160mm	60mm	50kg	230g

WALKWAY MAT

Walkway mats may be combined to define a safe access path whilst protecting the roof surface.



Part code	Description	Safe working load	Crossbar	Arm length	Weight
CBR2-EL	Economy bracket with crossbar	140kg*	800mm	550mm	3.73kg
CBE-140	Economy bracket with crossbar	140kg*	1000mm	550mm	5.5kg

** It is the installer's responsibility to ensure that equipment weights do not exceed the safe working loads quoted and that the roof structure onto which these products are being applied is sufficiently sound to withstand the weight and point loading. If these products are used in contact with a PVC/TPO roof membrane the installer should seek advice from the membrane manufacturer on the possible migration of plasticizers and the effect of this on the roof guarantee. These products should not be used for any purpose other than that for which they have been designed and the products must not be modified in any way. Pump House accepts no liability for damage caused by the incorrect application or installation of these products.

HEAVY - FLEXI TWIN FRAMES

Frames for large pipes, air handling units, chillers and packaged plant rooms. These robust & versatile free standing modular frames are supplied with fully adjustable leg assemblies in 500mm square polypropylene feet, incorporating anti-vibration rubber mats adhered to the underside. Robust 50 x 50mm box cross bars are 5mm thick to cater for mid-span point loads, resulting in even load dispersal through the framework down to each foot.



The optional mounting plate can be purchased in addition or as an alternative to the adjustment being in the leg assemblies. Therefore a non-adjustable twin is also available.

Application: Suitable for heavier building services such as large air handling units, chillers and packaged plantrooms. An ideal solution when the criteria to target existing roof beams is necessary. The twin frames can be targeted immediately above to assist direct load transfer to existing roof beams below: a common requisite in weaker roof designs.

Item	Material
FEET	Square - 500mm square UV stabilised - 90% polypropylene and 10% grp
MAT	100% natural rubber, (mat is adhered to the feet)
LEGS	48mm dia. 3mm stud steel tube with M24 stud adjuster and 4mm thick U clevis to top
CROSS BARS	50x50x5mm SHS (Square hollow section) with optional mounting plate if required
FINISH	"Hot dip galvanised steelwork BS EN 10219-1: 2006 Galvanising BS EN ISO 1461:2009 Salt Mist Testing : BS EN 60068-2-52-2018"



DOUBLE MOUNTING PLATE
PART CODE - F-TQ-ADJ-D



SINGLE MOUNTING PLATE
PART CODE - F-TQ-ADJ-S

Part code	Description	Length mm	Width mm	Height mm	Weight	Max Load
F-TWIN-320-A	Flexi TWIN (adjustable legs)	1020mm	320mm	250-380mm	14kg	350kg
F-TWIN-500-A	Flexi TWIN (adjustable legs)	1200mm	500mm	250-380mm	30kg	1000kg
F-TQ-ADJ-S	Single Mounting Plate	250mm	150mm	-	3kg	-
F-TQ-ADJ-D	Double Mounting Plate	250mm	150mm	170mm (adjustable)	8kg	-
PH-WW-MAT-1000-17						
PH-WW-MAT-500						

NEED INFO

HEAVY - FLEXI QUAD FRAMES

These robust & versatile free standing modular frames are supplied with fully adjustable leg assemblies and 500 x 500mm polypropylene feet, which incorporates anti-vibration rubber mats adhered to the underside.

Robust 50 x 50mm box end bars and cross bars both being 5mm thick in section, cater for picking up the point load mid span, resulting in even load dispersal through the framework down to the feet. The optional adjuster plate can also be purchased and these are supplied with fixings.



Application: Suitable for heavier building services such as large air handling units, chillers and packaged plantrooms. Quads are particularly useful for managing heavy loads, and as a direct replacement for traditional concrete plinths, as they can be re-positioned to accommodate late design changes

Item	Material
FEET	Square - 500mm square UV stabilised - 90% polypropylene and 10% grp
MAT	100% natural rubber, (mat is adhered to the feet)
LEGS	48mm dia. 3mm stud steel tube with M24 stud adjuster and 4mm thick U clevis to top
END BARS	50x50x5mm SHS (Square hollow section)
CROSS BARS	50x50x5mm SHS (Square hollow section) with optional mounting plate if required
FINISH	"Hot dip galvanised steelwork BS EN 10219-1:2006 Galvanising BS EN ISO 1461:2009. Salt Mist Testing: BS EN 60068 -2-52:2018"



DOUBLE MOUNTING PLATE
PART CODE - F-TQ-ADJ-D



SINGLE MOUNTING PLATE
PART CODE - F-TQ-ADJ-S

Part code	Description	Length mm	Width mm	Height mm	Weight	Max Load
F-QUAD-320-A	Flexi QUAD (adjustable legs)	1061mm	1020mm	305-435mm	60kg	2000kg
F-QUAD-500-A	Flexi QUAD (adjustable legs)	1241mm	1200mm	305-435mm	64kg	2000kg
F-TQ-ADJ-S	Single Mounting Plate	250mm	150mm	-	3kg	-
F-TQ-ADJ-D	Double Mounting Plate	250mm	150mm	170mm (adjustable)	8kg	-

HEAVY - FLEXI MODULAR FRAMES

Modular robust frames for large air handling units.

These robust free standing modular frameworks are supplied with fully adjustable leg assemblies and 500 x 500mm polypropylene feet, incorporating anti-vibration rubber mats adhered to the underside. Robust 50 x 50mm square hollow section end bars are 2.5mm thick and are supplied with either 50 x 50mm, or 100 x 50mm cross bars. With a variety of sizes available for both our end bars and cross bars, a suitable framework can be designed to suit many applications where a strong support is key.

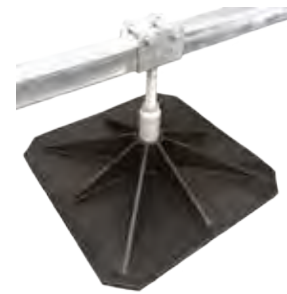

Application: Suitable for heavier building services such as large air handling units, chillers and air cooled condensers. Our unique 'drop on' cross bars offer a faster alternative when erecting the framework compared with some slide on systems.

Item	Material
FEET	Square - 500mm square UV stabilised - 90% polypropylene and 10% grp
MAT	100% natural rubber, (mat is adhered to the feet)
LEGS	48mm dia. 3mm stud steel tube with M24 stud adjuster and 4mm thick U clevis to top
END BARS	50x50x2.5mm SHS (square hollow section)
CROSS BARS	50x50x3mm SHS & 100x50x3mm (square/ rectangular hollow section)
FINISH	Hot dip galvanised steelwork BS EN 10219-1:2006 Galvanising BS EN ISO 1461:2009. Salt Mist Testing: BS EN 60068 -2-52:2018



Part code	SHS Section	1000mm	1500mm	2000mm	2500mm	3000mm	3500mm
END BAR	50x50x2.5	PHF-005A	PHF-005B	PHF-005C	-	PHF-005D	-
CROSS BAR	50X50X3.0	-	PHF-016	-	-	-	-
CROSS BAR	100X50X3.2	-	-	PHF016A	PHF-016B	PHF-016C	PHF-016D
F-TQ-ADJ-D	Double Mounting Plate	250mm	150mm	170mm (adjustable)	8kg	-	-

HEAVY - FLEXI CUSTOM FRAMES

Custom robust frameworks for the support of complex and heavy building services.

These custom solutions are frequently manufactured from 100 x 50mm parallel flange channel and/or 100x 100mm HEB (European Beam) and supported off fully adjustable leg assemblies utilising our larger 500 x 500mm polypropylene feet, incorporating anti-vibration rubber mats adhered to the underside. However larger steel sections are available dependant on project requirement and/or mass or size of the services being supported. All frameworks are hot dip galvanised. We will provide an AutoCAD drawing proposal together with load calculations prior to manufacture.



Application: Suitable for heavier chillers, packaged plantrooms, or complex shaped building services, typically air handling units. Steelwork comes with all necessary fixings and the correct amount of leg assemblies/feet. These are manufactured in the UK offering a very fast lead time.

Item	Material
FEET	Square - 500mm square UV stabilised - 90% polypropylene and 10% grp
MAT	100% natural rubber, (mat is adhered to the feet)
LEGS	Custom manufactured to suit most heights and welded frames. Supplied with M24 adjuster stud for levelling
FRAME	Dependant on load/span
FINISH	Hot dip galvanised steelwork BS EN 10219-1:2006 Galvanising BS EN ISO 1461:2009. Salt Mist Testing: BS EN 60068 -2-52:2018



Information required	AHU Requirements	Chiller Requirements	Packaged Plantroom Requirements
	1	Sectional quantity	AVM quantity & point loads
2	Sectional dimensions	AVM dimensional locations	Sectional dimensions
3	Sectional weight	Total weight (operating mass)	Total weight (operating mass)
4	Overall dimensions & weight	Overall dimensions	Overall dimensions

ACCESS - FLEXI STEP-OVERS & HOP-OVERS

Safe access solutions designed and manufactured to current British Standards.

With the introduction of The Work at Height Regulations back in 2005, the regulations apply to all work at height where there is a risk of a fall liable to cause personal injury. This regulation places duty on employees, the self employed and any person that controls the work of others, e.g. facility managers, building owners/end users etc. Flexi access solutions are designed to current British Standards; we offer full working drawings, site surveys and all our access range is manufactured in the UK. GRP options are also available upon request. So whether it's a cat ladder, companion way ladder, stairs, ramps, walkways or a combination of all these, flexi access will provide you and your workforce with a safe access solution. We can also offer a custom design service to suit your needs.



Application: Step-Overs to bridge ducts, pipes and electrical containment; custom solutions to access maintenance doors to AHU's chillers or other rooftop services, ramped access solutions where wheel barrow / sack barrows are used and straight forward elevated access solutions. Cat ladders and companion way ladder also available.

Item	Material
FEET	Square - 320mm square UV stabilised - 100% polypropylene
MAT	320mm feet only - 100% natural rubber, (mat is adhered to the feet)
LEGS	Step-Overs; 48mm dia. 3mm stud steel tube with M24 stud adjuster and 3mm thick U clevis to top
LEGS	Hop-Overs; 40x40x2mm SHS (Square hollow section)
HAND RAILS	33.7mm diameter mild steel
TREADS / FLOORING	25x3mm open grid flooring. (41/100 bearing bars) and designed to 7.5 Kn/M ² Loading BS4592 part 1
FINISH	Hot dip galvanised steelwork BS EN 10219-1:2006 Galvanising BS EN ISO 1461:2009. Salt Mist Testing: BS EN 60068 -2-52:2018



Part code	Description	Thread QTY	Landing size 99	Clearance height mm	Foot size
F-SO-2	Flexi Step Over 2 up / 2 down	2 up / 2 down	1000mm x 1000mm	560mm	320mm x 320mm
F-SO-3	Flexi Step Over 3 up / 3 down	3 up / 3 down	1000mm x 1000mm	780mm	320mm x 320mm
F-SO-4	Flexi Step Over 4 up / 4 down	4 up / 4 down	1000mm x 1000mm	1000mm	320mm x 320mm
F-HO-600	Flexi Hop Over - 600mm	-	1000mm x 600mm	180mm	320mm x 320mm
F-HO-1000	Flexi Hop Over - 1000mm	-	1000mm x 1000mm	180mm	320mm x 320mm
F-HO-HR	Flexi Hand Rail for Hop Over	-	-	-	-

ACCESS - FLEXI CUSTOM PLATFORMS & WALKWAYS

A tailored solution to fit around existing rooftop building services.

Flexi custom platforms and walkways are designed to provide solutions for maintenance and fire exit access. We can visit sites and carry out a thorough survey from which we generate AutoCAD drawings. These will be forwarded for approval to the project team prior to manufacture. They are manufactured from mild steel with a hot dip galvanised finish. Alternatively we can offer aluminium or GRP solutions upon request.

Designed to comply with British Standards, these versatile and easy to assemble solutions are supplied with M24 adjustable legs, (to cater for the roof fall), and supported by our 320mm square feet

Application: Generally positioned on flat roofs providing access to rooftop building services and fire exit access solutions.

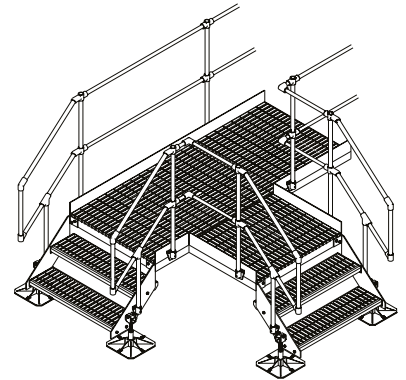

Item	Material
FEET	Square - 320mm square UV stabilised - 100% polypropylene
MAT	320mm feet only - 100% natural rubber, (mat is adhered to the feet)
LEGS	Step-Overs; 48mm dia. 3mm stud steel tube with M24 stud adjuster and 3mm thick U clevis to top
LEGS	Hop-Overs; 40x40x2mm SHS (Square hollow section)
HAND RAILS	33.7mm diameter. Kee Klamp (or similar) c/w interchangeable fittings
TREADS / FLOORING	25x3mm open grid flooring. (41/100 bearing bars) and designed to 7.5Kn/M ² Loading BS4592 part 1
FINISH	Hot dip galvanised steelwork BS EN 10219-1:2006 Galvanising BS EN ISO 1461:2009. Salt Mist Testing: BS EN 60068 -2-52:2018



DIVERSITECH INTERNATIONAL SUPPLY ACCESS SOLUTIONS THAT UTILISE STAIRS, COMPANION WAY LADDERS OR CAT LADDERS, OR A COMBINATION OF ALL OF THESE. RAMPED ACCESS SOLUTIONS ARE ALSO AVAILABLE UPON REQUEST. MANUFACTURED TO CURRENT BRITISH STANDARDS, PUMP HOUSE SUPPLY THE SOLUTIONS FLAT PACKED WITH ALL NECESSARY FIXINGS FOR QUICK ASSEMBLY ON SITE BY OTHERS. WE OFFER AN EFFICIENT MANUFACTURING AND GALVANISING PROCESS AND CAN SUPPLY GOODS TO SITE USUALLY WITHIN 10-15 WORKING DAYS.

FIXINGS

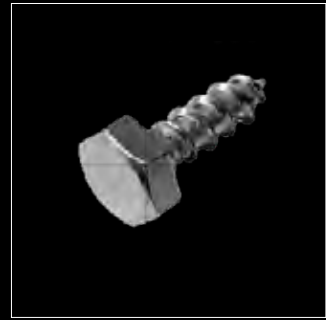
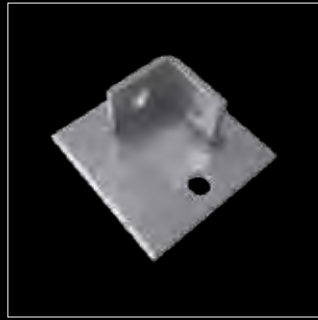
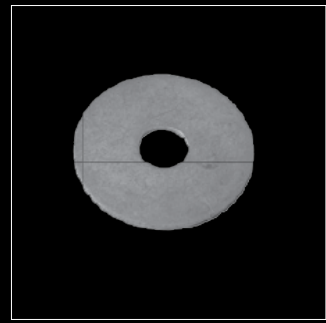

SLOTTED CHANNEL AND ACCESSORIES



SLOTTED CHANNEL

Part code 3m	Part code 6m	Description
X-CH4121-I.5-3M	X-CH4121-I.5-6M	Slotted Channel - 41mm x 21mm x 1.5mm
X-CH4121-2.5-3M	X-CH4121-2.5-6M	Slotted Channel - 41mm x 21mm x 2.5mm
X-CH4141-I.5-3M	X-CH4141-I.5-6M	Slotted Channel - 41mm x 41mm x 1.5mm
X-CH4141-2.5-3M	X-CH4141-2.5-6M	Slotted Channel - 41mm x 41mm x 2.5mm
X-CH4182-2.5-3M	X-CH4182-2.5-6M	Slotted Channel - 41mm x 82mm x 2.5mm

X-CH4121-L.5



BEAM G CLAMP

Part code M6	Part code M8	Part code M10	Part code M12	Description
X-BGC-M6	X-BGC-M8	X-BGC-M10	X-BGC-M12	Beam G Clamp

X-BGC-M8

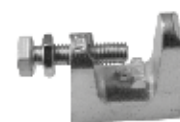

CHANNEL CLAMP

Part code Type 1	Part code Type 2	Part code Type 3	Part code Type 4	Part code Type 5	Part code Type 6	Part code Type 8	Description
X-CBC-1	X-CBC-2	X-CBC-3	X-CBC-4	X-CBC-5	X-CBC-6	X-CBC-8	Channel Clamp



TYPE 5

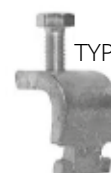

TYPE 6



TYPE 8

SLOTTED CHANNEL

Part code 3m	Description
X-BP810	Back Plate - MB/ MI O
X-CB90-1HI H	90 Degree Bracket - 1 Hole/ 1 Hole
X-CB90-1H2H	90 Degree Bracket - 1 Hole/ 2 Hole
X-CB90-2H2H	90 Degree Bracket - 2 Hole/ 2 Hole
X-CH-4-IS	Channel 4 Way Intersection
X-CH-A	Channel Offset - 45 Degree
X-CHBC-3M	Channel Black Capping - 3 metres
X-CHBPIW-4141	Channel Base Plate - One Way - 41mm x 41mm
X-CHBP2W-4141	Channel Base Plate - Two Way - 41mm x 41mm
X-CH-IA-45	Channel Internal Angle - 45 Degree
X-CH-IA-45135	Channel Internal Angle - 45 Degree 135

X-CH-IA-45

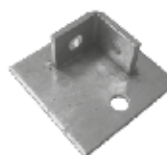

X-CHBP2W-4141

CHANNEL WING FITTING

Part code Type 1	Part code Type 2	Part code Type 3	Part code Type 4	Description
X-CHWF-1	X-CHWF-2	X-CHWF-3	X-CHWF-4	Channel WING FITTING

TYPE 1



TYPE 2



TYPE 3



TYPE 4



CHANNEL U BRACKETS

Part code	Description
X-CBU-4121	Channel U bracket - 41mm x 21mm
X-CBU-4141	Channel U bracket - 41mm x 41mm
X-CBU-4162	Channel U bracket - 41mm x 62mm

X-CBU-4121



CHANNEL Z BRACKETS

Part code	Description
X-CHZB-4121	Channel Z bracket - 41mm x 21mm
X-CHZB-4141	Channel Z bracket - 41mm x 41mm

X-CHZB-4121



WINDOW BRACKETS

Part code	Description
X-CWB-4121	Window bracket - 41mm x 21mm
X-CWB-4141	Window bracket - 41mm x 41mm
X-CWB-4182	Window bracket - 41mm x 82mm

X-CWB-4121



FLAT PLATES

Part code 2-hole	Part code 3-hole	Part code 4-hole	Part code 5-hole	Description
X-FP2H	X-FP3H	X-FP4H	X-FP5H	Flat plate

X-FP4H



OTHER PLATES

Part code	Description
X-FP3H-90	Flat plate - 3-hole - 90 degree
X-TBR4H	T bracket - 4-hole
X-TBR4H-90	T bracket - 4-hole - 90 degree

X-TBR4H



PURLING CLIPS

Part code	Description	Quantity
X-PC	Purling clip Z10 beam clamp	Pack of 100
X-PC-M10	Purling clip - pull on - M10	Pack of 100
X-PC-M8	Purling clip - pull on - M8	Pack of 100

X-PC

X-PC-M8



CHANNEL 4-HOLE INTERNAL/EXTERNAL CONNECTORS

Part code	Description
X-CEC4H-4121	Channel 4-hole external connector - 41mm x 21mm
X-CEC4H-4141	Channel 4-hole external connector - 41mm x 41mm
X-CIC4H-4121	Channel 4-hole internal connector - 41mm x 21mm
X-CIC4H-4141	Channel 4-hole internal connector - 41mm x 41mm

X-CEC4H-4121



X-CIC4H-4121

PLASTIC END CAPS

Part code black	Part code white	Description	Quantity
X-CHCB-4121	X-CHCW-4121	Plastic end caps - 41 mm x 21 mm	Box of 100
X-CHCB-4141	X-CHCW-4141	Plastic end caps - 41 mm x 41 mm	Box of 100
X-CHCB-4121 B6	X-CHCW-4121B6	Plastic end caps - 41 mm x 21 mm	Bag of 6
X-CHCB-4141B6	X-CHCW-4141B6	Plastic end caps - 41 mm x 41 mm	Bag of 6

X-CHCW-4121



X-CHCB-4121

THREADED RODS

Part code M6	Part code M8	Part code M10	Part code M12	Description
X-TR-M6-3M	X-TR-M8-3M	X-TR-M10-3M	X-TR-M12-3M	Threaded rod - 3m length

X-TR-M8-3M



STUDDING CAPS

Part code M6	Part code M8	Part code M10	Part code M12	Description	Quantity
X-SCA-M6	X-SCA-M8	X-SCA-M10	X-SCA-M12	Studding caps	Box of 100
X-SCA-M6-B30	X-SCA-M8-B30	X-SCA-M10-B30	X-SCA-M12-B30	Studding caps	Bag of 30

X-SCA-M8



CABLE TRAY

Part code	Description
X-CTMD-PG-50-3M	Cable Tray - Medium Duty Pre Galv. - 50mm x 3 metres
X-CTMD-PG-75-3M	Cable Tray - Medium Duty Pre Galv. - 75mm x 3 metres
X-CTMD-PG-100-3M	Cable Tray - Medium Duty Pre Galv. - 100mm x 3 metres
X-CTMD-PG-I 50-3M	Cable Tray - Medium Duty Pre Galv. - 150mm x 3 metres
X-CTMD-PG-225-3M	Cable Tray - Medium Duty Pre Galv. - 225mm x 3 metres
X-CTMD-PG-300-3M	Cable Tray - Medium Duty Pre Galv. - 300mm x 3 metres
X-CTMD-PG-450-3M	Cable Tray - Medium Duty Pre Galv. - 450mm x 3 metres
X-CTMD-PG-600-3M	Cable Tray - Medium Duty Pre Galv. - 600mm x 3 metres



CABLE TRAY FLAT BENDS

Part code 90°	Part code 45°	Description
X-CTMD-B-50	X-CTMD-FB-50	Cable Tray Flat Bend - 50mm
X-CTMD-B-75	X-CTMD-FB-75	Cable Tray Flat Bend - 75mm
X-CTMD-B-100	X-CTMD-FB-100	Cable Tray Flat Bend - 100mm
X-CTMD-B-150	X-CTMD-FB-150	Cable Tray Flat Bend - 150mm
X-CTMD-B-225	X-CTMD-FB-225	Cable Tray Flat Bend - 225mm
X-CTMD-B-300	X-CTMD-FB-300	Cable Tray Flat Bend - 300mm
X-CTMD-B-450	X-CTMD-FB-450	Cable Tray Flat Bend - 450mm

X-CTMD-FB-150



CABLE TRAY TEES

Part code	Description
X-CTMD-TP-75	Cable Tray Tee - 75mm
X-CTMD-TP-100	Cable Tray Tee - 100mm
X-CTMD-TP-150	Cable Tray Tee - 150mm
X-CTMD-TP-225	Cable Tray Tee - 225mm
X-CTMD-TP-300	Cable Tray Tee - 300mm
X-CTMD-TP-450	Cable Tray Tee - 450mm

X-CTMD-TP-150



Other cable tray accessories are available upon request and come in light, heavy and hot-dipped galvanised versions.

CABLE TRAY INTERSECTION

Part code	Description
X-CTMD-IS-75	Cable Tray Intersection - 75mm
X-CTMD-IS-100	Cable Tray Intersection - 100mm
X-CTMD-IS-150	Cable Tray Intersection - 150mm
X-CTMD-IS-225	Cable Tray Intersection - 225mm
X-CTMD-IS-300	Cable Tray Intersection - 300mm
X-CTMD-IS-450	Cable Tray Intersection - 450mm

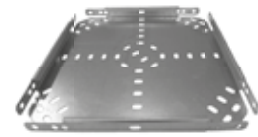

X-CTMD-IS-300

medium and heavy duty versions available

CABLE TRAY REDUCER

Part code	Description
X-CTMD-R-150100	Cable Tray Reducer - 150mm x 100mm
X-CTMD-R-225150	Cable Tray Reducer - 225mm x 150mm
X-CTMD-R-300150	Cable Tray Reducer - 300mm x 150mm
X-CTMD-R-300225	Cable Tray Reducer - 300mm x 225mm
X-CTMD-R-450300	Cable Tray Reducer - 450mm x 300mm
X-CTMD-R-600450	Cable Tray Reducer - 600mm x 450mm



X-CTMD-R-300225

medium and heavy duty versions available

CABLE TRAY HANGER

Part code	Description
X-CTH-PG-50	Cable Tray Hanger - Pre-Galv. - 50mm
X-CTH-PG-75	Cable Tray Hanger - Pre-Galv. - 75mm
X-CTH-PG-100	Cable Tray Hanger - Pre-Galv. - 100mm
X-CTH-PG-150	Cable Tray Hanger - Pre-Galv. - 150mm
X-CTH-PG-225	Cable Tray Hanger - Pre-Galv. - 225mm
X-CTH-PG-300	Cable Tray Hanger - Pre-Galv. - 300mm



X-CTH-PG-100

CABLE TRAY STAND OFF BRACKET

Part code	Description
X-CTMD-SOB-75	Cable Tray Stand Off Bracket - Medium Duty - 75mm
X-CTMD-SOB-100	Cable Tray Stand Off Bracket - Medium Duty - 100mm
X-CTMD-SOB-150	Cable Tray Stand Off Bracket - Medium Duty - 150mm
X-CTMD-SOB-225	Cable Tray Stand Off Bracket - Medium Duty - 225mm
X-CTMD-SOB-300	Cable Tray Stand Off Bracket - Medium Duty - 300mm
X-CTMD-SOB-450	Cable Tray Stand Off Bracket - Medium Duty - 450mm



X-CTMD-SOB-150

Hot-dip galvanised versions available.

CABLE TRAY ACCESSORIES

Part code	Description
X-CTCHD-PG	Cable Tray Coupler - medium duty



BASKET TRAY AND ACCESSORIES



BASKET TRAY

Part code	Description
X-BT-60	Basket Tray - 60mm x 60mm x 3m
X-BT-100	Basket Tray - 100mm x 60mm x 3m
X-BT-150	Basket Tray - 150mm x 60mm x 3m
X-BT-200	Basket Tray - 200mm x 60mm x 3m
X-BT-300	Basket Tray - 300mm x 60mm x 3m
X-BT-400	Basket Tray - 400mm x 60mm x 3m
X-BT-450	Basket Tray - 450mm x 60mm x 3m
X-BT-500	Basket Tray - 500mm x 60mm x 3m
X-BT-600	Basket Tray - 600mm x 60mm x 3m

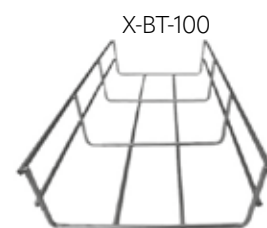

BASKET TRAY QUIK CONNECT

Part code	Description
X-BTM-100	Basket Tray Quik Connect - 100 x 60 x 3mm
X-BTM-150	Basket Tray Quik Connect - 150 x 60 x 3mm
X-BTM-200	Basket Tray Quik Connect - 200 x 60 x 3mm
X-BTM-300	Basket Tray Quik Connect - 300 x 60 x 3mm

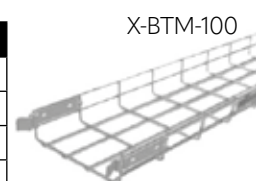

BASKET TRAY WALL SUPPORT BRACKET

Part code	Description
X-BTWB-150	Basket tray wall support bracket - 150mm
X-BTWB-200	Basket tray wall support bracket - 200mm
X-BTWB-300	Basket tray wall support bracket - 300mm
X-BTWB-400	Basket tray wall support bracket - 400mm



BASKET TRAY CEILING BRACKET

Part code	Description
X-BTCB-150	Basket tray ceiling bracket - 150mm
X-BTCB-200	Basket tray ceiling bracket - 200mm
X-BTCB-300	Basket tray ceiling bracket - 300mm



BASKET TRAY ACCESSORIES

Part code	Description
X-BTC	Basket tray couplers - pair
X-BT-CH	Basket tray central support hangers - pair
X-BT-HDC	Basket tray hold down clamp
X-BTJ	Basket tray jointing kit - 4 part kit
X-BT-SH	Basket tray suspension hanger
X-BT-PC	Basket clamping piece - pack of 50
X-BT-FC	Basket corner connector

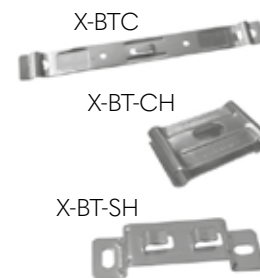

PENNY WASHERS



Part code M6	Part code M8	Part code M10	Part code M12	Description	Quantity
X-WA6-25-B25	X-WAS-25-B25	X-WA10-25-B25	X-WA12-25-B25	Penny Washer 25mm	Bag of 25
X-WA6-25-B100	X-WAS-25-B100	X-WA10-25-B100	X-WA12-25-B100	Penny Washer 25mm	Box of 100
X-WA6-30-B100	X-WAB-30-B100	X-WA10-30-B100	X-WA12-30-B100	Penny Washer 30mm	Box of 100
X-WA6-40-B100	X-WAB-40-B100	X-WA10-40-B100	X-WA12-40-B100	Penny Washer 40mm	Box of 100

FLAT / FORM A WASHERS



Part code M6	Part code M8	Part code M10	Part code M12	Description	Quantity
X-WA-M6-B100	X-WA-M8-B100	X-WA-M10-B100	X-WA-M12-B100	Flat / form A washer	Box of 100

SHAKE PROOF WASHERS



Part code M6	Part code M8	Part code M10	Part code M12	Description	Quantity
X-SPW-M6-B100	X-SPW-M8-B100	X-SPW-M10-B100	X-SPW-M12-B100	Shake proof washer	Box of 100

SQUARE PLATE WASHERS



Part code M6	Part code M8	Part code M10	Part code M12	Description	Quantity
X-SQPW-M6-B6	X-SQPW-M8-B6	X-SQPW-M10-B6	X-SQPW-M12-B6	Square plate washer	Bag of 6
X-SQPW-M6-B100	X-SQPW-M8-B100	X-SQPW-M10-B100	X-SQPW-M12-B100	Square plate washer	Box of 100

NUTS



X-CNLS-MB

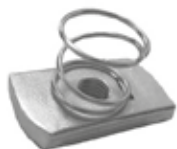

X-CNSS-MB



X-CN-MB



X-HN-MB



X-WN-MB



X-RBN-M6-16

LONG SPRING CHANNEL NUTS

Part code M6	Part code M8	Part code M10	Part code M12	Description	Quantity
X-CNLS-M6-B6	X-CNLS-M8-B6	X-CNLS-M10-B6	X-CNLS-M12-B6	Long spring channel nut	Bag of 6
X-CNLS-M6-B100	X-CNLS-M8-B100	X-CNLS-M10-B100	X-CNLS-M12-B100	Long spring channel nut	Box of 100

SHORT SPRING CHANNEL NUTS

Part code M6	Part code M8	Part code M10	Part code M12	Description	Quantity
X-CNSS-M6-B6	X-CNSS-M8-B6	X-CNSS-M10-B6	X-CNSS-M12-B6	Long spring channel nut	Bag of 6
X-CNSS-M6-B100	X-CNSS-M8-B100	X-CNSS-M10-B100	X-CNSS-M12-B100	Long spring channel nut	Box of 100

PLAIN CHANNEL NUTS

Part code M6	Part code M8	Part code M10	Part code M12	Description	Quantity
X-CN-M6-B8	X-CN-M8-B8	X-CN-M10-B8	X-CN-M12-B8	Plain channel nut	Bag of 8
X-CN-M6-B100	X-CN-M8-B100	X-CN-M10-B100	X-CN-M12-B100	Plain channel nut	Box of 100

HEXAGONAL NUTS AND COVER

Part code M6	Part code M8	Part code M10	Part code M12	Description	Quantity
X-HN-M6-B25	X-HN-M8-B25	X-HN-M10-B25	X-HN-M12-B25	Hexagonal nut	Bag of 25
X-HN-M6-B100	X-HN-M8-B100	X-HN-M10-B100	X-HN-M12-B100	Hexagonal nut	Box of 100
	X-HNC-M8-B100	X-HNC-M10-B100		Hexagonal nut cover	Bag of 10

WEDGE NUTS

Part code M6	Part code M8	Part code M10	Part code M12	Description	Quantity
X-WN-M6-B100	X-WN-M8-B100	X-WN-M10-B100	X-WN-M12-B100	Wedge nuts	Box of 100

ROOFING NUTS AND BOLTS

Part code M6-12mm	Part code M8-16mm	Part code M10-20mm	Description	Quantity
X-RBN-M6-12-B20	X-RBN-M8-16-B20	X-RBN-M10-20-B20	Roofing nut and bolt	Bag of 20
X-RBN-M6-12-B100	X-RBN-M8-16-B100	X-RBN-M10-20-B100	Roofing nut and bolt	Box of 100

SCREWS



HEX SETS

Part code M6	Part code M8	Part code M10	Part code M12	Description	Quantity
			X-S512-25-B10	Hex Set 25mm	Bag of 10
			X-S512-25-B100	Hex Set 25mm	Box of 100
X-SS6-30-B10	X-SSB-30-B10	X-SS10-30-B10	X-S512-30-B10	Hex Set 30mm	Bag of 10
X-SS6-30-B100	X-SSB-30-B100	X-SS10-30-B100	X-S512-30-B100	Hex Set 30mm	Box of 100
		X-SS10-35-B10		Hex Set 35mm	Bag of 10
		X-SS10-35-B100		Hex Set 35mm	Box of 100
	X-SSB-40-B10		X-SS12-40-B10	Hex Set 40mm	Bag of 10
	X-SSB-40-B100	X-SS10-40-B100	X-SS12-40-B100	Hex Set 40mm	Box of 100
	X-SSB-50-B10	X-SS10-50-B10		Hex Set 50mm	Bag of 10
	X-SSB-50-B100	X-SS10-50-B100		Hex Set 50mm	Box of 100

COACH SCREWS

Part code M8	Part code M10	Description	Quantity
X-CS-M830-B5	X-CS-M1030-B5	Coach screw 30mm	Bag of 5
X-CS-M830-B100	X-CS-M1030-B100	Coach screw 30mm	Box of 100
X-CS-M850-B5	X-CS-M1050-B5	Coach screw 50mm	Bag of 5
X-CS-M850-B100	X-CS-M1050-B100	Coach screw 50mm	Box of 100

TWIN FAST SCREWS

Part code 1"	Part code 1-1/2"	Part code 2"	Part code 2-1/2"	Description	Quantity
X-TF8-1	X-TF8-1-1/2	X-TF8-2		Twin fast screw size 8	Box of 200
X-TF10-1	X-TF10-1-1/2	X-TF10-2	X-TF10-2-1/2	Twin fast screw size 10	Box of 200

TEK SCREWS

Part code	Description	Quantity
X-TEK5.5-25-B100	TEK Screw 5.5 x 25mm	Box of 100
X-TEK5.5-38-B100	TEK Screw 5.5 x 38mm	Box of 100
X-TEK-MAGBIT	5/16 magentic socket adaptor	

PLASTER BOARD SCREWS

Part code	Description	Quantity
X-PBS	Plaster board screw 15mm	Box of 100

STUD CONNECTORS

Part code M8	Part code M10	Description	Quantity
X-SCON-M8-B4	X-SCON-M10-B4	Stud connector	Bag of 4
X-SCON-M8-B100	X-SCON-M10-B100	Stud connector	Box of 100

WALL PLUGS

Part code	Description	Quantity
X-WPR-5MM	Wall plug 5mm - red	Box of 100
X-WPB-7MM	Wall plug 7mm - brown	Box of 100
X-WPG-8/10MM	Wall plug 8/10mm - grey	Box of 25

ANCHOR BOLTS

Part code	Description	Quantity
X-AB-8/10-100-B4	Anchor Bolt 8mm 0-100	Bag of 4
X-AB-MI 0-B100	Anchor Bolt 8mm 0-100	Box of 100
X-AB-MI 0-60-B4	Anchor Bolt 8mm 0-60	Bag of 4
X-AB-MI 0-60-B100	Anchor Bolt 8mm 0-60	Box of 100



LOOSE BOLT SHIELD ANCHOR

Part code	Description	Quantity
X-LBSA-0810L	Loose Bolt Shield Anchor - 0810L	Box of 50
X-LBSA-1010L	Loose Bolt Shield Anchor -1010L	Box of 50
X-LBSA-1025L	Loose Bolt Shield Anchor -1025L	Box of 50



EYE BOLT

Part code	Description	Quantity
X-EB-MB-B25	Eye Bolt - MB x 80mm	Box of 25
X-EB-MI 0-B10	Eye Bolt - MI 0x 80mm	Box of 10



SOCKET BOLTS

Screw anchor TSM 6x35 and 6x55 by M8/M10 (countersunk head with metric internal thread), for fastening pipelines, ceiling brackets, ventilation ducts and timber substructures.



Part code	Description	Quantity
X-SB810-B4	Socket Bolt MB-MI 0	Box of 50
X-SBB10-B100	Socket Bolt MB-MI 0	Box of 50
X-SBL2810-B100	Socket Bolt Loose M8-MI 0 (2 Piece)	Box of 50
X-SBL810-B4	Socket Bolt Loose MB-MI 0 (3 Piece)	Box of 50
X-SBL810-B100	Socket Bolt Loose MB-MI 0 (3 Piece)	Box of 50

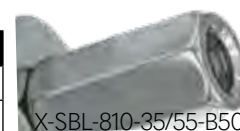

Part code	Description	Quantity
X-SBL-810-35-B50	Socket bolt loose M8-M10 (3 piece) 35mm	Box of 50
X-SBL-810-55-B50	Socket bolt loose M8-M10 (3 piece) 55mm	Box of 50

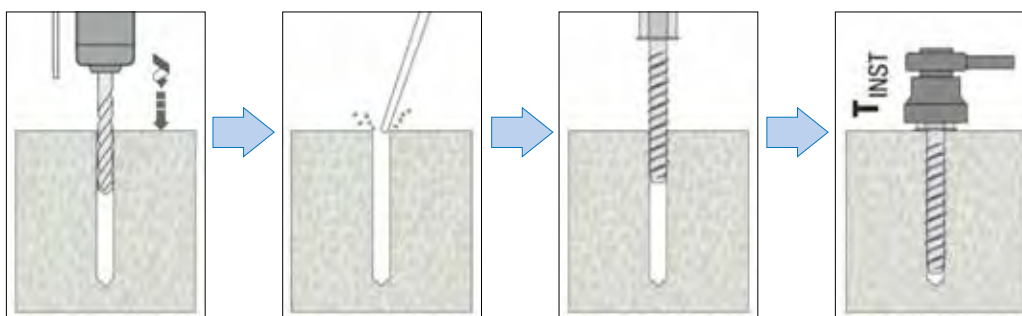

DRILL CORRECT DIAMETER HOLE TO CORRESPONDING DEPTH

CLEAN HOLE BY BLOWING TO REMOVE DRILLING DEBRIS AND DUST

INSERT ANCHOR INTO CONCRETE USING SUITABLE IMPACT WRENCH

TIGHTEN WITH TORQUE WRENCH TO RECOMMENDED TORQUE

DROP IN ANCHOR

X-DIA-M10



X-DIAL-M10 (LIPPED)



Part code M8	Part code M10	Part code M12	Description	Quantity
X-DIA-M8-B10	X-DIA-M10-B10	X-DIA-M12-B10	Drop In Anchor	Bag of 10
X-DIA-M8-B100	X-DIA-M10-B50	X-DIA-M12-B50	Drop In Anchor	MB Box of 100 - M10/M12 Box of 50
X-DIAL-M8-B100	X-DIAL-M10-B50	X-DIAL-M12-B50	Drop In Anchor Lipped	MB Box of 100 - M10/M12 Box of 50
X-DIA-ST			Drop In Anchor Setting Tool	Singles

CLAMPS AND CLIPS

**UNLINED M8-M10
PIPE CLAMPS**



Part code	Description	Quantity
X-PCU-15-18	Pipe clamp unlined - 15-18mm	Pack of 50
X-PCU-20-25	Pipe clamp unlined - 20-25mm	Pack of 50
X-PCU-26-30	Pipe clamp unlined - 26-30mm	Pack of 50
X-PCU-32-36	Pipe clamp unlined - 32-36mm	Pack of 50
X-PCU-38-43	Pipe clamp unlined - 38-43mm	Pack of 50
X-PCU-44-49	Pipe clamp unlined - 44-49mm	Pack of 50
X-PCU-56-61	Pipe clamp unlined - 56-61mm	Pack of 50
X-PCU-75-80	Pipe clamp unlined - 75-80mm	Pack of 50
X-PCU-87-92	Pipe clamp unlined - 87-92mm	Pack of 50
X-PCU-108-116	Pipe clamp unlined - 108-116mm	Pack of 25

CLAMPS AND CLIPS

BACK PLATE 810-HD

Back plate for mounting M8/M10 threaded rod. Secure threaded rod to a wall or ceiling safely.

Our Back Plate is used for Mounting M8 / M10 Threaded Rod safely to a wall or ceiling. Made from zinc plated steel, this back plate has a thickness of 3mm and comes in a box of 50.



Part code	Description	Material	Length	Width	Quantity
BackPlate-810-HD	Back Plate for Mounting M8/M10 Threaded Rod	2.5mm Zinc Plated Steel	80	30	50

RUBBER-LINED UNIVERSAL PIPE CLAMP

The M8-M10 rubber-lined pipe clamp are suitable for supporting all types of pipework including HVAC, boiler and drain. They come with noise suppressing rubber strips: 17dB(A) according to ISO 3822-1.



Part code	Description	Quantity
RLC-015	Pipe Clamp M8-10 Rubber lined 1/4" 11/15mm	Box of 50
RLC-020	Pipe Clamp M8-10 lined 3/8" 14-19mm	Box of 50
RLC-024	Pipe Clamp M8-10 lined 1/2" 20-24mm	Box of 50
RLC-029	Pipe Clamp M8-10 lined 3/4" 25-29mm	Box of 50
RLC-035	Pipe Clamp M8-10 lined 1" 32-36mm	Box of 50
RLC-044	Pipe Clamp M8-10 lined 1-1/4" 37-44mm	Box of 50
RLC-050	Pipe Clamp M8-10 lined 1-1/2" 44-50mm	Box of 50
RLC-058	Pipe Clamp M8-10 lined 50-58mm	Box of 50
RLC-068	Pipe Clamp M8-10 lined 2" 58-68mm	Box of 50
RLC-078	Pipe Clamp M8-10 lined 2-1/2" 68-78mm	Box of 50
RLC-088	Pipe Clamp M8-10 lined 78-88mm	Box of 50
RLC-098	Pipe Clamp M8-10 lined 3" 88-98mm	Box of 25
RLC-108	Pipe Clamp M8-10 lined 3-1/2" 98-108mm	Box of 25
RLC-118	Pipe Clamp M8-10 lined 4" 108-118mm	Box of 25
RLC-128	Pipe Clamp M8-10 lined 118-128mm	Box of 25
RLC-138	Pipe Clamp M8-10 lined 128-138mm	Box of 25
RLC-148	Pipe Clamp M8-10 lined 135-148mm	Box of 25
RLC-164	Pipe Clamp M8-10 lined 151-164mm	Box of 25
RLC-175	Pipe Clamp M8-10 lined 6" 165-175mm	Box of 10
RLC-185	Pipe Clamp M8-10 lined 175-185mm	Box of 10
RLC-205	Pipe Clamp M8-10 lined 194-205mm	Box of 10

HINGED LINED PIPE CLAMP

These hinged lined pipe clamps are suitable for supporting all types of pipe work including HVAC, boiler and drain. They come with noise suppressing rubber strips: 17dB(A) according to ISO 3822-1.



Part code	Description	Quantity
RLC-020-GS	Single Hinged Pipe Clamp M8-10 lined 3/8" 15-19mm	Box of 50
RLC-024-GS	Single Hinged Pipe Clamp M8-10 lined 1/2" 20-24mm	Box of 50
RLC-029-GS	Single Hinged Pipe Clamp M8-10 lined 3/4" 25-29mm	Box of 50
RLC-035-GS	Single Hinged Pipe Clamp M8-10 lined 1" 32-36mm	Box of 50
RLC-042-GS	Single Hinged Pipe Clamp M8-10 lined 1-1/4" 40-45mm	Box of 50
RLC-053-GS	Single Hinged Pipe Clamp M8-10 lined 1-1/2" 48-53mm	Box of 50
RLC-065-GS	Single Hinged Pipe Clamp M8-10 Lined 2" 58-63mm	Box of 50

K-KLAMP PIPE AND INSULATION CLAMP

K-KLAMP eliminates having to double-wrap, glue and tape the insulation on strut-mounted clamps. K-KLAMP pipe and insulation coupling reduces the time required to insulate copper tubing used for refrigerant lines. Our clamp allows sections of closed-cell insulation to be secured at fixing points.



Copper pipe I.D.	Insulation wall thickness			
	Part code 3/8"	Part code 1/2"	Part code 3/4"	Part code 1"
1/4"	K38-14	-	K34-14	-
3/8"	K38-38	K12-38	K34-38	-
1/2"	K38-12	K12-12	K34-12	K100-12
5/8"	K38-58	K12-58	K34-58	K100-58
3/4"	K38-34	K12-34	K34-34	K100-34
7/8"	K38-78	K12-78	K34-78	K100-78
1"	K38-100	K12-100	-	-
1-1/8"	K38-118	K12-118	K34-118	K100-118
1-3/8"	K38-138	K12-138	K34-138	K100-138
1-5/8"	K38-158	K12-158	K34-158	K100-158
2-1/8"	K38-218	K12-218	K34-218	K100-218
2-5/8"	-	K12-258	K34-258	K100-258
3-1/8"	-	K12-318	K34-318	K100-318
3-5/8"	-	K12-358	K34-358	K100-358
4-1/8"	-	K12-418	K34-418	K100-418

FUSED SPUR SWITCHES

Part code	Description
X-FSBBMC	Fused Spur Metal Clad - with Back Box
X-FSNBBMC	Fused Spur Metal Clad - with Back Box & Neon
X-FS	Fused Spur Plastic - without neon
X-FSN	Fused Spur Plastic - with neon
X-BBSM-25	Back Box Surface Mount - 25mm
X-BBSM-35	Back Box Surface Mount - 35mm
X-BBSM26-25	Back Box 2 Gang - 25mm
X-BBSM2G-35	Back Box 2 Gang - 35mm
X-BSPS-10A	Plug Socket - 10 Amp
X-2GSW2W-10A	Switch 2 Gang - 10 Amp
X-3GSW2W-10A	Switch 3 Gang - 10 Amp
X-1GDPSW-13A	Switch 1 Gang - 13 Amp
X-2GDPSW-13A	Switch 2 Gang - 13 Amp
X-DPSW-20A	Switch Double Pole - 20 Amp
X-PT	Plug Top - 13 Amp



FUSED SPUR METAL



FUSED SPUR PLASTIC

ROTARY ENCLOSED ISOLATORS

Our insulated 3 and 4-pole rotary enclosed isolators are CE marked and suitable for disconnecting the power supply to outdoor air conditioning units. The isolators are weatherproof to IP65, easy-to-install, and conform to IEC 60947-3. They have a lockable OFF position and interlocking cover which can be removed only in the OFF position. Earth and neutral terminals included and M20/25 knockouts up to 63A.



Part code	No of poles	AMPS AC21	AC23 A 240VA	AC23 A 400VA	Cable capacity		Height	Width	Depth
					Solid	Stranded			
IS-3P-20A-S	3	20amp	5.5kW	3.7kW	1-16mm ²	0.75-10mm ²	125mm	100mm	120mm
IS-3P-32A-S	3	32 amp	11kW	7.5kW	1-16mm ²	0.75-10mm ²	125mm	100mm	120mm
IS-3P-20A	3	20amp	5.5kW	3.7kW	1-16mm ²	0.75-10mm ²	175mm	114mm	135mm
IS-3P-32A	3	30amp	11kW	7.5kW	1-16mm ²	0.75-10mm ²	175mm	114mm	135mm
IS-3P-40A	3	40amp	15kW	11kW	1-16mm ²	0.75-10mm ²	175mm	114mm	135mm
IS-3P-63A	3	63amp	22kW	18.5kW	1-16mm ²	0.75-10mm ²	175mm	114mm	135mm
IS-4P-20A-S	4	20amp	5.5kW	3.7kW	1-16mm ²	0.75-10mm ²	125mm	100mm	120mm
IS-4P-32A-S	4	32 amp	11kW	7.5kW	1-16mm ²	0.75-10mm ²	125mm	100mm	120mm
IS-4P-20A	4	20amp	5.5kW	3.7kW	1-16mm ²	0.75-10mm ²	175mm	114mm	135mm
IS-4P-32A	4	32amp	11kW	7.5kW	1-16mm ²	0.75-10mm ²	175mm	114mm	135mm
IS-4P-40A	4	40amp	15kW	11kW	1-16mm ²	0.75-10mm ²	175mm	114mm	135mm
IS-4P-63A	4	63amp	22kW	18.5kW	1-16mm ²	0.75-10mm ²	175mm	114mm	135mm

STUFFING GLANDS

Part code black	Part code white	Description	Quantity
X-CSG-20B-B10	X-CSG-20W-B10	Cable Stuffing Gland - 20mm	Pack of 10
X-CSG-25B-B10	X-CSG-25W-B10	Cable Stuffing Gland - 25mm	Pack of 10



CABLES

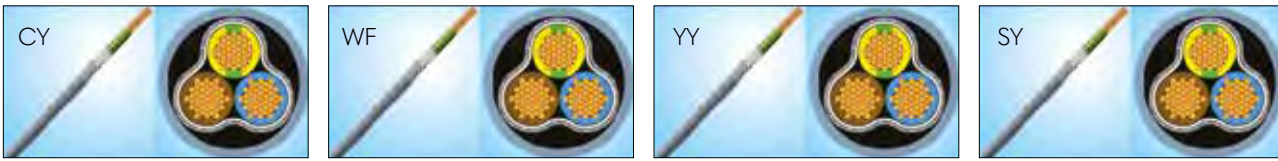

Part code CY	Part code WF	Part code YY	Part code SY	Description	Length
.75-2C-100				Cable 2 Core 0.75mm	100m
X-CY0.75C-2C-50	X-WF0.75-2C-50			Cable 2 Core 0.75mm	50m
X-CY1-2C-100	X-WF1-2C-100			Cable 2 Core 1mm	100m
X-CY1-2C-50	X-WF1-2C-50			Cable 2 Core 1mm	50m
X-CY1.5-2C-100		X-YY1.5-2C-100		Cable 2 Core 1.5mm	100m
X-CY1.5-2C-50				Cable 2 Core 1.5mm	50m
	X-WF0.75-3C-50			Cable 3 Core 0.75mm	50m
	X-WF1-3C-50			Cable 3 Core 1mm	50m
			X-SY1.5-3C-100	Cable 3 Core 1.5mm	100m
	X-WF1.5-3C-50			Cable 3 Core 1.5mm	50m
		X-YY2.5-3C-100	X-SY2.5-3C-100	Cable 3 Core 2.5mm	100m
	X-WF2.5-3C-50		X-SY2.5-3C-50	Cable 3 Core 2.5mm	50m
		X-YY0.75-4C-100		Cable 4 Core 0.75mm	100m
		X-YY0.75-4C-50		Cable 4 Core 0.75mm	50m
			X-SY1-4C-100	Cable 4 Core 1mm	100m
		X-YY1.5-4C-100	X-SY1.5-4C-100	Cable 4 Core 1.5mm	100m
		X-YY1.5-4C-50	X-SY1.5-4C-50	Cable 4 Core 1.5mm	50m
		X-YY2.5-4C-100	X-SY2.5-4C-100	Cable 4 Core 2.5mm	100m
		X-YY2.5-4C-50		Cable 4 Core 2.5mm	50m
			X-SY1.5-5C-100	Cable 5 Core 1.5mm	100m
			X-SY1.5-5C-50	Cable 5 Core 1.5mm	50m
			X-SY2.5-5C-100	Cable 5 Core 2.5mm	100m
			X-SY2.5-5C-50	Cable 5 Core 2.5mm	50m
		X-YY1.5-7C-100		Cable 7 Core 1.5mm	100m
		X-YY1.5-7C-50		Cable 7 Core 1.5mm	50m

CABLE TIES / CABLE TIE MOUNTS

Part code	Description	Quantity
X-CT100-2.5B-B100	Cable Tie 100mm x 2.52mm - Black	Pack of 100
X-CT300-4.8B-B100	Cable Tie 300mm x 4.8mm - Black	Pack of 100
X-CT300-4.8W-B100	Cable Tie 300mm x 4.8mm - White	Pack of 100
X-CT300-7.6B-B100	Cable Tie 300mm x 7.6mm - Black	Pack of 100
X-CT480-13B-B100	Cable Tie 480mm x 13mm - Black	Pack of 100
X-CT730-13B-B100	Cable Tie 730mm x 13mm - Black	Pack of 100
ID-BT-250	Cable Tie 250mm x 20mm - Ivory	Pack of 20
ID-BT-350	Cable Tie 350mm x 20mm - Ivory	Pack of 20
X-CB28-BL-B100	Cable Tie Base - 28mm Self Adhesive - Black	Pack of 100
X-CB28-W-B100	Cable Tie Base - 28mm Self Adhesive - White	Pack of 100

Part code	Description	Quantity
CTM-1	Cable Tie Mount - Screw Fixing	Pack of 100
CTM-2	Cable Tie Mount - with Studding	Pack of 100





FLEXI SUPPORT SYSTEMS

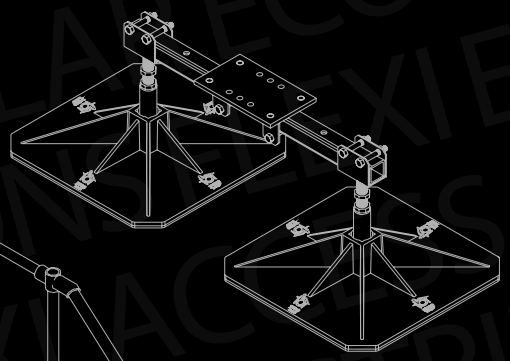

EVERYDAY

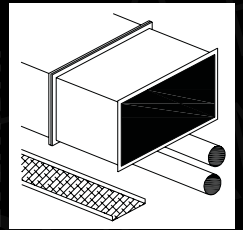

ACCESS

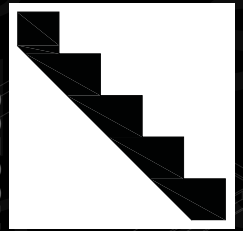

HEAVY

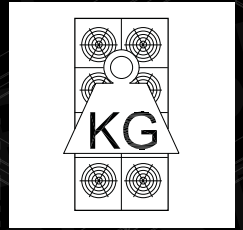

LIGHT

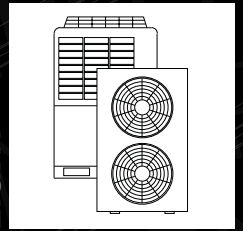

SOLAR

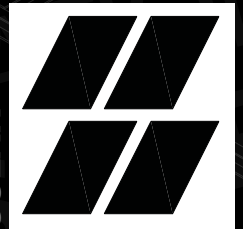

FLEXI RANGE
PAGE 107

sales@flexisupportsystems.com
www.flexisupportsystems.co.uk

OIL & LUBRICANT



VACUUM PUMP OIL



ROBINAIR PREMIUM HIGH VACUUM PUMP OIL

- Mineral oil
- Chemically engineered to maintain maximum viscosity at high running temperatures and to improve cold weather starts
- Thermal stability – resists break-down due to heat
- Lower moisture content – due to special packaging and handling procedures
- Performance of your pump depends largely on the quality and purity of the vacuum pump oil that you use



Part code	Description	Quantity
RA-13119	Premium High Vacuum Pump Oil, 0.475 Litres (16oz)	12
RA-13119	Premium High Vacuum Pump Oil, 0.95 Litres (32oz)	12
RA-13204	Premium High Vacuum Pump Oil, 3.8 Litres (128.5oz)	4

SYNTHETIC REFRIGERATION OIL



Part code	Description	Size
601231292	Fuchs Reniso Triton SEZ 22	5 L
600669812	Fuchs Renison Triton SEZ 32	1L
601231339	Fuchs Reniso Triton SEZ 32	5L
600646509	Fuchs Reniso Triton SE55	1L
601231414	Fuchs Reniso Triton SE 55	5 L
600680107	Fuchs Reniso Triton SEZ 68	1L
601231254	Fuchs Renison Triton SEZ 68	5L
601231278	Fuchs Reniso Triton SE 170	5L
600680442	Fuchs Reniso Triton SE 170	10L
600756512	Fuchs Reniso PAG 100	1L
600741105	Fuchs Reniso C85 E	1L
600360382	Fuchs Reniso C85 E	10L

RENISO C 85 E

SYNTHETIC REFRIGERATION OIL FOR CO₂ COMPRESSORS

Description

RENISO C 85 E is a special synthetic refrigeration oil based on synthetic esters. Selected additives guarantee excellent wear protection, also under the influence of CO₂ in the compressor. RENISO C 85 E has an excellent solubility / miscibility with the refrigerant carbon dioxide (R 744).

Application

RENISO C 85 E was developed for use mainly in refrigeration systems (deep-temperature systems, cascades, etc.) which are working with the refrigerant CO₂ (R 744). RENISO C 85 E has an excellent solubility / miscibility with CO₂ which guarantees the oil circulation in the refrigeration system, especially at low evaporation temperatures. RENISO C 85 E can be used in almost any application in industrial and commercial refrigeration, e.g. large-scale cooling plants. RENISO C 85 E can also be used in transcritical CO₂ cycles, e.g. air conditioning and heat pump systems, as well as container cooling systems.

Specifications

RENISO C 85 E is a refrigeration oil acc. to DIN 51503: KB – refrigeration oils for CO₂.

NSF H2 registration:
registration no. 146755

Advantages

- **High thermal stability**
 - **High chemical stability with CO₂ refrigerant**
 - **Excellent miscibility with CO₂ – also at low temperatures**
 - **Excellent deep-temperature flowability**
 - **Excellent lubrication at high pressure levels under CO₂ atmosphere**
 - **Excellent experience in test facilities and prototype systems**
 - **Used by leading compressor manufacturers.**
- Approvals:**

DORIN
GEA BOCK
GEA GRASSO
JOHNSON CONTROLS INTERNATIONAL



Properties	Unit		Test Method
Colour		0.5	DIN ISO 2049
Density at 15 °C	kg/m ³	993	DIN 51757
Flashpoint	°C	246	DIN ISO 2592
Kinematic viscosity at 40 °C	mm ² /s	80	DIN EN ISO 3104
at 100 °C	mm ² /s	10.6	
Viscosity index	-	118	DIN ISO 2909
Pourpoint	°C	- 42	DIN ISO 3016
Neutralisation number	mgKOH/g	0.03	DIN 51558-1
Water content	mg/kg	< 30	DIN 51777-2

RENISO TRITON SE/SEZ

SYNTHETIC REFRIGERATION OILS BASED ON POLYOL ESTERS (POE)
FOR HFC/FC REFRIGERANTS

Description

The refrigeration oils of the RENISO TRITON SE/SEZ series are based on synthetic esters that were especially developed for use with chlorine-free, fluorinated hydrocarbons (HFC/FC). In contrast to conventional refrigeration oils, these are miscible and compatible with polar HFC/FC.

Application

The RENISO TRITON SE/SEZ series is outstandingly suited for all refrigeration circuits, in which chlorine-free HFC/FC refrigerants, e.g. R134a, R404A or R410A are used. Depending on the viscosity, RENISO TRITON SE/SEZ refrigeration oils are recommended for hermetical, semi-hermetical and open piston compressors and for screw-type and turbo-compressors. RENISO TRITON SEZ 22 is especially suitable for deep-freeze systems operating with R23.

RENISO TRITON SE/SEZ products are also suitable for hydrocarbon refrigerants (e.g. propane, polypropylene, isobutane) and R22. In such cases please contact FUCHS prior to the usage.

Specifications

RENISO TRITON SE/SEZ lubricants fulfill and exceed the requirements acc. to DIN 51503-1, Groups KC, KD, KE.

Advantages/ Benefits

- Special synthetic polyolester
- Stable lubrication film even at high temperatures, outstanding lubricity
- Excellent solubility with HFC and FC refrigerants
- Very high thermal and chemical stability in the presence of fluorinated refrigerants
- Good viscosity-temperature behavior
- Excellent cold temperature flowability
- Secure oil return from the system, good heat transfer
- Good compatibility with elastomers and materials normally used in refrigeration circuits
- Readily biodegradable (ISO VG 32 and ISO VG 55)
- Approved by leading compressor manufacturers
- Ultra-dried



Product name	RENISO TRITON					
	SEZ 22	SEZ 32	SE 55	SEZ 68		
Properties	Unit					Test method
Density at 15 °C	kg/m ³	1003	1004	1009	970	DIN 51757
Flash point	°C	248	250	286	258	DIN ISO 2592
Color	-	0	0.5	1.0	0.5	DIN ISO 2049
Kinematic viscosity at 40 °C	mm ² /s	20	32	55	68	DIN EN ISO 3104
at 100 °C	mm ² /s	4.4	6.1	8.8	8.9	
Viscosity index	-	133	141	137	104	DIN ISO 2909
Pourpoint	°C	-57	-57	-48	-39	DIN ISO 3016
Neutralization number	mgKOH/g	0.03	0.03	0.03	0.03	DIN 51558-1
Water content	mg/kg	< 50	< 50	< 50	< 50	DIN 51777-2

RENISO PAG 46 AND RENISO PAG 100

FULLY SYNTHETIC REFRIGERATION OILS BASED ON SPECIAL POLYGLYCOLS (PAG) FOR R134A AC SYSTEMS

Description

Because of their Cl content, CFC refrigerants like R12 destroy the earth's ozone layer. This led all manufacturers to cease production of fully halogenized CFC's and introduce alternative products. This move is a reaction to the ban on CFC's and halons which established a timetable for the progressive ending of CFC production and use. Alternative refrigerants such as R134a have found general acceptance and are currently in use.

As classic refrigeration oils based on mineral oils, polyalphaolefins and alkylbenzene oils are not miscible with R134a, new refrigeration oils had to be developed, RENISO PAG-Series.

Application

Most car and truck air conditioning systems use Japanese- or American-made compressors and R134a refrigerants. These compressors require the use of synthetic, polyglycol-based refrigeration oils such as RENISO PAG 46 or RENISO PAG 100. The RENISO PAG products have an excellent miscibility and compatibility with R134a.

RENISO PAG 46 and RENISO PAG 100 are based on polar polyglycols. The structure of polyglycols make them hygroscopic (= absorb moisture). This means that special care must be taken when handling such products (always keep containers tightly sealed, use nitrogen to cover the refrigeration oil and store drums in dry, air conditioned rooms).

Advantages

- Very high thermal stability
- Excellent miscibility and compatibility with R134a refrigerants (substitute for R12 refrigerants)
- Excellent viscosity-temperature behaviour (high VI)
- Low viscosity at low temperature, good flowability
- Stable lubricating film at high temperatures
- Good compatibility with all materials commonly used in refrigeration systems
- RENISO PAG 46 and RENISO PAG 100 are ultra-dried



Product name		PAG 46	PAG 100	
Refrigeration oil type acc. to DIN 51503-1		KD	KD	
Characteristics	Unit			Test method
Colour		colourless	colourless	Visual
Kinematic viscosity	at 40 °C	55	120	DIN EN ISO 3104
	at 100 °C	10.6	21	
Viscosity index		187	202	DIN ISO 2909
Density at 15 °C	kg/m ³	992	996	DIN 51757
Flashpoint, Cleveland open cup	°C	240	240	DIN ISO 2592
Pourpoint	°C	- 45	- 45	DIN ISO 3016
Neutralisation number	mgKOH/g	0.04	0.04	DIN 51558-1
Water content	ppm	300	300	DIN 51777-2
Stability with R134a, 175 °C / 14 days	--	pass	pass	ASHRAE 97-89

	FUCHS oil	Competitor equivalent	Refrigerants	Approvals
MINERAL OILS	<ul style="list-style-type: none"> • RENISO KM 32 • RENISO KS 46 • RENISO KC 68 • RENISO KES 100 	-	<ul style="list-style-type: none"> • For NH3 and R22 	-
	<ul style="list-style-type: none"> • RENISO WF 5 A • RENISO WF 7 A • RENISO WF 10 A • RENISO WF 15 A 	-	<ul style="list-style-type: none"> • For hydrocarbons (e.g. R600a - hermetic compressors) 	-

SYNTHETIC HYDROCARBON OIL	<ul style="list-style-type: none"> • RENISO ULTRACOOOL 68 • RENISO ULTRACOOOL 100 	<ul style="list-style-type: none"> • PETROCANADA REFLO 68 • KLUBER RHT 68 • CPI 1009 68 • MOBIL GARGOYLE ARCTIC SHC NH 68 226E • TEXACO CAPELLA P68 • TOTAL LUNARIA NH 68 	<ul style="list-style-type: none"> • NH3 (Ammonia) 	NSF H1 registered
---------------------------	---	---	---	-------------------

POLYALPHAOLEPHINS (PAO) OILS	<ul style="list-style-type: none"> • RENISO SYNTH 68 	<ul style="list-style-type: none"> • PETROCANADA REFLO 68 • KLUBER RHT 68 • CPI 1009 68 • MOBIL GARGOYLE ARCTIC SHC NH 68 226E • TEXACO CAPELLA P68 • TOTAL LUNARIA NH 68 	<ul style="list-style-type: none"> • NH3 (Ammonia) 	NSF H1 registered
------------------------------	---	---	---	-------------------

POLYALKYLENEGLYCOL (PAG) OIL	<ul style="list-style-type: none"> • RENISO PG68 	-	<ul style="list-style-type: none"> • AMMONIA AND HYDROCARBONS 	-
	<ul style="list-style-type: none"> • RENISO LPG 68 	-	<ul style="list-style-type: none"> • HYDROCARBONS, e.g. R290, R1270, R600a 	-

ALKYLBENZENES (AB)	<ul style="list-style-type: none"> • RENISO SP 32 • RENISO SP 46 • RENISO SP 100 • RENISO SP 220 	-	<ul style="list-style-type: none"> • R22 AND HYDROCARBONS 	-
	<ul style="list-style-type: none"> • RENISO S 3246 • RENISO S 68 	-	<ul style="list-style-type: none"> • R22, HYDROCARBONS AND AMMONIA 	-

	FUCHS oil	Competitor equivalent	Refrigerants	Approvals
POLYOLESTER (POE) OILS	<ul style="list-style-type: none"> • RENISO SEZ 22 • RENISO SEZ 32 • RENISO SEZ 55 • RENISO SEZ 68 • RENISO SEZ 80 F • RENISO SE 100/170/220 	<ul style="list-style-type: none"> • BITZER BSE 32 • CASTROL ICEMATIC SW22-32-46-68-80 • SOLTEST 22-32-46-68-80 • EMKARTE RL22H-32-46-68-80 • MOBIL EAL ARCTIC 22-32-46-68-80 • SHELL CLAVUS R22-32-46-68-80 • SUNISO SL 22-32-46-68-80 • TEXACO CAPELLO HFC 22-32-46-68-80 • TOTAL PLANET ELF ACD 22-32-46-68-80 • BITZER BSE 150 170 • CASTROL ICEMATIC SW100-170-220 • CPI SOLTEST 100-170-220 • EMKARTE RL100 H-170-220 • MOBIL EAL ARCTIC 100-170-220 • SHELL CLAVUS R100-170-220 • SUNISO SL 100-170-220 • TOTAL PLANET ELF ACD 100FY -150FY-220FY 	<ul style="list-style-type: none"> • Fully synthetic oil based on Polyol ester POE. Suitable for no ozone depleting FC/HFC refrigerants. RENISO TRITON SE/SEZ suitable for HFO and HFO/HFC refrigerants. Suitable with new refrigerants designed to replace R22 such as R422A/D and R417a 	<ul style="list-style-type: none"> • BITZER • BOCK • COPELAND (SEZ 32) • DANFOSS • FRIGOPOL • GRASSO (SCREW SEZ 68) • MCQUAY EUROPA • PRESTCOLD • ROTOCOLD • SABROE • SUTRAK • TRANE USA • ZANUSSI
	• RENISO TRITON SEZ 320	-	R22	-
	• RENISO SEZ 35 SC	-	HFC/FC	-

SPECIAL POLYOLESTER (POE) OIL	<ul style="list-style-type: none"> • RENISO C55 E • RENISO C85 E • RENISO C170 E 	-	<ul style="list-style-type: none"> • SUBCRITICAL CO2 • SUBCRITICAL/TRANSCRITICAL CO2 • SUBCRITICAL CO2 (screw compressor) 	<ul style="list-style-type: none"> • BITZER • DANFOSS • GEA BOCK • GRASSO • LINDE CARRIER • OBRIST • YORK
--------------------------------------	---	---	--	--

SPECIAL POLYALKALINE GLYCOL (PAG)	• RENISO ACC	-	• CO2 -AC CAR SYSTEMS	-
	• RENISO ACC 68 PAG	-	• CO2 -HEAT PUMPS/ CARS	-

SPECIAL POLYALKALINE GLYCOL (PAG) FOR MOBILE AC SYSTEMS	• RENISO PAG 46	-	• R134A, HYDROCARBONS, AMMONIA	-
	• RENISO PAG 100	-	• R1234YF, R134A MOBILE SYSTEMS	-
	• RENISO ACC HV	-	• CO2 MOBILE AC SYSTEMS	-

SPECIAL POE FOR MOBILE AC SYSTEMS - HYBRID AND ELECTRIC CARS	• RENISO TRITON SEZ 75 AC	-	• R1234YF, R134A, ELECTRIC COMPRESSORS	-
---	---------------------------	---	--	---

4 GOOD REASONS FOR USING RENISO REFRIGERATION OILS

Performance comparison RENISO TRITON SEZ 80 versus standard polyol ester (POE) refrigeration oils.

1 High thermo-chemical stability e.g. in Sealed Glass Tube Test (ASHRAE 97-2007)



Standard POE
refrigeration oils

High stability



RENISO TRITON SEZ 80

2 Very good miscibility with HFC/FC: e.g. in miscibility evaluation (DIN 51514)



Standard POE
refrigeration oils

Good miscibility

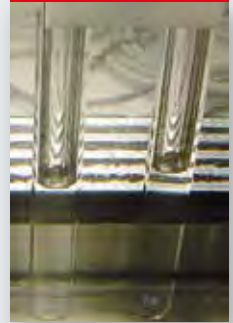

RENISO TRITON SEZ 80

3 Low varnish / low sludge formation e.g. in FUCHS In-house test (evaluation of oil sludge in beaker with bearing roller after 168h/135 °C)



Standard POE
refrigeration oils

No sludge



RENISO TRITON SEZ 80

4 Reliable wear protection e.g. in bearing wear testing (DIN 51819-3)



Standard POE
refrigeration oils

No wear



RENISO TRITON SEZ 80

TOOLS



hilmar® RANGE

PAGE 215



Quick-Engage Flare and Swage
1838947

RECOVERY MACHINES



RECOVERY MACHINES



BOSCH RG-4.0



REFRIGERANT RECOVERY MACHINE FROM BOSCH. EXTERNALLY CERTIFIED FOR A1, A2L AND A3 REFRIGERANTS WITH CONFIRMATION NO. 2018/SX/PV/222

- Recovers all commonly used CFC, HFC, HCFC Refrigerants
- Suitable for A2L Refrigerants such as R32 and R1234YF
- Suitable for A3 Refrigerants such as R290 and R600a
- Oil-less compressor suitable for liquid and vapor
- Fully automatic high & low pressure reset
- Available in 110V and 240V
- 1 year warranty



Technical information	
High Pressure Cut Out	550psi / 38.5 bar
Compressor	Single Cylinder 1/2 HP, 1700-1750 rpm (110V) 1/2 HP, 1400-1450 rpm (240V)
Approvals	CE, UL, ARI and TUV
Weight	14.6kg
Voltage	240V 50-60Hz 110V 50-60Hz
Refrigerant Examples	R1234YF, R134A, R22, R32, R290, R401B, R401C, R402A, R402B, R404A, R406A, R407A, R407B, R407C, R407D, R408A, R409A, R410A, R411A, R411B, R412A, R417A, R422A, R422D, R427A, R500, R502, R507, R509, R600a

Recovery Rates (Max Capacity)	
PUSH / PULL	6.84 Kg/min
	410.5 Kg/hr
Liquid	2.03 Kg/min
	122.1 Kg/hr
Vapour	0.17 Kg/min
	10.7 Kg/hr

Part code	Description	Quantity
BOSCH RG-4.0A	Bosch Recovery Unit - 240V 50-60Hz	1
BOSCH RG-4.0B	Bosch Recovery Unit - 110V 50-60Hz	1

EXPLODED DIAGRAM

CODE	No.	PRODUCT
-	1	Tube - Manifold to compressor inlet
-	2	Compressor
-	3	Start capacitor (only for 115 V)
-	4	Motor 230 V
-		Motor 115 V
-	5	Motor bracket 230 V
-		Motor bracket 115 V
-	6	LH enclosure
-	7	Knob - Main power switch
-	8	Pump bracket
-	9	Main power switch
-	10	Electrical fan 230 V
-		Electrical fan 115 V
-	11	Manifold assembly
-	A	Gauge - High pressure
-	B	Gauge - Low pressure
-		Circuit breaker 12 A, 115 V

CODE	No.	PRODUCT
-	C	Switch - High pressure
-	D	Switch - Low pressure
-	12	Grill - gray
-	13	Knob - Ball valve (Red)
-	14	Knob - Ball valve (Blue)
-	15	Knob - Ball valve (Black)
-	16	HMI cover
-	17	Front Panel
-	18	Condenser
-	19	RH Enclosure
-	20	Tube- Manifold to compressor outlet
-	21	Interface - Motor and compressor
-	22	Coupler
-	23	Circuit breaker 8 A, 230 V
-		Circuit breaker 12 A, 115 V

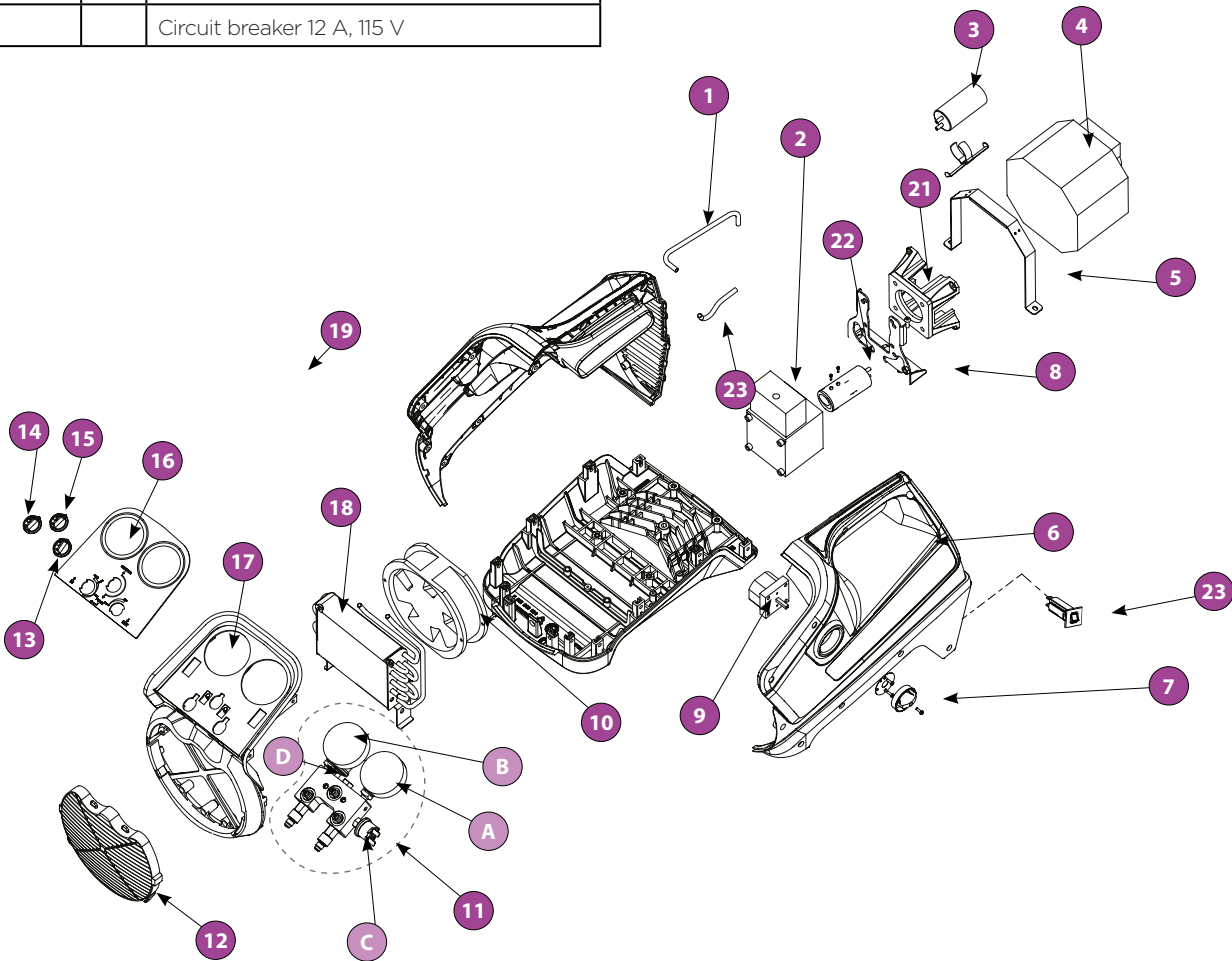

PROMAX RG 3000

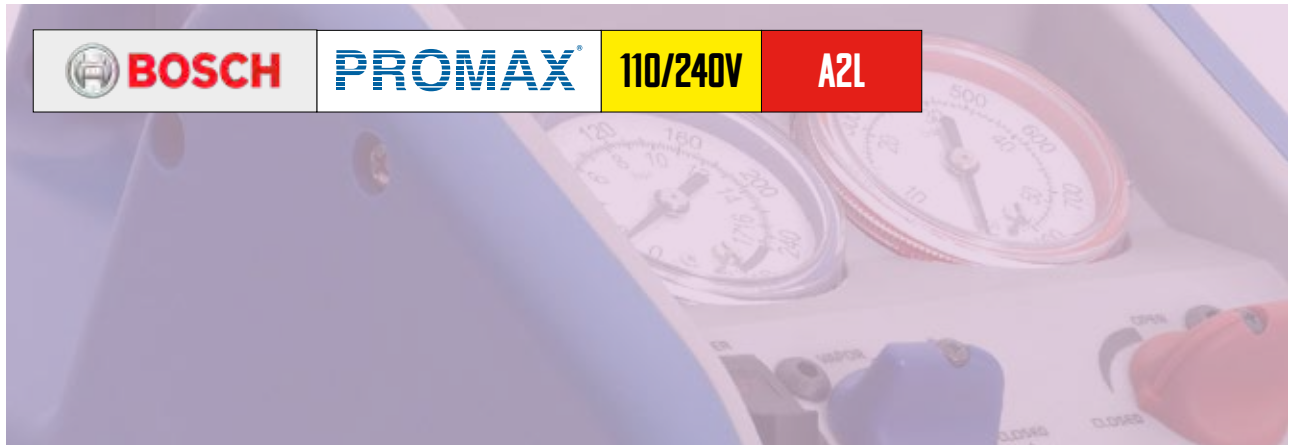

ULTRA COMPACT REFRIGERANT RECOVERY MACHINE FROM PROMAX

- Ultra compact and lightweight
- Our smallest, lightest recovery machine
- Recovers all commonly used CFC, HFC, HCFC Refrigerants
- Suitable for A2L Refrigerants such as R32 and R1234YF
- Oil-less compressor suitable for liquid and vapour
- Available in 110V and 240V
- 1 year warranty



Technical information	
High Pressure Cut Out	550psi / 38.5 bar
Compressor	Single Cylinder 1/3 HP, 1700-1750 rpm (110V) 1/3 HP, 1400-1450 rpm (240V)
Approvals	CE, UL, ARI and TUV
Weight	8kg
Voltage	240V 50-60Hz 110V 50-60Hz
Refrigerant Examples	R1234YF, R22, R32, R134A, R401B, R401C, R402A, R402B, R4040A, R406A, R407A, R407B, R407C, R407D, R408A, R409A, R410A, R411A, R411B, R412A, R417A, R422A, R422D, R427A, R500, R502, R507, R509 and others

Recovery Rates (Max Capacity)	
PUSH / PULL	3.8 Kg/min
	229.13 Kg/hr
Liquid	0.97 Kg/min
	58.25 Kg/hr
Vapour	0.136 Kg/min
	8.18 Kg/hr

Part code	Description	Quantity
RG 3000 E	RG 3000 E Promax Ultra Compact Recovery Unit - 240V 50Hz 1	1
RG 3000 110V	Promax Ultra Compact Recovery Unit - 110V 50Hz	1

EXPLODED DIAGRAM

CODE	No.	PRODUCT
-	1	RG3000 Condenser 105-201234-001
-	2	RG3000 Motor Clamp Left
-	3	RG3000 Motor Clamp Right
-	4	RG3000 110V Motor
-	4	RG3000 240V Motor
-	5	RG3000 Compressor
-	6	RG3000 Manifold Assy. Low Side
-	7	RG3000 Manifold Assy. High Side
-	8	RG3000 Power Switch

CODE	No.	PRODUCT
-	9	RG3000 Power Receptacle RS
-	10	RG3000 Fuse Holder
-		Fuse, slow blow 8amp
-	11	RG3000 110V Capacitor Motor Start
-	11	RG3000 240V Capacitor, Motor Start
-	12	RG3000 Fan 240
-	12	RG3000 Fan 110
-	13	RG3000 Coupler

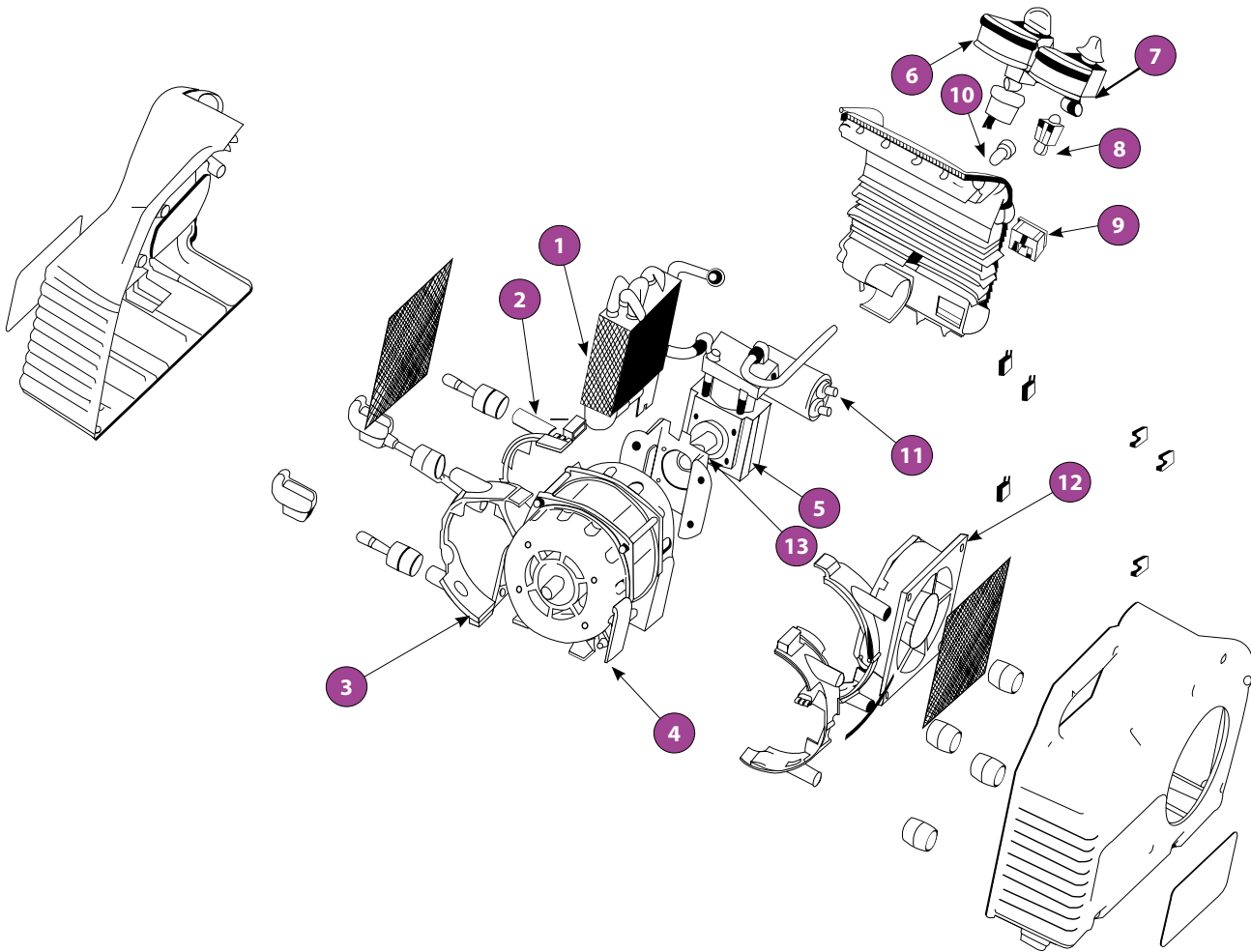

RECOVERY MACHINES



PROMAX MINIMAX



COMPACT REFRIGERANT RECOVERY MACHINE FROM PROMAX

- Minimum size, maximum performance
- Recovers all commonly used CFC, HFC, HCFC Refrigerants
- Suitable for A2L Refrigerants such as R32 and R1234YF
- Oil-less compressor suitable for liquid and vapour
- Manual high pressure reset switch
- Available in 110V and 240V
- 1 year warranty



Technical information	
High Pressure Cut Out	550psi / 38.5 bar
Compressor	Single Cylinder 1/3 HP, 1700-1750 rpm (110V) 1/3 HP, 1400-1450 rpm (240V)
Approvals	CE, UL, ARI and TUV
Weight	11kg
Voltage	240V 50-60Hz 110V 50-60Hz
Refrigerant Examples	R1234YF, R22, R32, R134A, R401B, R401C, R402A, R402B, R4040A, R406A, R407A, R407B, R407C, R407D, R408A, R409A, R410A, R411A, R411B, R412A, R417A, R422A, R422D, R427A, R500, R502, R507, R509 and others

Recovery Rates (Max Capacity)	
PUSH / PULL	5.9 Kg/min
	354 Kg/hr
Liquid	1.5 Kg/min
	90 Kg/hr
Vapour	0.15 Kg/min
	9 Kg/hr

Part code	Description	Quantity
MINIMAX	Promax Minimax Comp act R recovery U nit - 240V 50-60Hz	1
MINIMAX-E	Promax Minimax Comp act R ecovery Unit - 11 0V 50-60Hz	1

EXPLODED DIAGRAM

CODE	No.	PRODUCT
-	1	Bell Housing
-	2	Compressor Bracket
-	3	Bracket - Motor
-	4	Case
-	5	Capacitor
-	6	Coupler
-	7	Compressor
-	8	Condenser
-	9	Fan 110V
-	9	Fan 240V
-	10	Fan Screen - outlet
-	10	Fan Screen - inlet
-	11	Flare Fitting 45°
-	12	Fuse, slow blow 8amp
-	13	Gauge - Input LP (Blue) 500psi
-	14	Gauge - Output HP (Red) 800psi
-	15	Gauge Lens (2)
-	16	HP Switch Automatic

CODE	No.	PRODUCT
-	16	HP switch 240V
-	17	Inlet Hose 4"
-	18	Inlet Filter dryer (with hoses)
-	18	Inlet Filter dryer (without hoses)
-	19	Knob - Black
-	20	Knob - Blue
-	21	Knob - Red
-	22	Manifold
-		Manifold Valve Seal
-	23	Motor 115V/60Hz
-	23	Motor 230V/60Hz
-		Motor Clamp
-		Neoprene Ball 5/16" GRD 1 - manifold part
-	24	Power Cord 110V
-	24	Power Cord 240V
-		Rivnut 10-24
-	25	Switch -On/Off
-	26	Switch - Start

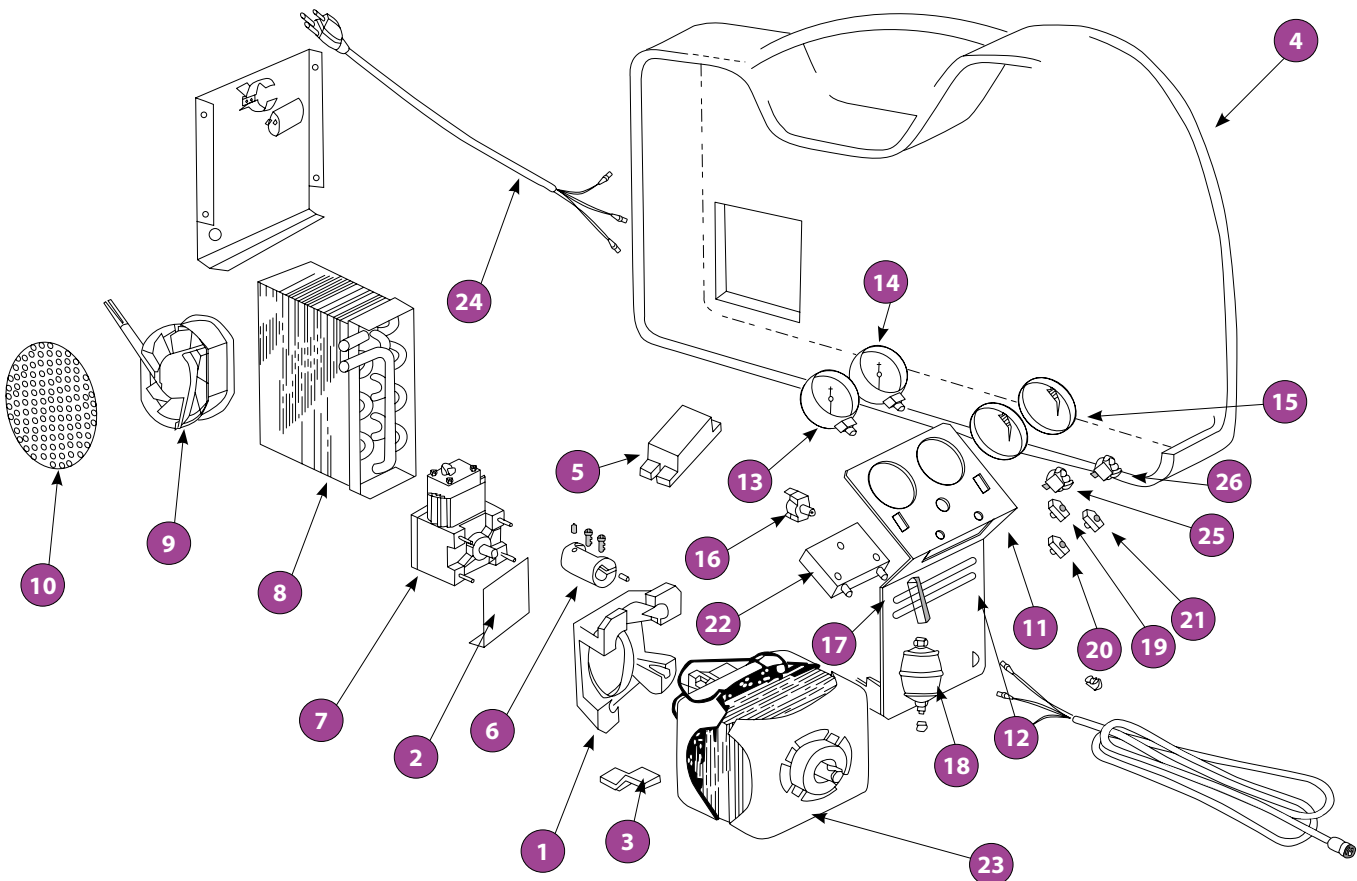

RECOVERY MACHINES



PROMAX RG 5410A



COMPACT REFRIGERANT RECOVERY MACHINE FROM PROMAX

- Recovers all commonly used CFC, HFC, HCFC Refrigerants
- Suitable for A2L Refrigerants such as R32 and R1234YF
- Oil-less compressor suitable for liquid and vapour
- Manual high pressure reset switch
- Selectable low pressure switch
- Available in 110V and 240V
- 1 year warranty



Technical information	
High Pressure Cut Out	550psi / 38.5 bar
Compressor	Single Cylinder 1/2 HP, 1700-1750 rpm (110V) 1/2 HP, 1400-1450 rpm (240V)
Approvals	CE, UL, ARI and TUV
Weight	13.5kg
Voltage	240V 50-60Hz 110V 50-60Hz
Refrigerant Examples	R1234YF, R22, R32, R134A, R401B, R401C, R402A, R402B, R4040A, R406A, R407A, R407B, R407C, R407D, R408A, R409A, R410A, R411A, R411B, R412A, R417A, R422A, R422D, R427A, R500, R502, R507, R509 and others

Recovery Rates (Max Capacity)	
PUSH / PULL	6.22 Kg/min
	373 Kg/hr
Liquid	1.85 Kg/min
	111 Kg/hr
Vapour	0.16 Kg/min
	9.6 Kg/hr

Part code	Description	Quantity
RG 5410A E240V	Promax Recovery Unit - 240V 50-60Hz	1
RG 5410A E	Promax Recovery Unit - 110V 50-60Hz	1

EXPLODED DIAGRAM

CODE	No.	PRODUCT
-	1	Bell Housing
-	2	Capacitor
-	2	Capacitor [EXTREME]
-	3	Check Valve [EXTREME]
-	4	Condenser
-	5	Compressor CP1320
-	6	Compressor Bracket
-	7	Coupler
-	7	Coupler [EXTREME]
-	8	Fan Assembly 110V
-	8	Fan Assembly 240V
-	9	Fan Grill
-	10	Flare Cap 1/4"
-	11	Flare Fitting 45°
-	12	Fuse, slow blow 8amp
-	13	Fuse Holder
-	14	Gauge - Input LP (blue)
-	14	Gauge - Input LP (blue) [EXTREME] 500psi
-	15	Gauge - Output HP (red)
-	15	Gauge - Output HP (red) [EXTREME]
-	16	Gauge Lens (2)
-	17	HP Switch

CODE	No.	PRODUCT
-	18	Inlet Filter dryer (with hose)
-	18	Inlet Filter dryer (without hose)
-	19	Inlet Hose 4"
-	20	Knob - Black
-	21	Knob - Blue
-	22	Knob - Red
-	23	Manifold
-		Manifold Valve Seal
-	24	Motor 110V
-	24	Motor 230V
-	24	Motor 110V [EXTREME]
-	24	Motor 230V [EXTREME]
-		Motor Clamp
-		Neoprene Ball 5/16"
-		GRD 1 - manifold part
-	25	Male Kettle Lead 240V
-	25	Male Kettle Lead 110V
-		Rivnut 10-24
-	26	Switch - Start
-	27	Switch - On/Off
-	28	Switch - Vacuum Select
-	25	Vacuum Sensor

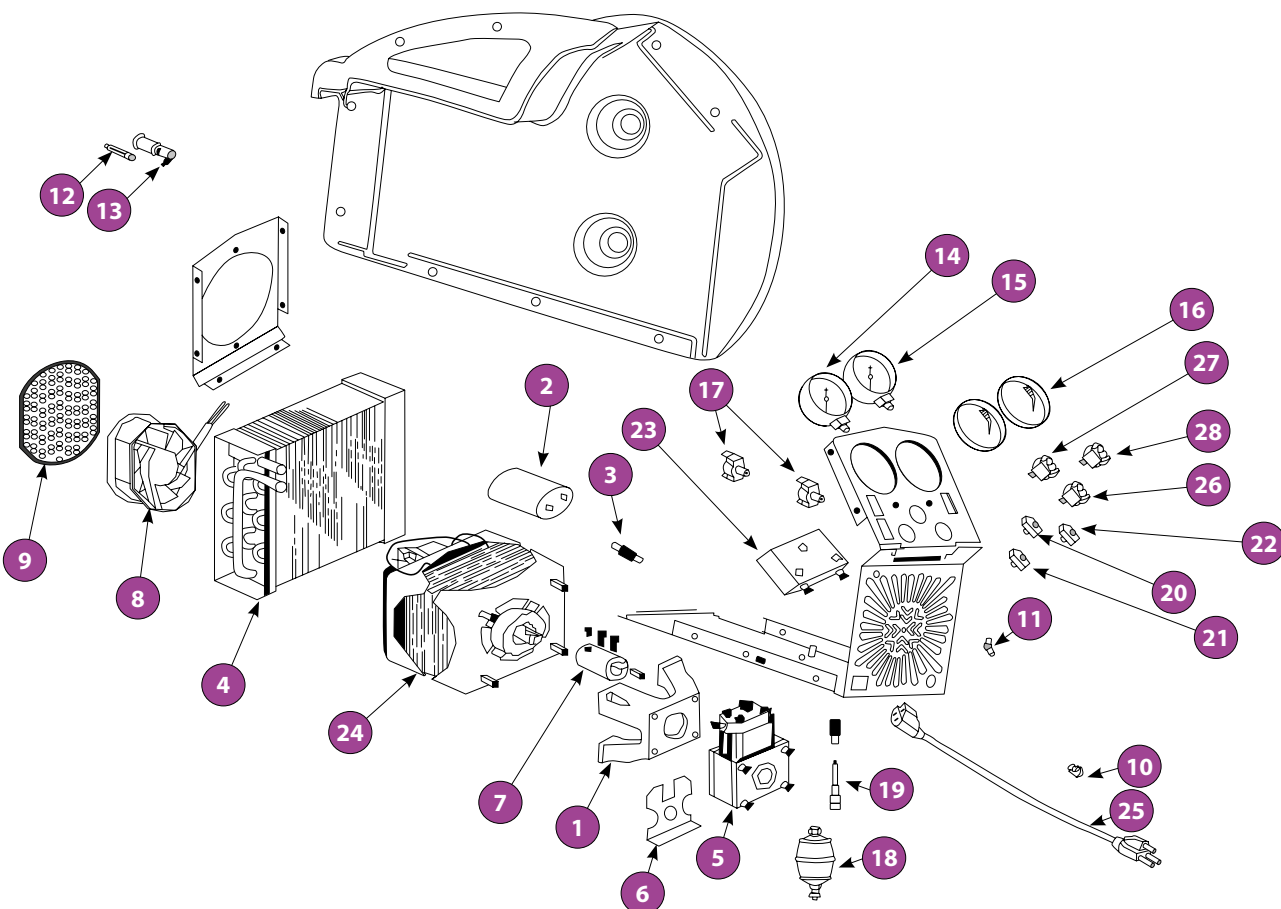

RECOVERY MACHINES

COMPARISON CHARTS



BOSCH RG-4.0



PROMAX RG3000



PROMAX MINIMAX



PROMAX RG5410A

Technical information	BOSCH RG-4.0	PROMAX RG3000
Motor	1/2 HP / 360 Watt	1/3 HP / 240 Watt
Max. Working Pressure	38.5 Bar	38.5 Bar
No. of cylinders	1	1
Norm	EN 35421	EN 35421
Approvals	CE, UL, ARI and TÜV	CE, UL, ARI and TÜV
Filter / dryer	Yes	Yes
HP safety switch	Yes	Yes
Dimensions	450 x 250 x 350 mm	310 x 235 x 175 mm
Weight	14.6 kg	8 kg

Technical information	PROMAX MINIMAX	PROMAX RG5410A
Motor	1/2 HP / 360 Watt	1/3 HP / 240 Watt
Max. Working Pressure	38.5 Bar	38.5 Bar
No. of cylinders	1	1
Norm	EN 35421	EN 35421
Approvals	CE, UL, ARI and TÜV	CE, UL, ARI and TÜV
Filter / dryer	Yes	Yes
HP safety switch	Yes	Yes
Dimensions	406 x 250 x 222 mm	485 x 325 x 245 mm
Weight	11 kg	13.5 kg

Part code	Description	Quantity
BOSCH RG-4.0A	Bosch Recovery Unit - 240 V 50-60Hz	1
BOSCH RG -4.0B	Bosch Recovery Unit - 110 V 50-60Hz	1
RG 3000 E2 30V	Promax Ultra Compact Recovery Unit - 240V 50Hz only	1
RG 3000 E	Promax Ultra Compact Recovery Unit - 110V 50Hz only	1
MINIMAX	Promax Minimax Compact Recovery Unit - 240V 50-60Hz	1
MINIMAX E	Promax Minimax Compact Recovery Unit - 110V 50-60Hz	1
RG 5410A E240V	Promax Recovery Unit - 240V 50-60Hz	1

LEAK DETECTION



LEAK DETECTION

BOSCH CS LD 1.0



LEAK DETECTOR

- One sensor, one tool
- Detects Halogenated CFC, HCFC, HFC, HFO compounds, HC refrigerants, Tracer Gas (95 %N₂/5 %H₂ mixture), ammonia, butane and propane
- Meets or exceeds EN14624 performance standards
- Ultimate Sensitivity of less than 1 g/yr
- Electronic sensor lasts > 5 years
- Large 61 mm backlit graphic LCD
- Audible alarm with Mute and Visual Leak Size Indicator
- Leak tracing mode to pinpoint hard to find leaks
- Rubber keypad provides positive actuation and tactile feedback
- Ergonomic design with TPU overmold and ambidextrous operation
- Includes carrying case, spare filters and battery charger



Technical information	Bosch CS LD 1.0
Dimensions (L x W x H)	218 x 83 x 51 mm
Probe Length	413 mm
Weight	452 grams
Sensor Life	Approximately 5 years under normal usage
Warm Up Time	Normally 20 - 30 seconds, 45 seconds Max.
Ultimate Sensitivity	< 1 g/yr
Power Supply	Li-Ion rechargeable cell
Battery Life (per charge)	8 hours
Recharge time	≤ 3 hours
Operating Temperature & Humidity	-20° C to 50° C; 95 % RH max.
IP Rating	IP IP51

Code	Description	Quantity
BOSCH CS LD 1.0	Leak Detector	1

BOSCH IR LD 1.0



LEAK DETECTOR

The BOSCH IR LD 1.0 CO₂ leak detector is specifically designed to detect R-744 - Carbon Dioxide (CO₂). This leak detector meets / exceeds EN14624 performance standards with an ultimate sensitivity of less than 2 g/yr. The BOSCH IR LD 1.0 CO₂ leak detector includes carrying case, spare filters and battery charger, and comes with a 2-year warranty.

- Infrared sensor lasts for years and is stable and reliable
- Large 61 mm backlit graphic LCD
- Audible alarm with mute and visual leak size indicator
- Rechargeable Li-Ion battery provides superior performance and saves on operating costs
- Rubber keypad provides positive actuation and tactile feedback
- Ergonomic design with TPU overmold and ambidextrous operation



Technical information	BOSCH IR LD 1.0
Dimensions (L x W x H)	218 x 83 x 51 mm
Probe Length	413 mm
Weight	452 grams
Sensor Life	Approximately 5 years under normal usage
Warm Up Time	Normally 50 - 60 seconds, 90 seconds Max.
Ultimate Sensitivity	< 2 g/yr
Power Supply	Li-Ion rechargeable cell
Battery Life (per charge)	8 hours
Recharge time	≤ 3 hours
Operating Temperature & Humidity	-20°C to 50°C - 95% RH MAX
IP Rating	IP51

Code	Description	Quantity
BOSCH-IR-LD	Leak Detector	1

TIF XP-1A



ELECTRONIC LEAK DETECTOR FROM TIF

The TIF XP-1A features a mechanical pump which ensures that moving air from the immediate environment is continuously flowing over the sensing tip for it to sample.

The sensing tip is monitored by the microprocessor 4000 times a second and can detect leaks down to 3 grams of refrigerant per year. The kit comes complete with 2 sensors, (each with a 20 hour life), batteries, a hard carry case and a two year warranty.



- Detects all halogenated refrigerants
- Variable frequency audible alarm
- LED lights to indicate a leak
- Constant power indication
- Suitable for A2L Refrigerants such as R32 and R1234YF
- Mute Button
- 2-year warranty

Technical information

Ultimate sensitivity	3 gr/yr
Power supply	2 x 'C' Batteries
Battery life	Approx. 30 hours
Sensor life	20 hours
Operating temperature	-20°C to 52°C

Part code	Description	Quantity
TIF-XP-1A	Automatic Halogen refrigerant leak detector	1
TIF-XP-2	Maintenance kit (3 tips with protectors)	1

TIF ZX-1A



ELECTRONIC LEAK DETECTOR FROM TIF

This is the most sensitive and most advanced completely digital hand held leak detector available today. The ZX-1A eliminates false alarms from moisture, cleaners and solvents and allows you to home into even the smallest refrigerant leak without misleading feedback. Reliability is a key feature of the ZX-1A – the unit is equipped with a sensor failure indicator, a battery test function giving true voltage indication and a low battery indicator.

- Detects ALL halogenated refrigerants
- Suitable for A2L refrigerants such as R32 and R1234YF
- Wall charger included
- Rechargeable
- Mute Button
- Patented heated pentode sensor
- Highest sensitivity in the market less than 3g/year
- True mechanical pump provides instant response
- Tri-colour leak size indication display
- 2-year warranty

Technical information	
Ultimate sensitivity	Less than 3 gr/yr for all refrigerants
Power supply	Ni-MH Battery Pack
Battery life	5-6 hours
Sensor life	100-150 hours
Operating temperature	0 to 50°C (32 to 122°F)

Part code	Description	Quantity
TIF ZX-1A	Heated Pentode™ Refrigerant Leak Detector	1
TIF ZX-2	Heated Pentode™ Sensor for ZX-1A	1
TIF ZX-14	Filter & Tip for ZX-1A	1
TIF ZX-20	Nickle-Metal Hydride (NiMH) Battery Pack for ZX-1A	1

TIF IR-1A



INFRARED SENSOR LEAK DETECTOR FROM TIF

The TIF IR-1A uses infrared optics to create a refrigerant leak detector that combines sensitivity, speed, battery life, portability and ease of use. This unit will detect leaks as small as 3 g/yr, and exceeds EN 14624. The TIF IR-1A comes with a wall charger for its compact lithium-ion battery, which can power the leak detector for up to eight hours of continuous operation before needing to recharge.

- Advanced infrared sensor designed to last a minimum of 10 years
- Three sensitivity levels down to 3gr/yr
- Automatically recalibrates in highly contaminated areas to help pinpoint the exact location of the leak
- Suitable for A2L refrigerants such as R32 and R1234YF
- Won't trigger with oil or moisture
- Senses CFC, HFC and HCFC blend refrigerants
- 8-hour lithium Ion battery lasts all day long and beyond
- Visual alert make it easy to find leaks in noisy environments
- Audible alert with mute button
- Durable carrying case let's you easily store the leak detector and accessories
- Certified to SAE J2913 / SAE J2791 / E-35422 / EN 14624
- 1-year warranty

Technical information	
Ultimate sensitivity	Less than 3 gr/yr
Power supply	3.7v Lithium-Ion rechargeable battery
Battery life	8 hours
Operating temperature	0 to 5 0°C (32 to 122°F)

Part code	Description	Quantity
TIF IR-1A	Infrared Sensor Leak Detector	1
TIF IR-8	Maintenance Kit 5 x Filters and 3 x O rings	1

TIF 8900-E

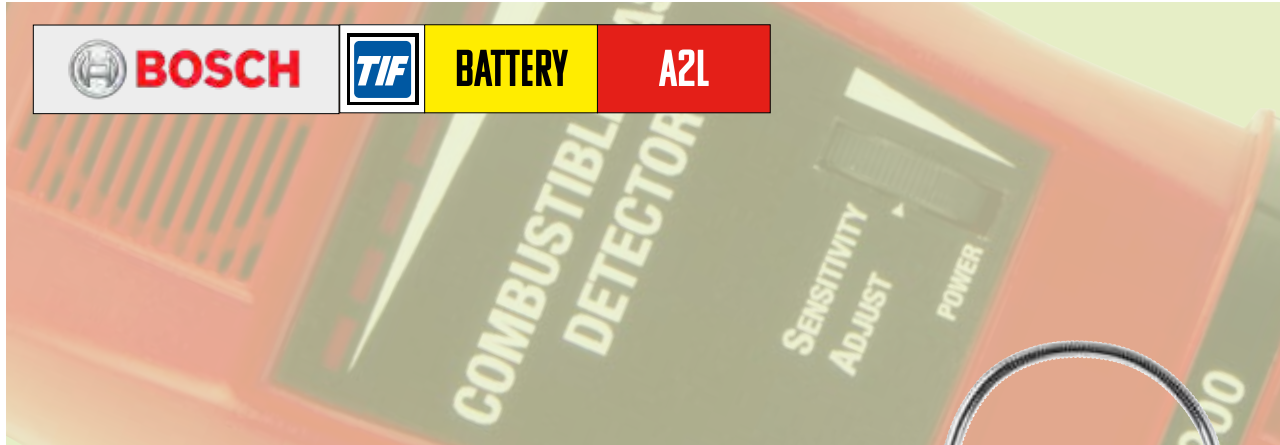

COMBUSTABLE GAS LEAK DETECTOR FROM TIF

The TIF 8900 combustible gas leak detector pinpoints the location of combustible gas leaks as low as 1 ppm. The TIF 8900 can be used to leak check refrigeration systems that use hydrocarbon combustible gases. This battery-powered unit features a flexible 16-inch probe and a Geiger counter-style ticking signal that increases in frequency as the source of the combustible gas is detected. The TIF 8900 is supplied with a carrying case, owner's manual, rechargeable batteries & charger.

- For flammable gasses like Propane, Iso-Butane and Ammonia
- Suitable for Tracer Gas (95% Nitrogen and 5% Hydrogen)
- Suitable for A3 refrigerants such as R290 and R600a
- Sensitivity as low as 1 ppm in: <500 ppm
- Long-life solid state sensor
- 1-year warranty



Technical information	
Ultimate sensitivity	As low as 1 ppm in: <500 ppm
Power supply	2 x 2.4v rechargeable batteries
Battery life	4 hours
Sensor life	up to 150 hours
Operating temperature	0°C to 52°C

Part code	Description	Quantity
TIF 8900-E	Combustible Gas Leak Detector	1
TIF 8806-A	Rechargeable batteries (2 each)	1
TIF 8806-B	Battery Charger 240V	1
TIF 8801	Replacement Sensor	1

ATP-C1

INFRARED SENSOR CO₂ REFRIGERANT LEAK DETECTOR

The ATP-C1 Carbon Dioxide Gas Leak Detector is the most technologically advanced of its kind. The fully automatic ATP-C1's low power requirements, small size and high sensitivity combine to create a tool which is easy to handle and ultra effective at locating even the most difficult-to-find leaks. The ATP-C1's long life sensor will detect concentrations of carbon dioxide gas as low as 400 ppm over ambient. False alarms are eliminated due to its high selectivity. The ATP-C1 is excellent for servicing carbon dioxide refrigeration systems or any general purpose leak detection application where compressed carbon dioxide can be used as the test gas.

- Simple, one button operation
- Sensitivity: <400 ppm
- Long life IR sensor
- Special design for CO₂
- 4 x 1.5V - AA Alkaline Batteries (6V DC)
- Low battery indicator
- Reset time, 1 second (auto reset)
- 1-year warranty

Technical information	
Ultimate sensitivity	< 400 pp m
Power supply	4 x 1,5V AA alkaline batteries
Battery life	10 hours
Sensor life	> 2 years - maintenance free
Operating temperature	0° to 50°C

Part code	Description	Quantity
ATP-C1	Infrared Sensor CO ₂ Refrigerant Leak Detector	1
ATP-C2	Replacement Sensor	1

REFRIGERANT WEIGHING SCALES



TIF-9000S

**DUAL RANGE COMPACT REFRIGERANT SCALE
50KG/2G & 100KG/4G**

- Dual range 100kg or 50kg
- Dual resolution, 4 or 2 grams
- Platform mounting connection for small cylinders
- Auto shut-off feature saves battery life when the unit is not in use
- Extra large display with built-in backlight
- Integrated carrying handle
- Comes complete with a shoulder bag
- Optional operating modes
- Overload protection
- 1-year warranty

**CALIBRATION
CERTIFICATION
SERVICE AVAILABLE
ON ALL SCALES**



Technical information	
Capacity	50kg or 100kg selection table
Accuracy	3 0.5% of reading \pm 1 digit
Resolution	2 or 4 gram selectable
Platform dimensions	250mm (W) 250mm (L)
Weight	4.2kg
Battery type	1 x 9V alkaline battery
Battery life	\pm 20 hours
Operating temperatures	-10°C to 49°C
Case	No
Bag	Yes

Part code	Description	Quantity
TIF-9000S	TIF Dual Range Compact Refrigerant Scale	1

TIF-9030E

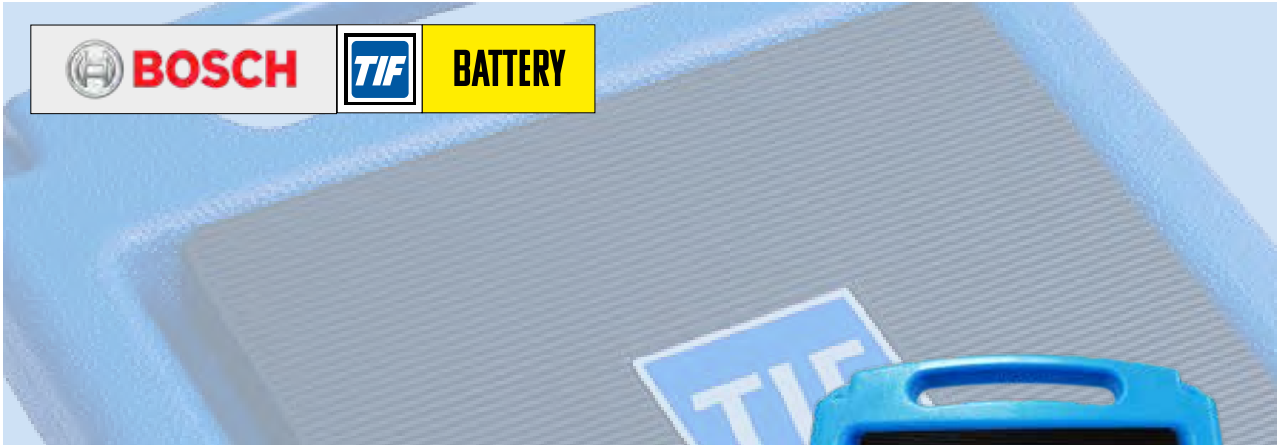

COMPACT REFRIGERANT SCALE UP TO 100KG

- Compact design
- Extremely durable
- Range up to 100kg
- Display weight in kg, oz, lbs
- Resolution 10g
- Easy to use: On/Off - Units - Zero buttons
- 9V battery operated
- Overload protected
- Inclusive Shoulder bag
- CE approved
- 1-year warranty

**CALIBRATION
CERTIFICATION
SERVICE AVAILABLE
ON ALL SCALES**



Technical information	
Capacity	Up to 100kg
Accuracy	± 0.5% of reading ± 1 digit
Resolution	10 gram
Platform dimensions	230mm (W) 230mm (L)
Weight	2.4kg
Battery type	1 x 9V alkaline battery
Battery life	± 20 hours
Operating temperatures	-10°C to 49°C
Case	No
Bag	Yes

Part code	Description	Quantity
TIF-9030E	TIF Compact Refrigerant Scale up to 100 kg	1

TIF-9060S

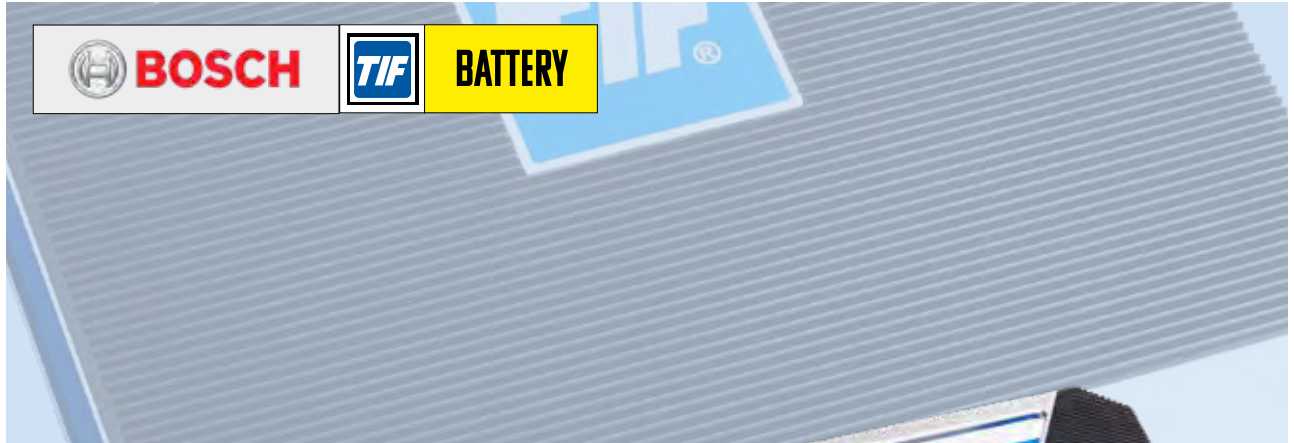
**HEAVY-DUTY ALUMINIUM SCALE
UP TO 150KG**

- Maximum capacity 150kg
- Extremely large platform
- 6 digit LCD readout
- Easy to handle
- Three units to select from kg, lbs, lbs/ozs
- Resolution 10g, 0,02 lbs and 0,5 oz
- Low Battery indicator (<7.5 V DC)
- Platform 270 x 260 mm
- Overload protected
- Includes nylon carrying case
- CE approved
- 1-year warranty

**CALIBRATION
CERTIFICATION
SERVICE AVAILABLE
ON ALL SCALES**



Technical information	
Capacity	150kg
Accuracy	± 0.5% of reading ± 1 digit
Resolution	2 or 4 gram
Platform dimensions	260mm (W) 270mm (L)
Weight	5.3kg
Battery type	1 x 9V alkaline battery
Battery life	± 20 hours
Operating temperatures	-10°C to 49°C
Case	No
Bag	Yes

Part code	Description	Quantity
TIF-9060S	TIF Heavy-Duty Aluminium Scale up to 150 kg	1

CONDENSATE PUMPS AND ACCESSORIES

MINI PUMPS

DiversiTech International stock a range of mini condensate pumps ideal for split air conditioning systems, small enough to be placed in the unit, or within trunking. We also provide mini pump options that come with an elbow and length of trunking.

AIR CONDITIONING

WHAT'S IN THE CATALOGUE



EC-1 (PUMP ONLY)



WHISPA-Q MINI



WHISPA-Q MINI AND TRUNKING



EC-1 KIT with elbow and trunking



DE-05-FD Flowwatch Design® with elbow and trunking

Part code	Description	Max head	Max flow	dB(A)	Dimensions mm (HxWxD)	Discharge size (inches)
EC-1	1 Litre Tank Pump	10m	10LPH	21	104x46x58	1/4"
EC-1 KIT	Mini pump with trunking	10m	10LPH	21	104x46x58	1/4"
DE-05-FD	Mini pump with trunking	10m	12LPH	< 21	800x150x80	1/4"
WHISPA-Q-MINI	Mini pump	6m	16LPH	21	-	-
WHISPA-Q-TRUNK	Mini pump with trunking	6m	16LPH	21	-	-
MF-2	Mini Flowwatch 2	10m	12LPH	< 21	800x150x80	-

FIND ME ON PAGE 21

TIF-9055

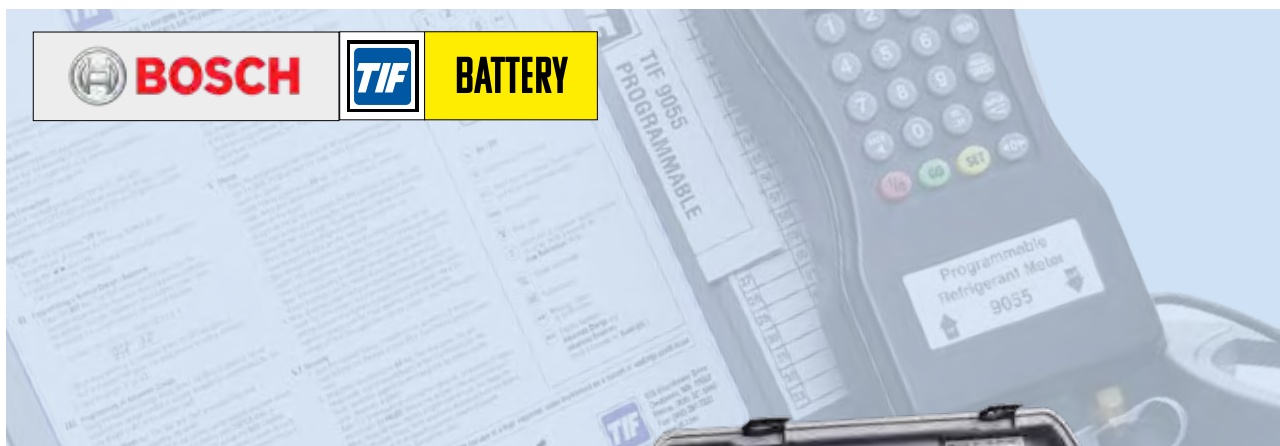
PROGRAMMABLE CHARGING / RECOVERY SCALE UP TO 100KG

- 100kg (220 lbs) capacity
- Allows automatic Charging or Recovery operations
- Colour-coded keypad controls
- Three display modes – kg, lbs/oz, Decimal Pounds
- Very High Resolution – 4g / 0.2 oz / 0.010 lbs
- Can be used with all refrigerants, including (R410A)
- Advanced Charge and Recovery Modes – uses tare weight and max. capacity of cylinder to calculate maximum charge/recovery available
- Removable platform and control box with prop stand/hanging hook
- Compact Design – completely portable, battery powered
- Low battery indicators
- 1-year warranty



**CALIBRATION
CERTIFICATION
SERVICE AVAILABLE
ON ALL SCALES**

Technical information

Capacity	Up to 100kg
Accuracy	± 0.5% of reading ± 1 digit
Resolution	4 gram
Platform dimensions	230mm (W) 230mm (L)
Weight	4kg
Battery type	1 x 9V alkaline battery and 4 x 1.5V AA batteries
Battery life	± 30 hours
Operating temperatures	-10°C to 45°C
Case	No
Bag	Yes

Part code	Description	Quantity
TIF-9055	TIF Programmable Charging / Recovery Scale up to 100 kg	1

TIF-9010A



“SLIMLINE” REFRIGERANT SCALE UP TO 50KG

- Capacity range up to 50kg / 110 Pound capacity
- Three display modes – kg, lbs/oz, Decimal Pounds
- Very High Resolution 2g / 0.1 oz / 0.005 lbs at 50kg
- Extreme Accuracy
- Proven technology
- Auto Zero
- Removable platform and control box with prop stand/hanging hook
- Compact design, completely portable
- Overload protected
- 2-year warranty



Technical information	
Capacity	Up to 50kg
Accuracy	± 0.5% of reading ± 1 digit
Resolution	2 gram
Platform dimensions	230mm (W) 230mm (L)
Weight	2.9kg
Battery type	1 x 9V alkaline battery
Battery life	± 20 hours
Operating temperatures	-10°C to 49°C
Case	No
Bag	Yes

Part code	Description	Quantity
TIF-9010A	TIF “Slimline” Refrigerant Scale up to 50kg	1

COMPARISON CHART

COMPARISON CHARTS

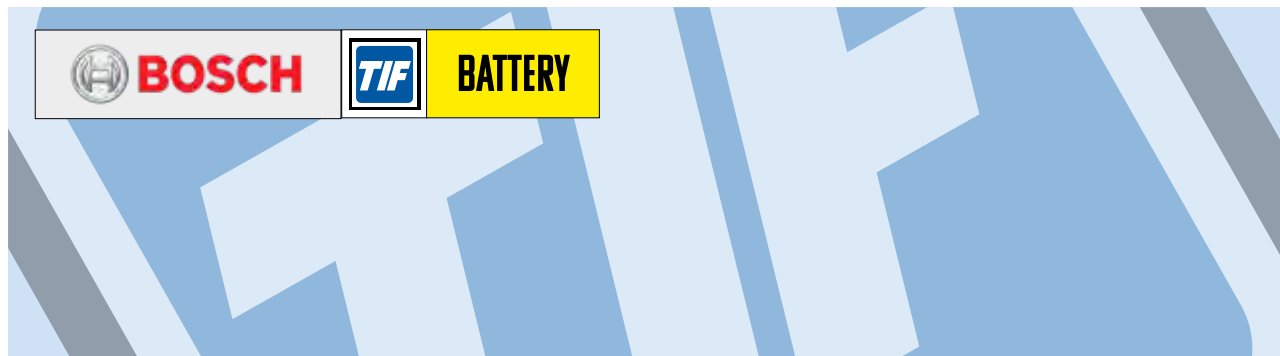

Technical information	TIF-9000S	TIF-9030E	TIF-9060S
Capacity	Up to 100kg	Up to 100kg	150kg
Accuracy	± 0.5% of reading ± 1 digit	± 0.5% of reading ± 1 digit	± 0.5% of reading ± 1 digit
Resolution	2 or 4 grams selectable	10 gram	2 or 4 gram
Platform dimensions	250mm (W) 250mm (L)	230mm (W) 230mm (L)	260mm (W) 270mm (L)
Weight	4.2kg	2.4kg	5.3kg
Battery type	1 x 9V alkaline battery	1 x 9V alkaline battery	1 x 9V alkaline battery
Battery life	± 20 hours	± 20 hours	± 20 hours
Operating temperatures	-10°C to 49°C	-10°C to 49°C	-10°C to 49°C
Case	No	No	No
Bag	Yes	Yes	Yes

Technical information	TIF-9010A	TIF-9055
Capacity	Up to 50kg	Up to 100kg
Accuracy	± 0.5% of reading ± 1 digit	± 0.5% of reading ± 1 digit
Resolution	2 gram	4 gram
Platform dimensions	230mm (W) 230mm (L)	230mm (W) 230mm (L)
Weight	2.9kg	4kg
Battery type	1 x 9V alkaline battery	1 x 9V alkaline battery and 4 x 1.5V AA batteries
Battery life	± 20 hours	± 30 hours
Operating temperatures	-10°C to 49°C	-10°C to 45°C
Case	No	No
Bag	Yes	Yes

Part code	Description	Quantity
TIF-9000S	TIF Dual Range Compact Refrigerant Scale	1
TIF-9030E	TIF Compact Refrigerant Scale up to 100 kg	1
TIF-9000S	TIF Heavy-Duty Aluminium Scale up to 150 kg	1
TIF-9055	TIF Programmable Charging / Recovery Scale up to 100 kg	1
TIF-9010A	TIF "Slimline" Refrigerant Scale up to 50kg	1

VACUUM PUMPS



PREMIUM PUMPS



RA-15401 / RA-15601 / RA-15121A

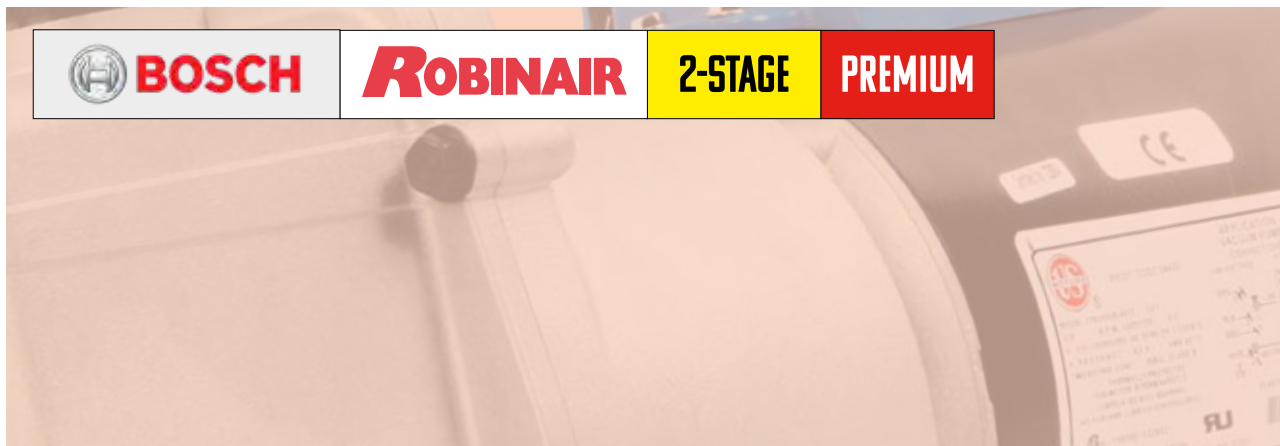

PREMIUM HIGH-QUALITY COOLTECH VACUUM PUMPS

Robinair Cooltech are the industry's most efficient, reliable and dependable vacuum pumps. Lightweight and durable, the high-torque design of the motor allows for easy start-up and efficient operation. Cooltech pumps also feature the patented Iso-valve, which isolates the pump from the system with just a quarter-turn. All Cooltech pumps are built from die-cast aluminium, making them lightweight but durable. An integral check valve is also a standard feature, which prevents oil from being sucked into the system if a power loss occurs.

- Two-stage design
- Offset rotary vanes
- Gas ballast
- Iso-valve
- Dual-voltage
- 1-year warranty



Tecnical information	RA-15401	RA-15601	RA-15121A
Capacity	4 CFM 9 3 l/min	6 CFM 9 3 l/min	10 CFM 9 3 l/min
Ultimate vacuum level	20 Micron (2.67 Pa)	20 Micron (2.67 Pa)	20 Micron (2.67 Pa)
Motor	244 Watt	366 Watt	366 Watt
Voltage	110V / 240V (50-60Hz)	110V / 240V (50-60Hz)	110V / 240V (50-60Hz)
Gas ballast	Yes	Yes	Yes
Oil capacity	445ml	445ml	448ml
Dimensions (HxWxL)	247x143x420mm	247x143x420mm	272x143x445mm
Inlet connection	1/4" /1/2"/3/8" MFL	1/4" /1/2"/3/8" MFL	1/4" /1/2"/3/8" MFL
Weight	12kg	12kg	17kg
Number of stages	2	2	2

Part code	Description	Quantity
RA-15401	Premium Robinair COOLTECH vacuum pump - 4CFM	1
RA-15601	Premium Robinair COOLTECH vacuum pump - 6CFM	1
RA-15121A	Premium Robinair COOLTECH vacuum pump - 10CFM	1

RA-15301A-E / RA-15501A-E / RA-15801A-E

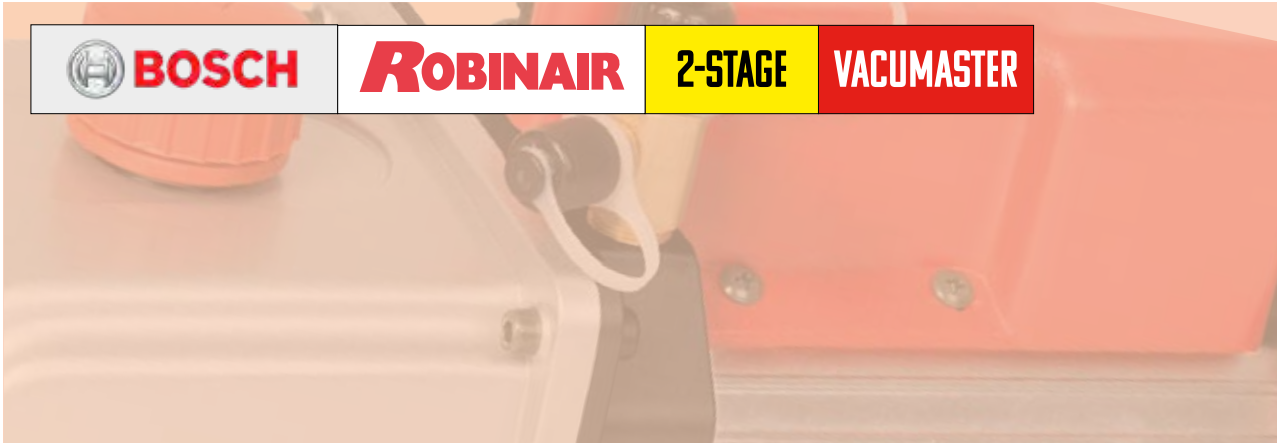

VACUMASTER VACUUM PUMPS

This range of pumps comes with a sure-grip handle (a one-piece, moulded handle) which makes it easy to carry to site. The handle also stays cool to the touch during operation. The two-stage rotary vane design means the pump is powerful, quiet, has a high vacuum capacity. Gas ballast allows a precise amount of atmospheric air to be introduced into the pump, preventing condensation of moisture vapour - which helps to maintain the purity of the pump oil.

- Compact and lightweight
- Quiet operation
- 2-stage rotary vane design
- Easy cold start with gas ballast
- Dual-voltage
- 1-year warranty



Technical information	RA-15301A-E	RA-15501A-E	RA-15801A-E
Capacity	3 CFM 84 l/min	5 CFM 128 l/min	8 CFM 226 l/min
Ultimate vacuum level	15 Micron (2 Pa)	15 Micron (2 Pa)	15 Micron (2 Pa)
Motor	450 Watt	500 Watt	650 Watt
Voltage	110V / 240V (50-60Hz)	110V / 240V (50-60Hz)	110V / 240V (50-60Hz)
Gas ballast	Yes	Yes	Yes
Oil capacity	450ml	500ml	700ml
Dimensions (HxWxL)	335x140x255mm	335x140x255mm	376x157x270mm
Inlet connection	1/4"/3/8" SAE MFL	1/4"/3/8" SAE MFL	1/4"/3/8" SAE MFL
Weight	9.5kg	10.2kg	13.9kg
Number of stages	2	2	2

Part code	Description	Quantity
RA-15301A-E	Robinair VACUMASTER vacuum pump - 3CFM	1
RA-15501A-E	Robinair VACUMASTER vacuum pump - 5CFM	1
RA-15801A-E	Robinair VACUMASTER vacuum pump - 8CFM	1

ROBINAIR VACUMASTER



A2, A2L & NH₃ VACUUM PUMP

This pump comes with a sure-grip handle (a one-piece, moulded handle) which makes it easy to carry to site. The handle also stays cool to the touch during operation. The two-stage rotary vane design means the pump is powerful, quiet, has a high vacuum capacity. Gas ballast allows a precise amount of atmospheric air to be introduced into the pump, preventing condensation of moisture vapour - which helps to maintain the purity of the pump oil.

- For all common refrigerants
- For class A2L refrigerants
- For Ammonia (NH₃)
- Spark free electronic motor cut-out switch
- Spark free electronic On/Off switch
- 240V / 50Hz only
- 1-year warranty

Technical information	RA-15501A-E-A2L
Capacity	5 CF M 12 8 l/min
Ultimate vacuum level	15 Micron (2 Pa)
Motor	500 Watt
Voltage	240V / 50Hz only
Gas ballast	Yes
Oil capacity	500ml
Dimensions (HxWxL)	340x150x270mm
Inlet connection	Nickel Plated Steel 1/4"/3/8" SAE MFL
Weight	10.2kg
Number of stages	2



Part code	Description	Quantity
RA-15501A-E-A2L	VacuMaster Robinair vacuum pump - for A2, A2L and Ammonia - 5CFM	1

ROBINAIR RA-VG-64A



DIGITAL VACUUM GAUGE

A durable self-contained battery powered vacuum gauge with LCD visual screen. Allows reading from 0 - 12,000 Microns. The unique design of the RA-VG-64A allows in-line connection through the system.

- Easy to use
- LCD visual screen
- Convenient Built-in magnetic hanger
- Sensor cleaning possible



Technical information	
Dimensions	135x75x40mm
Connections	1/4" MFL
Power supply	9V Battery
Sensor type	Thermistor
Response time	0.5 seconds
Units	Micron, psi, inHg, Millibar, Pascal, Torr, Millitorr
Battery life	Approx. 30 hours
Automatic shut-off	>10 Minutes - 12,000 Microns
Resolution	0-200 : 1 Micron 201-500 : 5 Microns 501-1000 : 10 Microns 1001-2000 : 50 Microns 2001-5000 : 250 Microns 5001-8000 : 500 Microns 8001-12000 : 1000 Microns
Accuracy	± 10 % of reading
Maximum pressure	20 bar / 300 psi
Operating temperature	2°C to 52°C

Part code	Description	Quantity
RA-VG-64-A	Digital LCD display vacuum gauge	1

ROBINAIR PREMIUM VACUUM PUMP OIL



ROBINAIR PREMIUM HIGH VACUUM PUMP OIL

- Mineral oil
- Chemically engineered to maintain maximum viscosity at high running temperatures and to improve cold weather starts
- Thermal stability – resists break-down due to heat
- Lower moisture content – due to special packaging and handling procedures
- Performance of your pump depends largely on the quality and purity of the vacuum pump oil that you use



Part code	Description	Quantity
RA-13119	Premium High Vacuum Pump Oil, 0.475 L litres (16oz)	12
RA-13203	Premium High Vacuum Pump Oil, 0.95 Li tres (32oz)	12
RA-13204	Premium High Vacuum Pump Oil, 3.8 Litres (128.5oz)	4

COMPARISON CHARTS

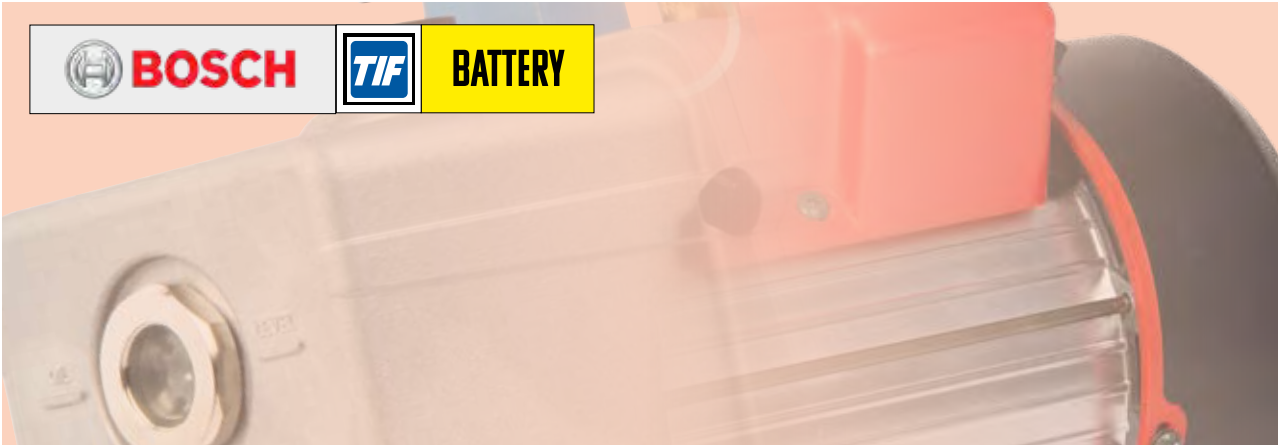

ROBINAIR COOLTECH / VACUMASTER

Technical information	RA-15401	RA-15601	RA-15121A
Capacity	4 CFM 9 3 l/min	6 CFM 9 3 l/min	10 CFM 9 3 l/min
Ultimate vacuum level	20 Micron (2.67 Pa)	20 Micron (2.67 Pa)	20 Micron (2.67 Pa)
Motor	244 Watt	366 Watt	366 Watt
Voltage	110V / 240V (50-60Hz)	110V / 240V (50-60Hz)	110V / 240V (50-60Hz)
Gas ballast	Yes	Yes	Yes
Oil capacity	445ml	445ml	448ml
Dimensions (HxWxL)	247x143x420mm	247x143x420mm	272x143x445mm
Inlet connection	1/4" /1/2"/3/8" MFL	1/4" /1/2"/3/8" MFL	1/4" /1/2"/3/8" MFL
Weight	12kg	12kg	17kg
Number of stages	2	2	2

Technical information	RA-15501A-E-A2L	RA-15301A-E	RA-15501A-E	RA-15801A-E
Capacity	5 CF M 12 8 l/min	3 CFM 84 l/min	5 CFM 128 l/min	8 CFM 226 l/min
Ultimate vacuum level	15 Micron (2 Pa)	15 Micron (2 Pa)	15 Micron (2 Pa)	15 Micron (2 Pa)
Motor	500 Watt	450 Watt	500 Watt	650 Watt
Voltage	240V / 50Hz only	110V / 240V (50-60Hz)	110V / 240V (50-60Hz)	110V / 240V (50-60Hz)
Gas ballast	Yes	Yes	Yes	Yes
Oil capacity	500ml	450ml	500ml	700ml
Dimensions (HxWxL)	340x150x270mm	335x140x255mm	335x140x255mm	376x157x270mm
Inlet connection	Nickel Plated Steel 1/4"/3/8" SAE MFL	1/4"/3/8" SAE MFL	1/4"/3/8" SAE MFL	1/4"/3/8" SAE MFL
Weight	10.2kg	9.5kg	10.2kg	13.9kg
Number of stages	2		2	2



CONDENSATE PUMPS AND ACCESSORIES

REDBOX-1L-S 1 LITRE CONDENSATE PUMP

The DiversiTech RedBox 1 Litre Tank Pump is a condensate tank pump with a flow rate of 280 LPH and a lift of 5.1 metres. This pump has metal mounting tabs which allows the tank to be screwed to the wall. The universal power lead makes the pump easy to install, service and retrofit.

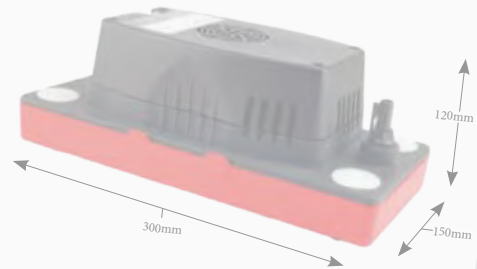
The unique LED indicators highlight when the pump has power, is running and when the high level alarm has been activated.



-  MAX. FLOW 280 LPH
-  TANK CAP. 1L
-  DECIBEL RATING 44 DB(A)

Part code	Max. lift	Discharge size	Watts	IP	Amps	Volts	HZ
REDBOX-1L-S	5.1m	3/8" / 1/4"	60W	20	1.0A	230V	50Hz



High level alarm	Inlet height fr. base	Weight	Cable length	Drink cycle	On level	Off level	Reserve before overflow	Alarm level
230V / 3A	112mm	2.3kg	1.8m	460ml	15.5mm	6mm	140ml	25mm

REDBOX-2L-S 2 LITRE CONDENSATE PUMP

The DiversiTech RedBox 2 Litre Tank Pump is a condensate tank pump with a flow rate of 280 LPH and a lift of 5.1 metres. This pump has metal mounting tabs which allows the tank to be screwed to the wall. The universal power lead makes the pump easy to install, service and retrofit.

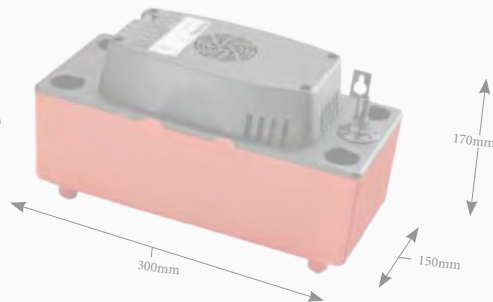
The unique LED indicators highlight when the pump has power, is running and when the high level alarm has been activated.



-  MAX. FLOW 280 LPH
-  TANK CAP. 2L
-  DECIBEL RATING 44 DB(A)

Part code	Max. lift	Discharge size	Watts	IP	Amps	Volts	HZ
REDBOX-2L-S	5.1m	3/8" / 1/4"	60W	20	1.0A	230V	50Hz

Weight	Cable length	Drink cycle	On level	Off level	Reserve before overflow	Alarm level
2.3kg	1.8m	1.45	47mm	6.5mm	375ml	52mm

FIND ME ON
PAGE 20

HAND TOOLS



ROBINAIR RA-EXP-SET



HYDRAULIC TUBE EXPANDER SET

The RA-EXP-SET (tube expander set) couples hydraulic pressure with a lightweight tool to create a perfect and effortless expansion of copper, aluminium and brass pipes - with just a few pumps of the lever.

- 1/4 to 1-1/8 expander heads included in the kit
- Single-handed operation
- Laser-engraved expander heads are easy to identify and attach
- Compact design permits working in hard to access areas
- Expander heads for metric and imperial
- De-burring tool included in the kit
- Angled and ergonomic design
- 1-year warranty



Part code	Description	Quantity
RA-EXP-SET	ROBINAIR hydraulic pipe expander set with 1/4 - 1-1/8" expander heads	1
RA-EXP	ROBINAIR hydraulic pipe expander	1
RA-EXP-C-D	ROBINAIR hydraulic pipe expander with carry case	1
ADDITIONAL HEADS - NOT INCLUDED IN THE SET)		
RA-EXP-1/4	Expander head 1/4"	1
RA-EXP-3/8	Expander head 3/8"	1
RA-EXP-1/2	Expander head 1/2"	1
RA-EXP-5/8	Expander head 5/8"	1
RA-EXP-3/4	Expander head 3/4"	1
RA-EXP-7/8	Expander head 7/8"	1
RA-EXP-1-1/8	Expander head 1-1/8"	1
RA-EXP-1-3/8	Expander head 1-3/8"	1
RA-EXP-1-5/8	Expander head 1-5/8"	1
RA-EXP-DBT	Deburring tool	1

SPIN TOOLS



These flaring and swaging tools are designed for most tubing diameters, and they allow you to connect tubes without the need for extra fittings (swage), and preserves the copper malleability (flare) thus preventing cracks and leaks.



Part code	Description
FLARING TOOL SETS	
F4000	1/4, 3/8, 1/2, 5/8
F5000	1/4, 3/8, 1/2, 5/8, 3/4
F6000	1/4, 3/8, 1/2, 5/8, 3/4, 7/8
SWAGING TOOL SETS	
S4000	1/4, 3/8, 1/2, 5/8
S5000	1/4, 3/8, 1/2, 5/8, 3/4
S6000	1/4, 3/8, 1/2, 5/8, 3/4, 7/8
P3000	PLUMBING 1/2, 3/4, 1"
FLARING HEADS, INCHES	
F1014	1/4"
F1516	5/16"
F1038	3/8"
F1012	1/2"
F1058	5/8"
F1034	3/4"
F1078	7/8"

Part code	Description
SWAGING HEADS, INCHES	
S1014	1/4"
S1516	5/16"
S1038	3/8"
S1012	1/2"
S1058	5/8"
S1034	3/4"
S1078	7/8"
S6000	1/4, 3/8, 1/2, 5/8, 3/4, 7/8
P3000	PLUMBING 1/2, 3/4, 1"
FLARING TOOL SETS	
F4000	1/4, 3/8, 1/2, 5/8
F5000	1/4, 3/8, 1/2, 5/8, 3/4
F6000	1/4, 3/8, 1/2, 5/8, 3/4, 7/8
SWAGING TOOL SETS	
S4000	1/4, 3/8, 1/2, 5/8
S5000	1/4, 3/8, 1/2, 5/8, 3/4
S6000	1/4, 3/8, 1/2, 5/8, 3/4, 7/8

Part code	Description
FLARING HEADS, INCHES	
F1014	1/4"
F1516	5/16"
F1038	3/8"
F1012	1/2"
F1058	5/8"
F1034	3/4"
F1078	7/8"
SWAGING HEADS, INCHES	
S1014	1/4"
S1516	5/16"
S1038	3/8"
S1012	1/2"
S1058	5/8"
S1034	3/4"
S1078	7/8"

Part code	Description
SPIN-CASE-S	Soft Deluxe Case - swaging
SPIN-CASE-F	Soft Deluxe Case - flaring
SPIN-X6000	Swaging / flaring tool set - 1/4", 3/8" & 1/2" in soft case

TUBE CUTTERS - METAL TUBING



HI-DUTY TUBE CUTTERS

For 1/8" to 1-1/8" and 1/4" to 1-5/8" O.D. tubing.

- Enclosed hardened steel, thrust bearing feed mechanism for smoothest cutting action and trouble free operation.
- Unique design eliminates spiraling for clean right angle cuts. Our high precision machining and construction method permits one-piece screw-type axle for easy access to cutter wheel – no clip to lose or replace.
- Rugged aluminum alloy body designed for handling ease. Body is hand buffed and nickel chrome plated to a high-luster finish.
- Foldaway hardened steel reamer with turned cutting edge removes inside burrs cleanly. Filing surface removes outside burrs.
- Rollers feature flare cut-off groove to reduce tube loss when damaged flare is removed.
- Imperial® cutter wheels are made of the highest quality wear and abrasion-resistant chromium steel and precision machined to exacting specifications for accurate cutting and long life. Each tool is supplied with a spare cutter wheel.
- All Imperial tube cutters are 100% factory tested to ensure accurate spiral-free cutting.



TC-1000

- TC-1000** For 1/8" to 1-1/8" (4 mm to 28 mm) O.D. tubing. Includes (2) S75015 general purpose cutter wheels. Length 5". Wt. 8.8 oz.
- TC-1010** For 1/8" to 1-1/8" (4 mm to 28 mm) O.D. tubing. Includes (2) S75046 cutter wheels for continuous cutting of stainless steel, monel and other hard-temper tubing. Length 5". Wt. 8.8 oz.
- TC-1020** Combination tube constrictor & tube cutter. For 1/8" to 1-1/8" (4 mm to 28 mm) O.D. tubing. Includes S76637 constrictor wheel and S75015 general purpose cutter wheel. Length 5-1/2". Wt. 8.8 oz.
- 312-FC** For 1/4" to 1-5/8" (7 mm to 41 mm) O.D. tubing. Includes (2) S75015 general purpose cutter wheels. Length 5-1/2". Wt. 10.4 oz.
- Conforms to Federal Specification GGG-C-771d, Type II, Class I.

- S75015** General purpose cutter wheel.
- S75046** Wheel for continuous cutting of stainless steel, monel and other hard temper tubing. For cutters TC-1000, TC-1010, TC-1550, TC-1560, 312-FC, 174-F, TC-2050 and TC-3050.
- S16003162** Replacement cutter wheel for soft copper & aluminum tubing is extra sharp to minimize burr buildup.
- S76637** Constrictor wheel for producing sweat joints.



TC-1010

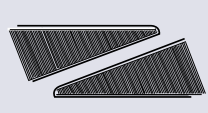
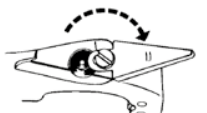
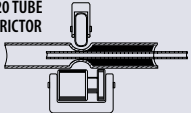

312-FC

 <p>FLARE CUT-OFF GROOVE Groove in rollers reduces tube loss when cracked flare is removed.</p>	 <p>FOLDAWAY REAMER Hardened steel reamer with turned cutting edge removes inside burrs cleanly. Filing surface removes outside burrs.</p>	 <p>SPARE CUTTING WHEEL Spare cutter wheel carried under foldaway locking reamer.</p>	 <p>TC-1020 TUBE CONSTRICTOR FILL WITH SOLDER Joint is ready for sweating when constricted tube contacts smaller tube. Can be used for crimping applications.</p>
---	--	---	--

JUNIOR TUBE CUTTER

For 1/8" to 3/4" (4 mm to 19 mm) O.D. tubing.

- 227-FA** Includes S32633 general purpose cutter wheel. Swing radius 2". Length 3-1/2". Wt. 5.0 oz.



227-FA

IMP MINI TUBE CUTTERS

For 1/8" to 5/8", 3/16" to 7/8" and 1/8" to 1-1/8" O.D. tubing.

- Big capacity, small size tube cutters designed for use in tight quarters where other cutters won't fit.
- Enclosed feed screw minimizes contamination assuring continued smooth operation.
- Corrosion-resistant steel rollers positioned at bottom of cutter allow for easier cutter engagement on tubing and smoother cutting action.
- All Imperial® tube cutters are 100% factory tested to ensure accurate spiral-free cutting.

TC-1050 For 1/8" to 5/8" (4 mm to 15 mm) O.D. tubing. Includes (1) S32633 general purpose cutter wheel. Swing radius 1-1/4" (1-3/8" swing radius with 5/8" tube). Length 1-3/4". Wt. 2.5 oz.

S32633 General purpose cutter wheel for TC-1050.

S26883 Screw for TC-1050 cutter wheel.

TC-2050 For 3/16" to 7/8" (5 mm to 22 mm) O.D. tubing. Includes (1) S75015 general purpose cutter wheel. Swing radius 1-11/16". Length 2-1/4". Wt. 4.0 oz.

TC-3050 For 1/8" to 1-1/8" (4 mm to 28 mm) O.D. tubing. Includes (1) S75015 general purpose cutter wheel. Swing radius 2-1/2" (2-1/16" swing radius with 1-1/8" tube). Length 3". Wt. 7.0 oz.

S75015 General purpose cutter wheel.

S74762 Screw for TC-3050 cutter wheel.

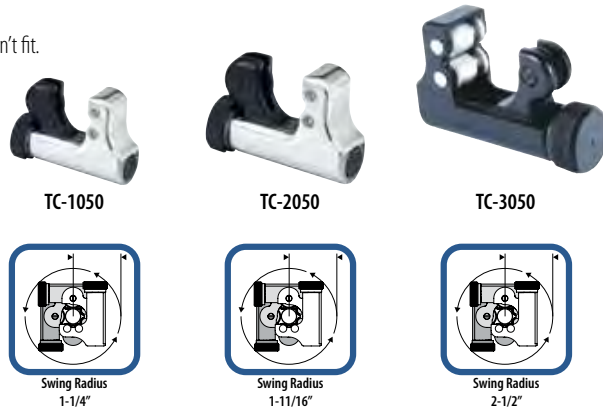

IMP MINI TUBE CUTTERS

For 1/8" to 5/8" and 1/8" to 1-1/8" O.D. tubing.

- Easily completes a full revolution, maximizing leverage.
- Cutter can easily be removed from the handle.
- Ergonomic handle with non-slip grip.
- Six independent drive pawls provide 15° arc-swing.
- Includes (1) general purpose cutter wheel.

TC-1050RH For 1/8" to 5/8" (4 mm to 15 mm) O.D. tubing. 2-Pc. set includes TC-1050 "IMP"® mini tube cutter and ratcheting handle in clamshell packaging. Length 5". Wt. 6.0 oz.

TC-1051 Ratcheting handle only. Length 5". Wt. 1.5 oz.

TC-3050RH For 1/8" to 1-1/8" (4 mm to 28 mm) O.D. tubing. 3-Pc. set includes TC-3050 "IMP"® tube cutter, removable deburr tool and ratcheting handle in clamshell packaging. Length 7". Wt. 11.5 oz.

TC-3051 Ratcheting handle and deburr tool. Length 7". Wt. 4.0 oz.



BIG IMP TUBE CUTTER

For 3/8" to 1-1/8" (10 mm to 28 mm) O.D. tubing.

174-F Includes (2) S75015 general purpose cutter wheels. Swing radius 1-15/16" (2-1/4" swing radius with 1-1/8" tube). Length 2-11/16". Wt. 5.0 oz.

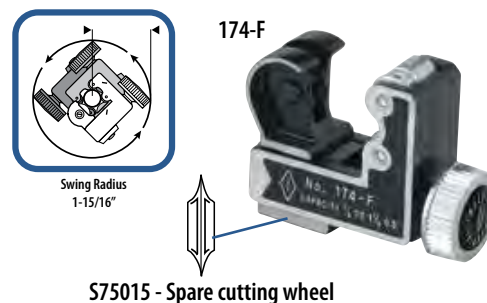

TUBE CUTTERS - METAL TUBING



ADJUST-O-MATUC TUBE CUTTERS

For 3/8" to 2-5/8" and 2" to 4-1/8" O.D. tubing.

- Ratchet feed mechanism speeds up cutting operation.
- Extra wide rollers with flare cut-off groove stabilize tubing.
- Spare cutting wheel included under handle cap.
- Enclosed screw-type feed mechanism; lightweight aluminum alloy body.

206-FB For 3/8" to 2-5/8" (10 mm to 66 mm) O.D. tubing. Includes (2) S74761 general purpose cutter wheels. Length closed 7-3/4". Wt. 2.0 lbs.

406-FA For 2" to 4-1/8" (51 mm to 104 mm) O.D. tubing. Includes (2) S74833 general purpose cutter wheels. Length closed 11-1/4". Wt. 3.5 lbs.

Conforms to Federal Specification GGG-C-771d, Type II, Class I.



406-FA

206-FB

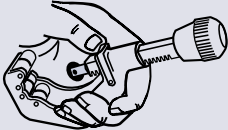
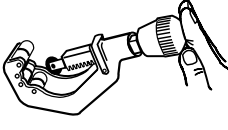
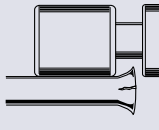
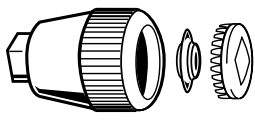
 <p>RATCHET FEED Ratchet release opens cutter instantly to maximum size.</p>	 <p>RATCHET FEED Push on handle to slide cutter wheel to tubing. Rotate handle for fine adjustment.</p>	 <p>FLARE CUT-OFF GROOVE Wide flare cut-off groove in rollers to accommodate flares on large size tubing.</p>	 <p>SPARE CUTTING WHEEL Spare cutter wheel included in handle under snap-off cap.</p>
--	---	--	---

ADJUST-O-MATUC TUBE CUTTERS

For 1/8" to 4-1/8" O.D. tubing.

Selling Imperial® replacement cutter wheels, reamer blades and fasteners is easy. Our Service Center organizes a popular selection of replacement parts for Imperial cutters. Display on the counter or bring it with you when making sales calls.

- 15 most common replacement parts stocked in one handy container.
- Includes a visual replacement chart for quick and easy identification.



144-F

144-F SERVICE CENTER INCLUDES:

PART NO.	QUANTITY	DESCRIPTION	CUTTER
S75015	10	General Purpose Cutter Wheel	TC-1000, TC-1010, 312-FC, 174-F, TC-2050, TC-3050
S75046	5	Cutter Wheel for Stainless Steel	TC-1000, TC-1010, 312-FC, 174-F, TC-2050, TC-3050
S32633	10	Cutter Wheel	TC-1050, 227-FA
S74761	5	Cutter Wheel	206-FB, 206-FBP
S74762	5	Cutter Wheel Retaining Screw	TC-1000, TC-1010, 312-FC, 174-F, TC-2050, TC-3050
S74833	3	Cutter Wheel	406-FA
S26883	3	Cutter Wheel Retaining Screw	TC-1050
S77511	3	Cutter Wheel Retaining Screw	206-FB, 206-FBP
S74834	3	Cutter Wheel Retaining Screw	406-FA
S76637	3	Constrictor Roller Wheel	TC-1000, TC-1010, TC-1020, 312-FC
S16003162	5	Cutter Wheel for Soft Copper Only	TC-1000, TC-1010, 312-FC, 174-F, TC-2050, TC-3050
S10000770	3	Cutter Wheel for PVC	206-FB, 206-FBP
S7931801	3	Reamer Blade	TC-1000, TC-1010, 312-FC
S8201501	3	Retaining Screw for Reamer Blade	TC-1000, TC-1010, 312-FC
S74197	3	Spring Washer for Reamer Blade	TC-1000, TC-1010, 312-FC
144-FB	1	Container only	

SPRING TYPE TUBE BENDERS

For soft copper and aluminum tubing.
For 1/4" to 7/8" O.D. tubing.

Tools allow hand bending of soft tubing to any shape without collapsing walls. Special spring steel, zinc finish. End belled for quick tube removal.



- 201-F Set of 8 benders for 1/4", 5/16", 3/8", 7/16", 1/2", 5/8", 3/4" and 7/8" O.D. tubing.
- 101-F Set of 6 benders for 1/4", 5/16", 3/8", 7/16", 1/2" and 5/8" O.D. tubing.
- 163-F Set of 4 benders for 1/4", 3/8", 1/2" and 5/8" O.D. tubing.
- 112-F Set of 3 benders for 1/4", 5/16" and 3/8" O.D. tubing.

PART NO.	TUBE O.D. (in.)	LENGTH (in.)	WEIGHT EACH (oz.)
102-F-04	1/4	10	3
102-F-05	5/16	10	3
102-F-06	3/8	10	4
102-F-07	7/16	12	6.25
102-F-08	1/2	12	6.5
102-F-10	5/8	12	8
102-F-12	3/4	12	10
102-F-14	7/8	12	10

Each tool bends only one size.

OIL PUMPS & ADAPTERS KITS

CHARGE-OIL PUMP

It charges without pumping the compressor down thus reducing charging time by over 70%. Also avoids the embarrassment of spilling oil on the customer's premises. Provides the professional touch since oil can be accurately measured into the compressor without having to pour it from the can. Fits all popular brands of refrigeration oil.

Complete Adapter Kit supplied to accommodate most containers. The Charge-Oil Pump cap seals the can so pump need not be removed until can is empty. The piston type high pressure pump is designed to operate at pressures to 250 PSI. Pumps one quart in 20 full strokes of the piston. Pump is connected to compressor by refrigerant charging line or copper tubing from 1/4" male fitting. Suitable for use with alkybenzene and POE oils.

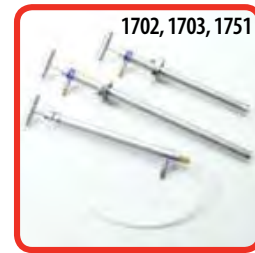

PART NO.	DESCRIPTION
1702	Charge-Oil Pump
1703	Charge-Oil Pump for 5 Gallon Can

CHANGE-OIL PUMP 1751

1751 Change-Oil Pump is a companion to the 1702 Charge-Oil Pump. It has been designed for use in pumping oil from refrigeration compressors, marine engines, and other equipment where it is impossible to drain oil in the conventional manner. Removing oil from refrigeration compressors before dehydrating with vacuum is a necessity. Suction tube is 5/16" OD semi-rigid plastic, 15" long. Suction tubes up to 60" long can be used if necessary. Will not pump under pressure. Pumping capacity about 10 strokes per quart.

ADAPTERS & REPAIR KITS		
PART NO.	NAME	DESCRIPTION
1705	1702 & 1703 Repair Kit	Complete set of gaskets, bearings, rings, springs and washers for the repair of Imperial-Thermal oil pumps
1751RK	1751 Repair Kit	Complete set of gaskets, bearings, rings, springs and washers for the repair of Imperial-Thermal oil pumps
1768	Adapter Kit	Adapter kit for all popular cans and bottles of refrigerant oil. Kit contains 5 rings and one spacer to accommodate most oil containers
1770	Adapter Kit	Suction adapter for aluminum Charge-Oil Pump. Converts part no. 1702 Charge-Oil Pump into suction pump for refrigeration, marine and other similar applications where it is impossible to draw oil in the normal manner

TUBE BENDERS

470-FH TRIPLE HEAD 180° TUBE BENDER WITH ROTO-LOK INDEXING HANDLE

- Bends 3/16", 1/4", 5/16" and 3/8" O.D. tubing.
- Patented, quick-action indexing lever repositions two-stage handle midway through bend when both handles begin to meet. This feature allows easy fabrication of bends up to 180° with reduced effort, better control and no crossing of handles!
- Optimum bending radius – for each tubing size.
- Calibrated markings – for making accurate left-hand, right-hand and offset bends.
- Compact design for working in tight spaces.
- Cushion grips – for comfort and stability.
- Made of lightweight, die-cast aluminum.

TUBE O.D. (in.)	RADIUS TO CENTER OF TUBE (in.)
3/16	9/16
1/4	9/16
5/16	11/16
3/8	15/16



Patented Roto-Lok™ Indexing Lever - Smooth, tight 180° bends with less effort and improved control

Lightweight die-cast aluminum

Bends 3/16", 1/4", 5/16" and 3/8" O.D. tubing

Deluxe cushion grips for comfort and stability

PATENTED

Fixed tube hook

470-FH

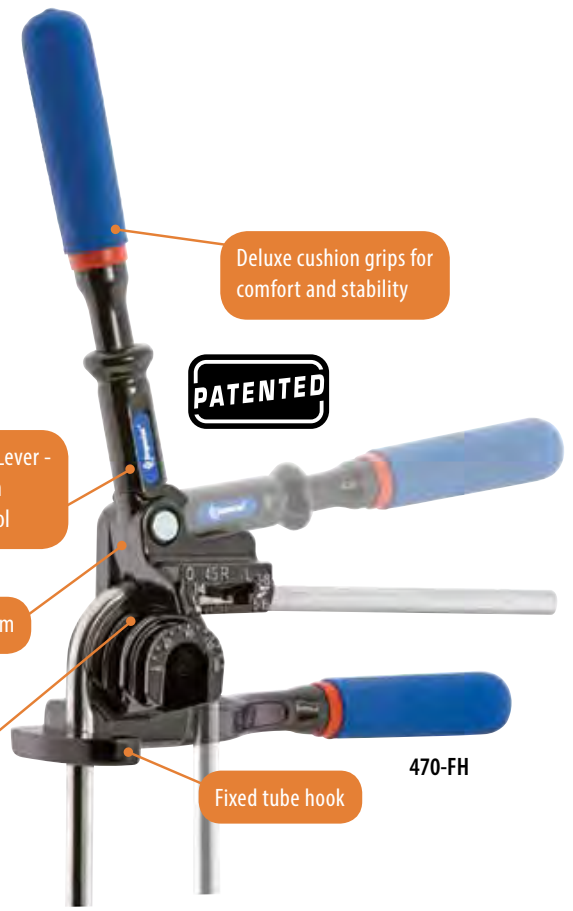

PULL TRIGGER TO RELEASE HANDLE

370-FH TRIPLE HEAD 180° TUBE BENDER

- Bends 3/16", 1/4", 3/8" and 1/2" tubing.
- Makes smooth, tight-radius 180° bends.
- Calibrated markings - for making accurate left-hand, right-hand and offset bends.
- Adjustable hook.
- Optimum bending radius - for each tubing size.
- Cushion grips - for extreme comfort.
- Made of lightweight die-cast aluminum.

PATENTED



370-FH

Bend 3 of the most popular sizes of soft copper, aluminum and thin wall steel tubing with one rugged, precise tool!

TUBE O.D. (in.)	RADIUS TO CENTER OF TUBE (in.)
3/16	11/16
1/4	11/16
3/8	1-1/8
1/2	1-1/2



Easy 180° bends in one swift motion

IMP TRIPLE HEAD BENDERS

- Bends soft copper, aluminum and thin wall steel tubing.
- Bends 1/8", 3/16", 1/4", 5/16", and 3/8" tubing.
- Makes smooth, tight-radius 90° bends.
- Calibrated markings - for making accurate left-hand, right-hand and offset bends.
- 90° start requires less effort – making bending fast and easy.
- Made of lightweight die-cast aluminum.

367-FH For 1/8", 3/16" and 1/4" (3 mm, 4 mm and 6 mm) O.D. tubing. Wt. 0.5 lbs.

368-FH For 3/16", 1/4", 5/16" and 3/8" (6 mm and 8 mm) O.D. tubing. Wt. 1.0 lbs.



367-FH



368-FH

367-FH

TUBE O.D. (in.)	RADIUS TO CENTER OF TUBE	
	(in.)	(mm)
1/8	5/8	16
3/16	19/32	15
1/4	9/16	14

368-FH

TUBE O.D. (in.)	RADIUS TO CENTER OF TUBE	
	(in.)	(mm)
3/16	1-1/64	26
1/4	1-1/64	26
5/16	1	25
3/8	15/16	24

LEVER/SWIVEL TUBE BENDERS



364-FHA LEVER TYPE TUBE BENDERS

For 1/8" to 1" and 6 mm to 12 mm O.D. tubing.

Each tool bends one size. Open-side type which slips over tube at any point. Makes smooth, tight radius bends up to 180° with minimum effort. No scoring or flattening of tubing. Calibrated to show angle of bend. Wide hook grips tubing securely.

364-FHA-14
Features telescopic handles for increased leverage. Expandable style furnished for 7/8" and 1" O.D. tubing.

PART NO.	TUBE O.D. (in.)	RADIUS TO CENTER OF TUBE (in.)	WEIGHT EACH (lbs.)
364-FH-02	1/8	3/8	0.5
364-FH-03	3/16	7/16	0.5
364-FHA-04	1/4	9/16	1.0
364-FHA-05	5/16	11/16	1.0
364-FHA-06	3/8	15/16	1.75
364-FHA-08	1/2	1-1/2	3.5
364-FHA-10*	5/8	2-1/4	5.5
364-FHA-12*	3/4	3	7.0
364-FHA-14*	7/8	3	10.5
364-FHA-16*	1	3-1/2	10.5

Each tool bends only one size.

Conforms to Federal Specification GGG-B-191a Type III, Class 2.

* For bending annealed copper and aluminum tubing only.



364-FHA-06

Style for 1/4" through 1/2" and 6 mm to 12 mm O.D. tubing.

METRIC SIZE BENDING TOOLS

PART NO.	TUBE O.D. (mm)	RADIUS TO CENTER OF TUBE		WEIGHT EACH	
		(mm)	(inches)	(kg.)	(lbs.)
364-FHAM-6MM	6	14.2	9/16	0.45	1.0
364-FHAM-10MM	10	24.0	15/16	0.79	1.75
364-FHAM-12MM	12	38.1	1-1/2	1.6	3.5

Each tool bends only one size.



364-FH-02

Style for 1/8" and 3/16" O.D. tubing.



364-FHA-10

Style for 5/8" and 3/4" O.D. tubing.

364-FHB SWIVEL HANDLE TUBE BENDERS

For 1/4" to 1/2" and 6 mm to 12 mm O.D. tubing.

The 364-FHB series has a swivel handle that can be repositioned midway through a bend when both handles begin to meet. This simple feature allows easy fabrication of bends up to 180° with reduced effort, better control and without the crossing of handles, typical of most other lever type benders.

PART NO.	TUBE O.D. (in.)	RADIUS TO CENTER OF TUBE (in.)	WEIGHT EACH (lbs.)
364-FHB-04	1/4	9/16	1.0
364-FHB-05	5/16	11/16	1.0
364-FHB-06	3/8	15/16	1.75
364-FHB-07	7/16	1-1/2	3.5
364-FHB-08	1/2	1-1/2	3.5

Each tool bends only one size.

Conforms to Federal Specification GGG-B-191a Type III, Class 2.

METRIC SIZE BENDING TOOLS

PART NO.	TUBE O.D. (mm)	RADIUS TO CENTER OF TUBE		WEIGHT EACH	
		(mm)	(inches)	(kg.)	(lbs.)
364-FHBM-6MM	6	14.2	9/16	0.45	1.0
364-FHBM-8MM	8	17.5	11/16	0.45	1.0
364-FHBM-12MM	12	38.1	1-1/2	1.6	3.5

Each tool bends only one size.



364-FHB-06

Style for 1/4" through 1/2" and 6 mm to 12 mm O.D. tubing.

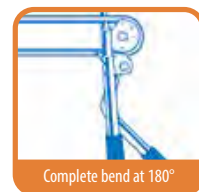
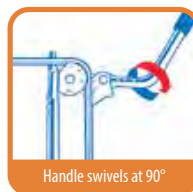
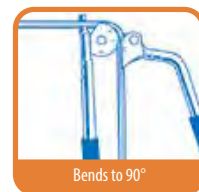
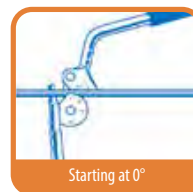

GRABBER ROL-AIR 45° FLARING TOOL

Universal application. Adjustable opening holds all sizes.

Flares and burnishes 3/16" to 5/8" (4.75 mm to 16 mm) O.D. tubing.

525-F Unique, self-adjusting, tube holding mechanism permits flaring any size tubing within the range of 3/16" to 5/8" (4.75 mm to 16 mm) O.D. Innovative, single-opening design is more compact and easier to use than conventional multi-opening flaring bars. Faceted, hardened steel, chrome finished cone rolls out and burnishes perfect 45° flare above the tube-holding mechanism reducing need for deburring. Original wall thickness is maintained at base of flare. Slip-on self-centering yoke permits use in tight quarters. Large handle, with better leverage, and precision threads on feed screw make flaring effortless. High quality construction with satin chrome and black finish. Wt. 1.75 lbs.



525-F

Outside Tube Diameter	(in.)	3/16	1/4	5/16	3/8	1/2	5/8
Wall Thickness	(in.)	.028	.035	.035	.035	.035	.035

Outside Tube Diameter	(mm)	4.75	6	8	10	12	15	16
Wall Thickness	(mm)	1.0	1.0	1.0	1.0	1.0	1.0	1.0



Flares rolled out above die bar by super-smooth faceted cone. Makes stronger flares.

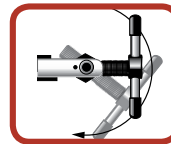

Unique detention mechanism for rapid engagement and release of die blocks.

- (1) Insert tubing into adjustable opening of tube-holding assembly. Position end of tubing approximately 1/8" above the surface of holder.
- (2) Tighten clamp screw approximately 1/2 to 3/4 of a turn beyond free travel position to secure tubing.
- (3) Be certain flaring cone surface is oiled. Slip yoke over tube-holding assembly centering on tubing. Twist yoke clockwise to lock in position. Turn yoke handle clockwise to flare.

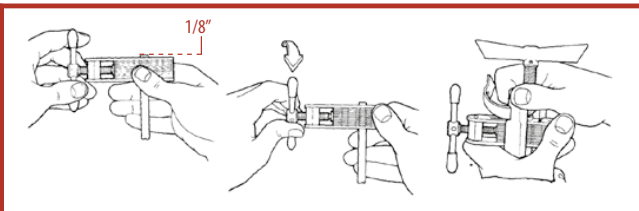

37° FLARING TOOL

For 3/16", 1/4", 5/16", 3/8", 1/2" and 5/8" O.D. tubing.

437-FB For use with soft copper, aluminum and brass tubing. Hardened steel, chrome finished cone makes exceptionally smooth, high-strength flares with a radius at base of flare – instead of the sharp angle formed by ordinary tools. Slip-on yoke permits use in tight quarters, allows flaring where there is little space between nut and tube end. New feed screw design provides smooth, easier operation. Positive gripping and self-gauging of tube for exact flare size. Sliding die blocks lock in place by clamp action. Satin chrome and black finish. Wt. 1.75 lbs.



437-FB

Outside Tube Diameter	(in.)	3/16	1/4	5/16	3/8	1/2	5/8
Wall Thickness	(in.)	.032	.032	.032	.032	.035	.035



FORMS STRONGER FLARES- Stronger flares assured by smooth, even radius formed at base of every flare by engineered chamfer.



SELF GAUGING- Just insert tube flush with top of die for accurate flare size.

FLARING AND SWAGING



45° FLARING TOOL

For 3/16", 1/4", 5/16", 3/8", 7/16", 1/2" and 5/8" O.D. tubing.

195-FC Flares 7 sizes of tubing. Rugged forged steel slip-on yoke and hardened flaring bar. Positive clamping action of bars prevents tube slippage. Self-centering yoke with swivel-type, hardened steel, chrome finished flaring cone forms better flares with less effort. Design of yoke permits flaring where there is little space between nut and tube end. Satin finish nickel chrome plated. Wt. 2.0 lbs.

Outside Tube Diameter	(in.)	3/16	1/4	5/16	3/8	7/16	1/2	5/8
Wall Thickness	(in.)	.028	.035	.035	.035	.035	.035	.035

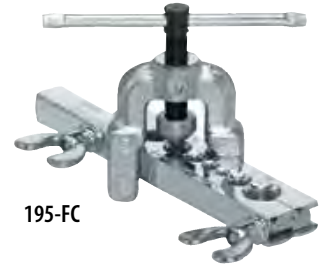

195-FC

45° LARGE SIZE FLARING TOOL

Flares larger tube sizes. Quick slip-on yoke with hardened steel, chrome finished swivel flaring cone reduces effort. Positive clamping action of flaring bar eliminates tube movement. Nickel chrome finish.

Conforms to Federal Specification GGG-F-451a Type 1, Class 2, Style A.

203-FA For sizes 5/8", 3/4", 7/8" and 1-1/8" O.D. tubing. Wt. 3.75 lbs.

375-FS For sizes 1/8", 3/16", 1/4", 5/16", 3/8", 7/16", 1/2", 5/8" and 3/4" O.D. tubing. Includes tool case. Wt. 3.75 lbs.

Outside Tube Diameter	(in.)	1/8	3/16	1/4	5/16	3/8	7/16	1/2	5/8	3/4	7/8	1	1-1/8
Wall Thickness	(in.)	.025	.028	.035	.035	.035	.035	.035	.049	.049	.049	.058	.058



SELF GAUGING - Just insert tube flush with top of die for accurate flare size.



FORMS STRONGER FLARES- Stronger flares assured by smooth, even radius formed at base of every flare by engineered chamfer.

45° ROL-AIR FLARING TOOLS

Flares and burnishes 3/16", 1/4", 5/16", 3/8", 1/2" and 5/8" O.D. tubing.

500-FC Faceted, hardened steel, chrome finished cone rolls out perfect 45° flares above die block, and automatically burnishes flare face reducing the need for deburring. Original wall thickness is maintained at base of flare. Slip-on yoke permits use in tight quarters, where there is little space between nut and tube end. Larger handle, with better leverage, and precision threads on feed screw make flaring effortless. Heat treated dies grip tubing without scoring. Satin chrome and black finish. Wt. 1.5 lbs.

Outside Tube Diameter	(in.)	3/16	1/4	5/16	3/8	1/2	5/8
Wall Thickness	(in.)	.028	.035	.035	.035	.035	.035



Flares rolled out above die bar by super-smooth faceted cone. Makes stronger flares.

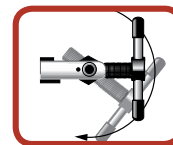

Unique detention mechanism for rapid engagement and release of die blocks.



500-FC

WORKS WITH R-410A

175-EX XPANDER SWAGING/EXPANDER KIT

- Easily expands tube for braze or soldered joints in seconds.
- Floating jaw head design is self-centering for fast, accurate alignment.
- Re-rounds deformed tube ends.
- Accurate joints in seconds without using fittings.
- For soft copper and soft thin wall steel and stainless steel tubing.
- Save 60-70% of time over conventional swaging tools.
- Reduces soldering by 50% over standard fittings.
- Meets ARI tube insertion recommendations.
- Long life with high alloy hardened steel jaw segments.
- XpandR™ Tool comes with non-slip, ergonomically designed grips.
- Includes 5 heads: 3/8", 1/2", 5/8", 3/4" and 7/8".
- Includes metal tool case.



175-EX



SIX EASY STEPS:

1. Deburr inside of tube.
2. To create perfectly centered capillary sockets for soldering or brazing, you must use soft copper or fully anneal end of tube to be expanded.
3. Pull XpandR™ handle up to 90-degree position. Maintain this position as you screw the appropriate size head over the center-punch and tighten.
4. Insert the end of the tube over the XpandR™ head completely.
5. Pull the lever completely down.
6. Return the lever to the 90-degree position. Remove expanded tube.

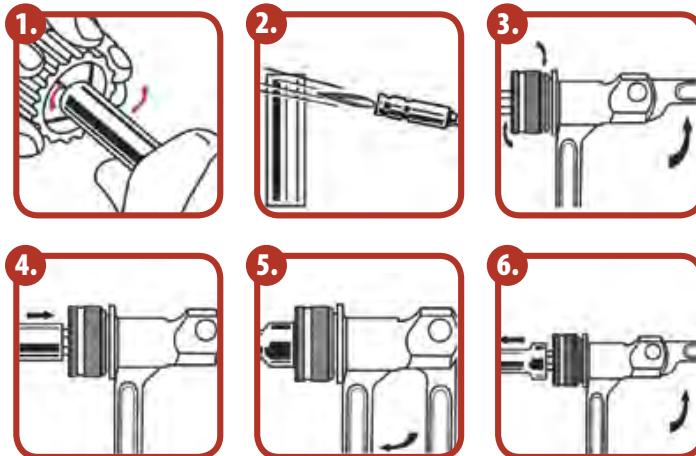

175-EX KIT INCLUDES	
175EXP	XpandR™ Pliers
175EXC	XpandR™ Case
175EX06	3/8" head
175EX10	5/8" head
175EX12	3/4" head
175EX14	7/8" head
You may order kit items separately. Kit wt. 20 lbs.	
ADDITIONAL HEAD SIZES AVAILABLE:	
175EX16	1" head
175EX18	1-1/8" head
175EX22	1-3/8" head
175EX26	1-5/8" head

TO RE-ROUND SLIGHTLY DEFORMED TUBE ENDS:

1. Insert deformed tube end to the first groove of head.
2. Pull the lever completely down.
3. Return the lever to the 90-degree position. Remove expanded tube.

FLARING AND SWAGING



FLARING (45°) AND SWAGING TOOL

For 1/8" to 3/4" O.D. tubing.

275-FS Flares and swages. Converts quickly. Screw-type feed. Ideal for use in close quarters. Two bars included cover 9 sizes. Swivel-type swaging adapters and flaring cone are hardened steel, chrome finished for easy operation. Self-centering, slip-on forged steel yoke. Includes tool case. Wt. 3.5 lbs. Flares 1/8", 3/16", 1/4", 5/16", 3/8", 7/16", 1/2", 5/8" and 3/4" O.D. Includes 5 swage adapters for 7 tube sizes: 3/16", 1/4", 5/16", 3/8", 1/2", 5/8", 3/4" O.D.

Replacement parts: **278-FS-03X04X06** Adapter 3/16", 1/4", 3/8". **278-FS-10** Adapter 5/8". **278-FS-12** Adapter 3/4". **S38600** Flaring Cone.



275-FS

Outside Tube Diameter (in.)	1/8	3/16	1/4	5/16	3/8	7/16	1/2	5/8	3/4
Wall Thickness (in.)	.020	.028	.035	.035	.035	.035	.035	.035	.035



275-FS

45° FLARING, DOUBLE FLARING AND SWAGING TOOL

For 1/8" to 3/4" O.D. tubing.

275-FSD Same as 275-FS with the addition of 5 double flaring adapters (3/16", 1/4", 5/16", 3/8", 1/2" O.D.).

45° FLARING, SWAGING AND CUTTING KIT

For soft copper, aluminum, steel, stainless steel and brass tubing.

275-FSC Kit contains a TC-1000 tube cutter for 1/8" to 1-1/8" O.D. tubing and 275-FS 45° flaring and swaging tool. Includes tool case. Wt. 3.0 lbs.

Flares: 1/8", 3/16", 1/4", 5/16", 3/8", 7/16", 1/2", 5/8" and 3/4" O.D. tubing.

Swages: 3/16", 1/4", 5/16", 3/8", 1/2", 5/8" and 3/4" O.D. tubing.



45° DOUBLE FLARING, SWAGING AND CUTTING KIT

275-FSCD Kit contains 275-FS, TC-1000, and double flaring adapters for 3/16", 1/4", 5/16", 3/8" and 1/2" O.D. tubing. Includes tool case.

PREMIUM TOOL RANGE

PROMAX[®]



 **BOSCH**



ROBINAIR



TIF



RELY ON THE BEST!

DIVERSITECH[®]
INTERNATIONAL 

TESTING AND SERVICE TOOLS



PINCH-OFF TOOL

For 1/4" to 1/2" O.D. tubing.

Temporarily closes soft copper, aluminum or steel tubing so no liquid or gas passes sealed part. Lets you disconnect line while making repairs without loss of liquid or gas. Forming holes for 1/4", 5/16", 3/8" and 1/2" O.D. tubing.

105-FF Pinch-Off Tool for 1/4", 5/16", 3/8" and 1/2" O.D. tubing. Wt. .75 lbs.



TUBING TEST PLUGS

For 1/4" to 1-3/8" O.D. tubing.

For temporary shut-off of tubing without pinching it off or installing a valve. Especially handy for plumbing, heating, refrigeration and instrumentation when troubleshooting for leaks. Lightweight, fast acting, dependable. Insert plug in tube end and tighten wing nut. Expander seals tube and holds pressures to 100 PSI.

142-F 3-Pc. test plug kit for 1/2", 5/8" and 7/8" O.D. tubing. Wt. .5 lbs.



INDIVIDUAL TEST PLUGS

PART NO.	TUBE O.D. (in.)	MIN I.D. DIA. (in.)	MAX I.D. DIA. (in.)	WEIGHT EACH (oz.)	REPLACEMENT SLEEVE
140-F-04	1/4	.171	.190	.5	S62641
140-F-06	3/8	.265	.315	.75	S62648
140-F-08	1/2	.390	.436	1.0	S62655
140-F-10	5/8	.515	.545	1.5	S62661
140-F-12	3/4	.640	.745	2.0	S62666
140-F-14	7/8	.734	.995	3.0	S66434
140-F-18	1-1/8	.984	1.245	4.0	S66435
140-F-22	1-3/8	1.218	1.270	4.0	S71174

WRENCHES

WRENCHES

For Refrigeration and Air Conditioning Service.

127-C Compressor access valve wrench. Chrome plated. Has 1/4", 3/8", 3/16" and 5/16" square drive ratchets and is specially designed for use on compressors with access valves in hard to reach places. Reversible ratchets.

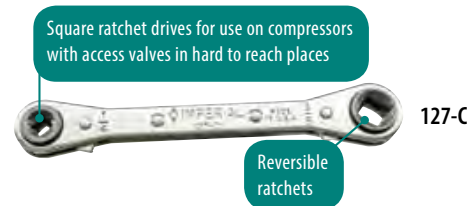

127-C0 Same as 127-C except with unique 25° offset that provides additional convenience in hard to reach places.



124-C Combination wrench with the four sizes most needed for servicing air-conditioning and refrigerator equipment:

- 9/16" hex for dust cap on access valves and plug oil check on compressor.
- 1/2" hex for compressor mounting bolts.
- 1/4" square for valve stem and service valves and old style compressor valves.
- 3/16" square for valve refrigerant charging tanks.



TUBE DEBURRING

DEBURRING TOOL

210-F The rotary style blade is perfect for removing burrs from holes and edges. Large ergonomic handle reduces user fatigue. Ships complete with two heavy duty blades - extra blade stores inside the handle. For copper, steel, aluminum, zinc, cast iron, brass and plastic tubing. Length 5-3/4". Wt. 1.5 oz.



210-F

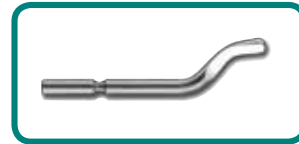

S10001087 - Deburr Replacement Blade

INNER-OUTER REAMING AND DEBURRING TOOL

For 3/16" to 1-1/2" (5 mm to 38 mm) O.D. tubing.

Reams both inside and outside edges of tube at a 60° included angle with 3 hardened cutting blades. Tough die cast body. Deburrs both clockwise and counterclockwise. Fluted body is shaped to fit comfortably in palm.

208-F Reamer for copper, aluminum and brass tubing. Hardened steel cutter blades. Blue finish. Wt. .63 lbs.

208-FSS Reamer for aircraft grade stainless steel tubing, hard or soft copper, aluminum, brass and steel tubing. Tungsten hardened tool steel cutter blades. Black finish. Wt. .63 lbs.

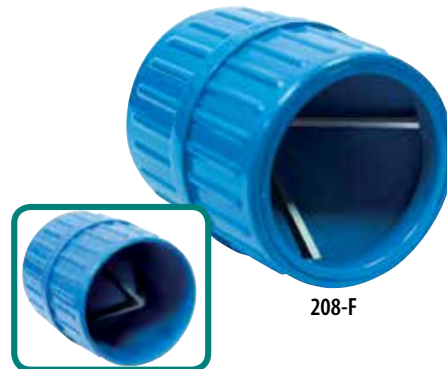

TOOL BAGS

15-POCKET PROFESSIONAL TOOL BAG

TB-52 Tool Bag

- 8" W x 16" L x 11" D.
- Double layered ballistic nylon.
- Wide opening mouth.
- Padded handles and 48" shoulder strap.
- Designed to hold tools.
- Tools not included!

TB-52



COMBINATION TOOLS



- (6) upfront, precision-ground stripping stations for solid and stranded wire.
- Wire cutter.
- (6) screw sizing and cutting stations.
- Wire terminal and 7-8 mm automotive ignition crimp stations.
- Highly visible, easy-to-read graphics.
- Cushion grips.

5-IN-1 COMBINATION TOOLS

- IE-110**
- Strips: 22/20/18/16/14/12/10 AWG.
 - Crimps insulated and non-insulated: 22-18, 16-10 AWG; non-insulated: Auto 7 & 8 mm.
 - Screw cutter: 4-40 / 5-40 / 6-32 / 8-32 / 10-32 / 10-24.
 - Wire sizes, etc., are embossed in metal and paint-filled.
 - Serrated pliers nose for pulling and looping wire.
 - Air-pocket cushion grips.
 - Available in AWG, metric or combination AWG/metric models.
- IE-112**
- Combination Metric/AWG.
- IE-114**
- Metric version.

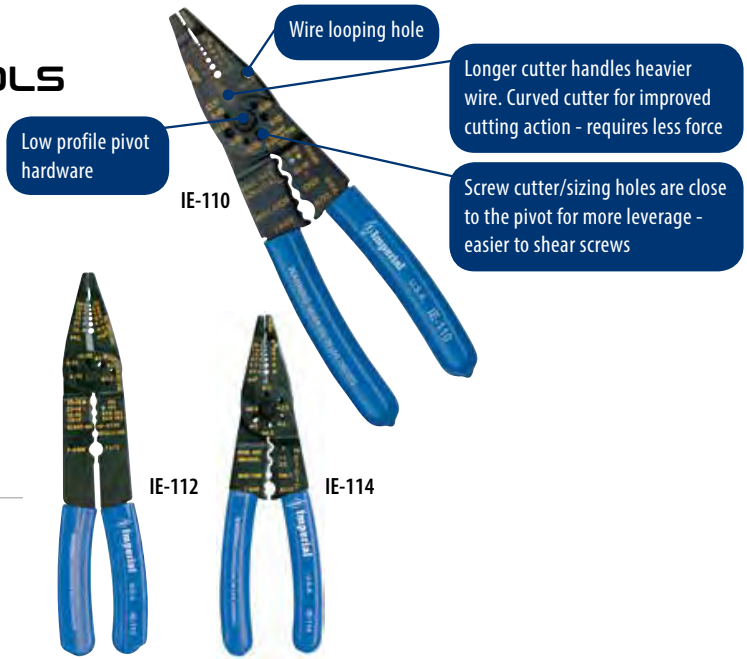

UPFRONT CUTTER / CRIMPER / STRIPPER

- IE-136**
- Curved cutter reduces force required to cut; longer blade length of cutting NM-B cable in a single stroke.
 - Screw cutter/sizing holes are moved closer to the pivot for more making it easier to shear screws.
 - Strips: 10-22 AWG.
 - Crimps: insulated 10-22 AWG.
 - Crimps: non-insulated 10-22 AWG, 7-8 mm Auto.
 - Screw cutter: 4-40 / 6-32 / 8-32 / 10-32 / 10-24.
 - Anvil-type wire cutter at nose of pliers.
- IE-135**
- Anvil-type wire cutter at nose of pliers.
 - Insulated and non-insulated crimp stations.
 - Screw sizing and cutting stations.

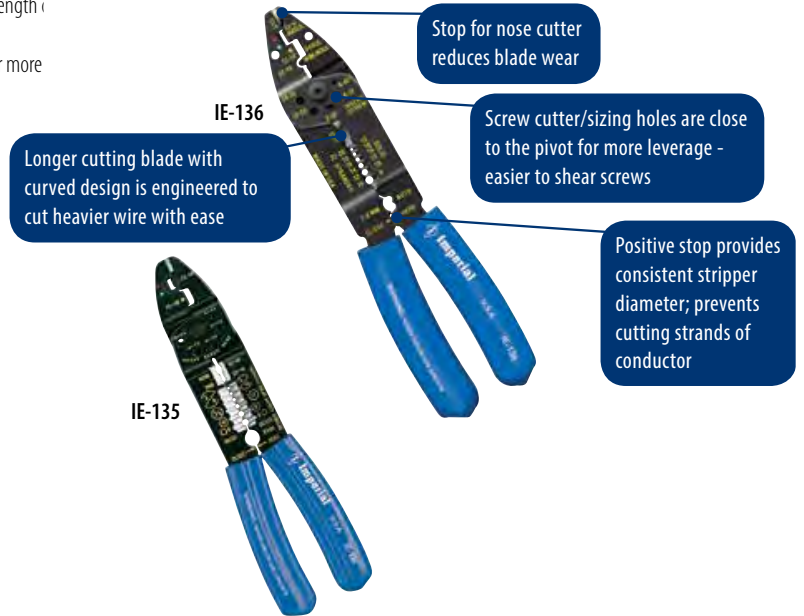

Conforms to ASME Standard B107.500-2010

PART NO.	DESCRIPTION	STRIPPER SIZE (AWG)	CUTTER TYPE	CRIMPS INSULATED (AWG)	CRIMPS NON - INSULATED (AWG)	SCREW CUTTER	NOM. LENGTH (in.)
IE-110	Super 5-in-1 Combination	10-22	Curved-long	10-22	10-22 7-8 mm Auto	4-40 / 5-40 / 6-32 8-32 / 10-32 / 10-24	8-1/4
IE-112	Combination Metric/AWG	10-20, 0.75-6.0 mm ²	Straight	10-22	10-22 7-8 mm Auto	6-32 / 8-32 / 10-32 3.5/4.0/5.0 mm	9-1/2
IE-114	Metric	0.75-6.0 mm ² , 10-22	Straight	1.5-6.0 mm 10-22	1.5-6.0 mm, 10-22 7-8 mm Auto	2.5/3.0/3.5/4.0/ 4.5/5.0 mm	8-1/4
IE-135	Crimper/Cutter with 6 Strip Stations	10-22	Anvil	10-22	10-22, 7-8 mm Auto	4-40 / 6-32 / 8-32 / 10-32 / 10-24	8-3/4
IE-136	Upfront Cutter/Crimper Stripper	8-18 Solid 10-22 Stranded	Anvil Curved-long	10-22	10-22, 7-8 mm Auto	4-40 / 6-32 / 8-32 / 10-32 / 10-24	8-1/2

HOSE SHUT-OFF ADAPTORS

The Kwik-Coupler® adapter set is intended for use with refrigeration and air-conditioning service hoses when connecting to core valve type access fittings. Conventional threaded connecting is converted to push-pull operation which is faster, easier and positive sealing at all times. Valve cores are depressed automatically without adjustments or loss of refrigerant. Disconnecting is also accomplished without loss of refrigerant.

An automatic shut-off valve retains refrigerant pressure in a disconnected hose. This feature permits transferring high side hose refrigerant through the service manifold into the low side, thereby eliminating waste and hazardous high pressure discharge and atmospheric damage.

Features

- Automatic full depression of core valves without adjustment, regardless of core position.
- Coupler halves separately connect to access fitting and hose end, then easy push/pull operation automatically opens or closes system without loss of refrigerant.
- Automatic shut-off of hose ends permits discharging high side hose through manifold into low side.
- Eliminates hazardous discharge of refrigerant and oil from system when disconnecting hose.
- Simplifies operation of charging critical amount of refrigerant into small systems.
- Prevents finger burn when disconnecting - especially servicing heat pumps in cold weather.
- Core depressors in hose ends no longer necessary - speeds servicing of systems with hand valves.

- 16-C** Straight Coupler (45° Flare) 1/4" female x 1/4" male.
- 17-C** 90° Elbow Coupler (45° Flare) 1/4" female x 1/4" male.
- 18-C** (Set) includes 16-C and 17-C.
- 26-C** Straight Coupler (45° Flare) 5/16" female x 5/16" male.
- 27-C** 90° Elbow Coupler (45° Flare) 5/16" female x 5/16" male.

WORKS WITH R-410A

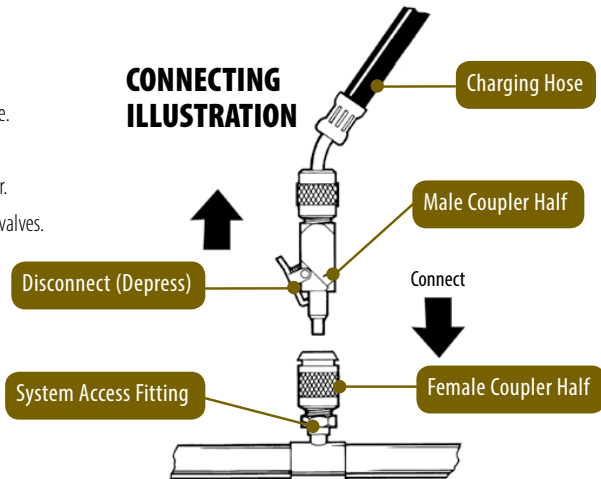
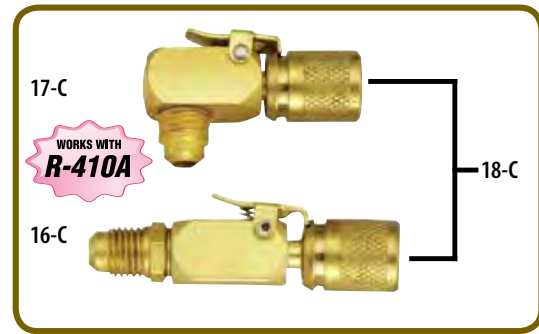

WARNING: Do not allow any refrigerant cylinder, connected for charging, to be exposed to system high side pressure cylinder - explosion could result!

AUTOMOTIVE KWIK-COUPLER ADAPTOR FOR R-12

- 20-A** High side adapter. Converts 3/16" system access valve to 1/4" access valve for use with standard 1/4" charging hose.



HI-DUTY SHUT-OFF COUPLER

- Coupler captures refrigerant within hose, eliminating refrigerant loss, atmospheric damage and finger burns.
- Connects quickly & easily to any standard 1/4" SAE refrigerant hose.
- Solid brass construction for years of dependable service.
- Innovative modular design permits easy field repairs.

SHUT-OFF COUPLER

PART NO.	DESCRIPTION
24-C	90 Degree 1/4" SAE Shut-Off Coupler
25-K	Coupler Service Kit



INSTALLING

ACCESSORIES

ASHP SOAK-AWAY

This unique pre-bagged geo textile soakaway is used to safely dispose of the condensate from all domestic sized air source heat pumps where drain routing is not available. The volume of condensate created from an air source heat pump up to 16kW can be between 10-15 litres per hour up to 2000 litres per year. This method prevents the condensate from flowing onto paths and driveways, which can freeze and cause a slip hazard.



- Alternative method to condensate removal disposal
- Suitable for all models/brands of air source heat pumps
- Made from pre-bagged geo-textile material to prevent soil ingress
- 32mm inlet
- Capacity - 10-15 litres per hour
- Helps with MIS 3005 compliance and complies with BRE 365



1. Identify route of condensate drain from ASHP and best location for position of soakaway.

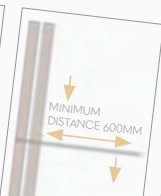

2. Soakaway should be at least 600mm from the wall to avoid causing damp to the footings.



3. Dig a hole minimum 500mm deep x minimum 400mm diameter.



4. Inset the soakaway bag with inlet holes facing the property.



5. For floor-mounted ASHP fit the pipework from the ASHP into the soakaway bag



6. For wall-mounted ASHP fit the pipework from the ASHP into the soakaway bag

Part code	Description	Inlet	Diameter	Height
ASHP-SOAK	Air source heat pump soakaway - pre bagged geo textile with rubber chippings	32mm	400mm	400mm



FIND ME ON
PAGE 100

ACCESS FITTINGS / SWIVEL ADAPTORS

9-C Straight adapter, 1/8" female pipe by 1/4" SAE female swivel connection.



ACCESS VALVES

These valves are designed to facilitate charging and testing of refrigeration systems. Furnished with flare cap on valve end.



Replacement Valve Cores
PART NO. G6400



Wrench Caps
PART NO. G6600



VALVE CORE DEPRESSOR

For 1/4" male flares.

PART NO.	DESCRIPTION
7025	FOR 1/4" MALE FLARES

R-410A BRASS ADAPTOR

Convert new R-410A system ports with 5/16" SAE connections to 1/4" SAE.

WORKS WITH
R-410A



TE-BA01

PART NO.	MALE	FEMALE	OTHER	APPLICATION
TE-BA01	1/4" SAE	5/16" SAE	W/ CORE AND DEPRESSOR	R-410A INTERNATIONAL

R-410A 45° BRASS ADAPTOR

Convert new R-410A system ports with 5/16" SAE connections to 1/4" SAE at 45°.

WORKS WITH
R-410A



TE-BA0145

PART NO.	MALE	FEMALE	OTHER	APPLICATION
TE-BA0145	1/4" SAE	5/16" SAE	W/ CORE AND DEPRESSOR	R-410A INTERNATIONAL

KWIK-COUPLER REPAIR KITS



KWIK COUPLER REPAIR KITS

The Kwik-Coupler® adapter repair kit is intended for use with Imperial® brand 16-C, 17-C, 18-C and 19-C Kwik-Coupler® adapters and PolarShield® KC-Series hose. The male repair kit includes a threaded hex sleeve for replacement on straight coupler assemblies.

KCK-M MALE KWIK COUPLER ADAPTOR REPAIR KIT REPAIRS 2 MALE COUPLERS

Includes: Hex Sleeve (2), Spring (2), Stem Assembly (2) and Sealant

REPAIR INSTRUCTIONS

1. Remove threaded sleeve on end of Kwik-Coupler® adapter. A vise may be necessary to remove old straight sleeve - the 90° has a screwdriver slot on back for removal.
2. Discard old stem and spring.
3. Use a wire brush to clean sealant residue from disassembled parts.
4. Insert new stem and spring.
5. Apply one bead of thread sealant completely around the thread. Do not apply an excessive amount of sealant - this may damage o-ring seal and cause leakage. Assemble to length at right (Fig. 1 & 2). For 90° style, engage threads until the bottom of the slot is even with the back of the coupler (Fig. 4).
6. Allow sealant to cure for at least 30 minutes. The Kwik-Coupler® adapter is now ready to use.

KCK-F FEMALE KWIK COUPLER ADAPTOR REPAIR KIT REPAIRS 5 STANDARD AND 5 AUTOMOTIVE FEMALE COUPLERS (NOT FOR 26-C AND 27-C)

Includes: Retainer (2), Gasket (5), O-Ring (10) and O-Ring 3/16" for Automotive (5)

REPAIR INSTRUCTIONS

1. Insert tapered object (pen or pencil) and press against threaded retainer. Unscrew and remove retainer, sleeve and rubber seals.
2. Lubricate new seals and reassemble. Tighten retainer to zero clearance plus 1/8" turn. The Kwik-Coupler® adapter is now ready for use.

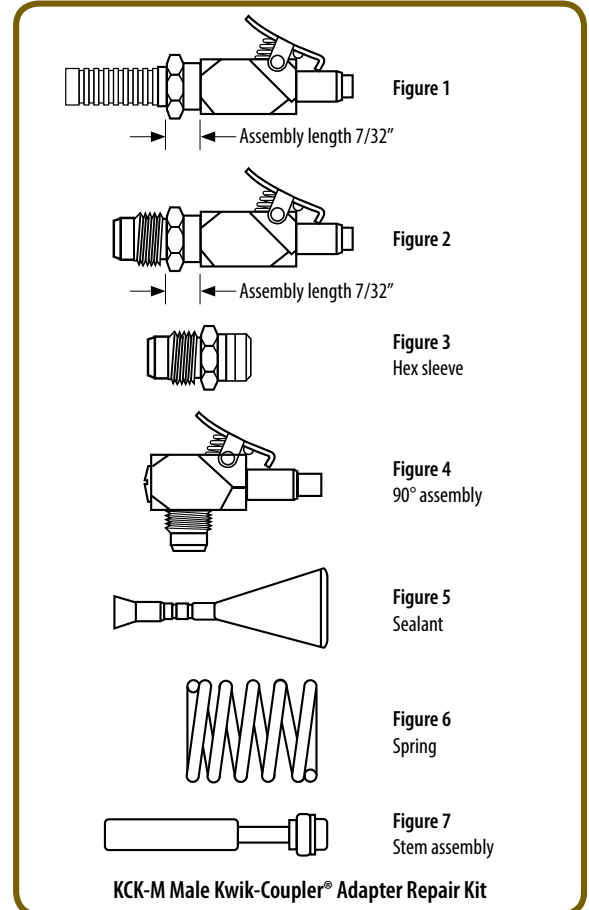

Standard Female Coupler

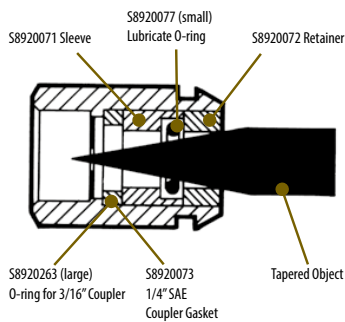

Accessory Side Female Coupler for non-core valve applications

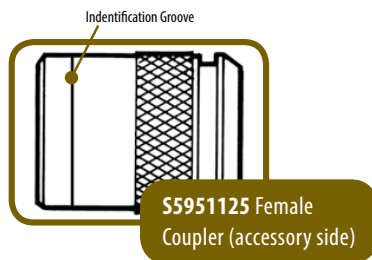
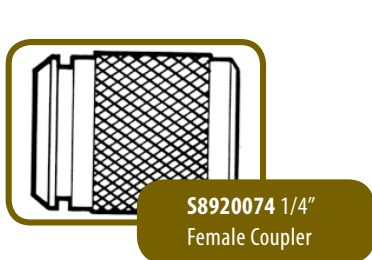
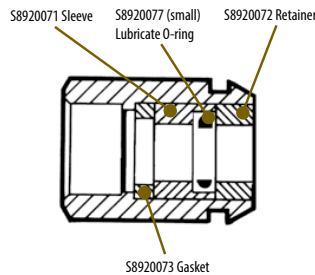

KWIK-COUPLER® ADAPTOR REPLACEMENT PARTS

PART NO.	DESCRIPTION	USED ON
S8920071	Female Coupler 1/4" & 3/16"-Sleeve	16-C, 17-C, 18-C, 19-C
S8920072	Female Coupler 1/4" & 3/16"-Retainer	16-C, 17-C, 18-C, 19-C
S8920073	Female Coupler 1/4"-Gasket	16-C, 17-C, 18-C, 19-C
S8920074	Female Coupler 1/4"-Low Side	16-C, 17-C, 18-C, 19-C
S8920077	Female Coupler 1/4", 3/16" & 5/16"-O-Ring	16-C, 17-C, 18-C, 19-C
S8920263	Female Coupler 3/16"-O-Ring	19-C
S5951125	Female Coupler 1/4"-for Non-Core Valve Application	16-C, 17-C, 18-C, 19-C
KCK-F	Repair Kit For All Female Couplers	
KCK-M	Repair Kit For All Male Couplers	

KWIK-VISE

Refrigerant Recovery Tool

PT-109 Line piercing/refrigerant recovery tool pierces, seals and locks on to copper lines in one swift motion.

Self-adjusting! No need to adjust the tool for different sizes of tubing. The tension system automatically locks pliers on copper tubing 1/4" to 1/2" (6 mm-12 mm) O.D.

To use, simply position the PT-109 on the tubing to be pierced. Close the pliers quickly and firmly. The pliers will automatically adjust and lock into a tightly sealed, secure position.

Features

- Replaceable hardened, stainless steel pierce and brass valve assembly (S16002045).
- Capacity: 1/4" thru 1/2" O.D. refrigerant copper tubing.
- Durable: made with high-carbon, heat treated steel jaws.
- Works with all refrigerants CFC, HFC, HCFC and Zeotropic, Azeotropic.
- 90° elbow valve eliminates tangling and interference problems.

S16002045 Replacement pierce and brass valve assembly.

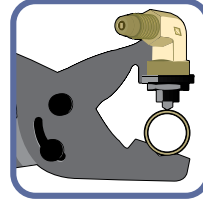

PT-109

KWIK CHARGE

Liquid Low Side Charger

Provides fast, safe charge - essential for today's blended refrigerants!

The Kwik Charge® charging unit accepts liquid refrigerant from the cylinder and discharges into low side of the system. Charging rate is up to eight times faster than vapor charging. In addition, liquid charging is required when using R-410A and other blended refrigerants. Attach the Kwik Charge device to the low side of the charging manifold. Charging hose is connected from Kwik Charge device outlet to low side of refrigeration system. Internal metering element reduces liquid flow to a level below capacity of compressor. This assures a safe, fast charge without endangering the compressor. A built-in ball check valve automatically opens when drawing a vacuum to assure rapid, unrestricted evacuation. Can be used with all fluorinated hydrocarbon refrigerant systems.

Features

- Up to 8 times faster than vapor charging.
- No need to heat refrigerant cylinder.
- Built-in check valve opens for drawing unrestricted vacuum.
- No pressure drop in cylinder.
- One charger services all units 1/2 ton or larger.

535-C Kwik Charge® charging unit 1/4" female SAE flare inlet, 1/4" male SAE flare outlet.



535-C

CONNECTION TO MANIFOLDS
(connect all hoses as usual)

2-Valve Connect Kwik Charge® charger to low side fitting. Arrow downward.

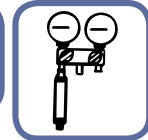

Can be connected to refrigerant cylinder rather than manifold.



4-Valve Unscrew end fitting & reverse, then connect to refrigerant fitting as shown (flow arrow on body points upward).

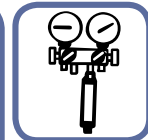

LINE SET BENDER

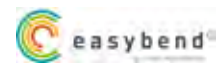

EASYBEND - AIRCO LINE SET BENDER

The "easy" soft copper bend!

Easybend is designed specifically for use as an internal pipe bender to offer the installer a fast, easy and kink and leak-free bend in soft copper linesets. Reusable - just clean it off after use and store in the zip lock bag.

- Bends linesets when installing split systems
- Easiest way to bend twin tubes without damaging their insulation
- Reusable
- No need for springs or heavy equipment
- Only for soft copper



THE PACKAGE

- Red line 
- Green line 
- Yellow line 
- Blue line 

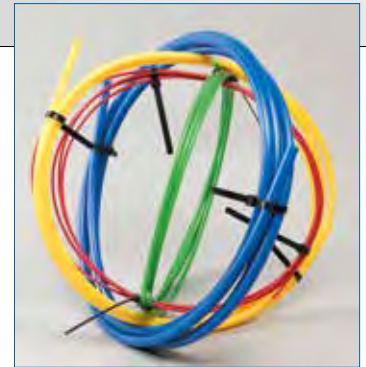

FAST AND EASY INSTALLATION



STEP 1
INSERT THE FLEXIBLE BENDER OF THE RIGHT DIAMETER INTO THE COPPER TUBE.



STEP 2
BEND TO THE REQUIRED ANGLE.



STEP 3
RETRACT THE FLEXIBLE BENDER.



STEP 4
THESE BENDERS ARE REUSABLE IF WIPED CLEAN BETWEEN INSTALLATIONS.



HOW NOT TO USE!

Part code	Colour	Diameter	Length	Qty
EZB (4 colours per set)	Red	6mm (1/4")	4m (13')	15 sets per box
	Green	9mm (3/8")	4m (13')	15 sets per box
	Yellow	12mm (1/2")	4m (13')	15 sets per box
	Blue	16mm (5/8")	4m (13')	15 sets per box

MANIFOLDS



CO₂ MANIFOLDS

RA 411744E300C

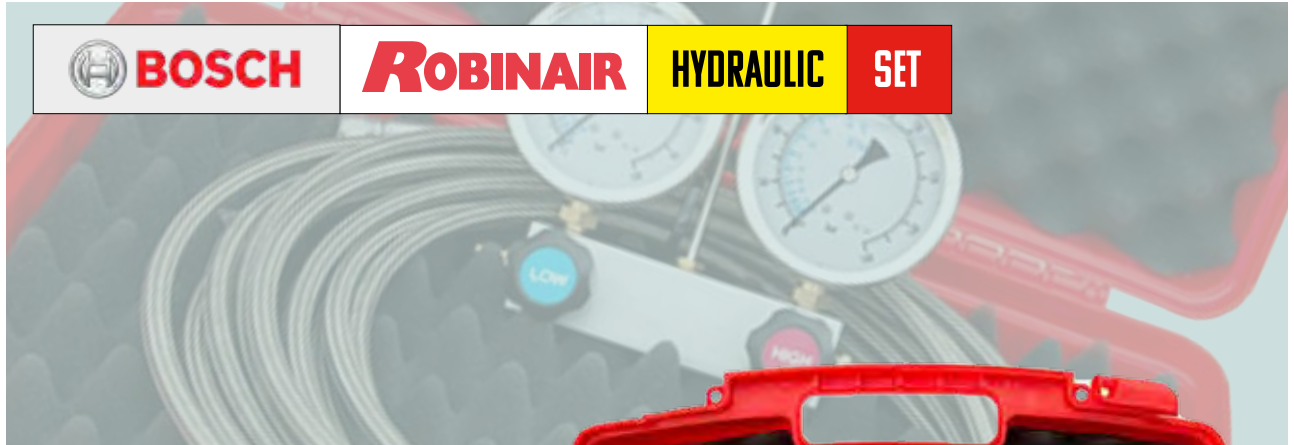

2-WAY MANIFOLD

- 2-Way Manifold
- Available separately or as Set with hoses and carrying case
- Analog gauges ø 80 mm, oil filled, metal casing
- High pressure gauge 1 to 160 bar
- Low pressure gauge -1 to 100 bar
- Hose length 3 m
- Hose connection 1/4" SAE (7/16" UNF)
- PTFE hoses with stainless steel braid
- Working pressure 224 bar (-70 to 230 °C)
- Burst pressure 672 bar



Code	Description	Quantity
RA 411744E300C	Robinair 2-way manifold	1

IMPERIAL - HVAC&R SERVICE MANIFOLDS

Imperial deluxe service manifolds have rugged lightweight bodies, with laser-etched graphics. A proven diaphragm valve design allows finger-touch operation, with just one turn to fully open. Imperial gauges are non-flutter, with high visibility faceplates. Our manifolds also feature large knobs with a soft-touch grip surface. All spare parts are readily available.

DELUXE 4-VALVE

- The 3/8" vacuum port and oversized internal passages allow for 4-times faster evacuation than conventional manifolds
- Deep vacuum diaphragm-type soft-seat valves require only fingertip pressure to close completely or open for full-flow
- Precision class I 80mm gauges provide superior resistance to vibration and pulsation for accurate performance and extended gauge life
- PolarShield® Hi-Performance Hoses (800 PSI/WP, 4,000 PSI/BP) - not all models include hose



Manifold only	36" hoses	60" hoses	72" hoses	Description
IMP-840C-PH	IMP-840C-36-PH	IMP-840C-60-PH	IMP-840C-72-PH	No Sight Glass, 80mm Gauges, Blue Body R410A, R32
IMP-848C-PH	IMP-848C-36-PH	IMP-848C-60-PH	IMP-848C-72-PH	No Sight Glass. 80mm Gauges, Blue Body R134A,R404A,R407C
IMP-849C-PH	IMP-849C-36-PH	IMP-849C-60-PH	IMP-849C-72-PH	No Sight Glass, 80mm Gauges, Blue Body R448A,R449A,R452C

DELUXE 2-VALVE, 4 & 5 PORT

- Precision engineering with dyna1nic full-flow valve design for faster evacuation and charging
- Dual O-ring valve seals for long-life and trouble-free performance
- Precision gauges provide superior resistance to vibration and pulsation for accurate performance and extended gauge life
- Protective gauge boots shield against shock and vibration
- Ergonomic colour-Part coded soft-touch handles.
- PolarShield® Hi-Performance Hoses (800 PSI/WP, 4,000 PSI/BP) - not all models include hose.



(MODEL SHOWN - IMP-560CB) WITHOUT HOOK

Manifold only	36" hoses	60" hoses	72" hoses	Description
IMP-540CB	IMP-540CB-36-PH	IMP-540CB-60-PH	IMP-540CB-72-PH	No Sight Glass. 4 Port 63mm Gauges. Silver Body (with Rubber Boots) R41 O A/R32
IMP-560CB	IMP-560CB-36-PH	IMP-560CB-60-PH	IMP-560CB-72-PH	With Sight Glass, 5 Port 63mm Gauges, Blue Body (with Rubber Boots) R1 34A/R404A/R407C

IMPERIAL - POLARSHIELD HIGH-PERFORMANCE CHARGING HOSES

- Compatible with all I-FC, HCFC & HFO refrigerants.
- Feature 800 PSI working pressure and 4,000 PSI burst pressure with a 5 to 1 safety factor
- Available with a variety of end connections, in yellow, red or blue, individually or in sets of three.



STANDARD HOSE SETS

36" hoses	60" hoses	72" Hoses	Description	Pack qty
IMP-803MRS	IMP-805MRS	IMP-806MRS	1/4" x 1/4" (red, yellow, blue)	Pack of 3
IMP-853MRS	IMP-855MRS	IMP-856MRS	1/4" x 5/16" (red, yellow, blue) R410A/R32	Pack of 3



SINGLE HOSES

36" hoses	60" hoses	72" Hoses	Description	Pack qty
IMP-803MRY	IMP-805MRY	IMP-806MRY	1/4" x 1/4" (yellow)	Single
IMP-803MRR	IMP-805MRR	IMP-806MRR	1/4" x 1/4" (red)	Single
IMP-803MRB	IMP-805MRB	IMP-806MRB	1/4" x 1/4" (blue)	Single
IMP-853MRY	IMP-855MRY	IMP-856MRY	1/4" x 5/16" (yellow) R410A/R32	Single
IMP-853MRR	IMP-855MRR	IMP-856MRR	1/4" x 5/16" (red) R410A/R32	Single
IMP-853MRB	IMP-855MRB	IMP-856MRB	1/4" x 5/16" (blue) R410A/R32	Single



VACUUM HOSES

36" hoses	72" Hoses	Description	Pack qty
IMP-536FTY	IMP-572FTY	3/8" x 3/8" (yellow)	Single



BALL VALVES

Part code	Description	Pack qty
IMP-800MBS	6" low loss ball valve adaptor hose 1/4" x 1/4"	Pack of 3



KWIK-COUPLER ADAPTORS

1/4" F x 1/4" M	5/16" F x 5/16" M	Description	Pack qty
IMP-16C	IMP-26C	Straight coupler (45° Flare)	Single
IMP-17C	IMP-27C	90° Elbow Coupler (45° Flare)	Single

Part code	Description	Pack qty
IMP-18C	Set includes IMP-16C and IMP-17C	Pack of 2
IMP-28C	Set includes IMP-26C and IMP-27C	Pack of 2
20128	1/4" to 5/16" brass adaptor	Pack of 1



HOSE GASKETS

Part code	Description	Pack qty
IMP-S7958301	Hose gaskets for 1/4" hose	Pack of 10
IMP-S7958302	Hose gaskets for 3/8" hose	Pack of 10
IMP-S7958302	Hose gaskets for 5/16" hose	Pack of 10



IMP-S7958301

IMPERIAL SPARES PRECISION REFRIGERANT GAUGES

The replacement gauges have high visibility colour-Part coded refrigerant scales. The unique design isolates the movement from the socket creating a superior shock resistance. The enhanced vibration dampening design cushions the movement for flutter-free performance and extended service life. With a superior pulsation resistance, after 10 million cycles, these gauges show three times less wear than conventional gauges. The result is a longer lasting, more reliable gauge.

63MM (2-1/2")

80MM (3-1/8")



MODEL SHOWN
IMP-420BCKP

MODEL SHOWN
IMP-420BCKP

Part code	Description - 63mm (2-1/2")	Refrigerant	Colour	Pack qty
IMP-406CB	Single gauge 63mm (2-1/2")	R22, R41 0A, R407C - PSI, °C	Blue	Single
IMP-406CR	Single gauge 63mm (2-1/2")	R22, R41 0A, R407C - PSI, °C	Red	Single
IMP-407CB	Single gauge 63mm (2-1/2")	R1 34A, R404A, R407C - PSI, Bar, °C	Blue	Single
IMP-407CR	Single gauge 63mm (2-1/2")	R1 34A, R404A, R407C - PSI, Bar, °C	Red	Single
IMP-408CB	Single gauge 63mm (2-1/2")	R410A - PSI, Bar, °C	Blue	Single
IMP-408CR	Single gauge 63mm (2-1/2")	R410A - PSI, Bar, °C	Red	Single
IMP-420BCKP	Single gauge 63mm (2-1/2")	R134A, R404A, R22 - PSI, KPA. °C / °F	Blue	Single
IMP-420RCKP	Single gauge 63mm (2-1/2")	R134A, R404A, R22 - PSI, KPA. °C / °F	Red	Single
IMP-453CB	Single gauge 63mm (2-1/2")	R41 0A - PSI, kPa, °C	Blue	Single
IMP-453CR	Single gauge 63mm (2-1/2")	R41 0A - PSI, kPa, °C	Red	Single

Part code	Description - 80mm (3-1/8")	Refrigerant	Colour	Pack qty
IMP-406CB	Single gauge 80mm (3-1/8")	R22, R41 0A, R407C - PSI, °C	Blue	Single
IMP-406CR	Single gauge 80mm (3-1/8")	R22, R41 0A, R407C - PSI, °C	Red	Single
IMP-407CB	Single gauge 80mm (3-1/8")	R1 34A, R404A, R407C - PSI, Bar, °C	Blue	Single
IMP-407CR	Single gauge 80mm (3-1/8")	R1 34A, R404A, R407C - PSI, Bar, °C	Red	Single
IMP-408CB	Single gauge 80mm (3-1/8")	R410A - PSI, Bar, °C	Blue	Single
IMP-408CR	Single gauge 80mm (3-1/8")	R410A - PSI, Bar, °C	Red	Single
IMP-420BCKP	Single gauge 80mm (3-1/8")	R134A, R404A, R22 - PSI, KPA. °C / °F	Blue	Single
IMP-420RCKP	Single gauge 80mm (3-1/8")	R134A, R404A, R22 - PSI, KPA. °C / °F	Red	Single
IMP-453CB	Single gauge 80mm (3-1/8")	R41 0A - PSI, kPa, °C	Blue	Single
IMP-453CR	Single gauge 80mm (3-1/8")	R41 0A - PSI, kPa, °C	Red	Single

MANIFOLD REPLACEMENT PARTS

A range of manifold replacement parts are sold in single pack quantities of each item. If you would like more information on our manifolds please contact the sales department on +44(0)115 900 5858.



Part code	Description	Pack qty
IMP-406CB	Rubber Boots Kit - Blue & Red (63mm gauges only) - kit contains 1 x blue and 1 x red	Single
IMP-406CR	Manifold Diaphragm Repair Kit	Single
IMP-407CB	Replacement VAC & REF Knob Kit with Stems - Black and Yellow	Single
IMP-407CR	Replacement HI & LO Knob Kit with Stems - Red and Blue	Single
IMP-408CB	Replacement VAC, REF, HI, LO, Knob Kit with Stem and Diaphragm	Single
IMP-408CR	Replacement Hanging Hook	Single

SERVICE MANIFOLDS PARTS ILLUSTRATIONS



510 AND 520 SERIES 2-VALVE MANIFOLD

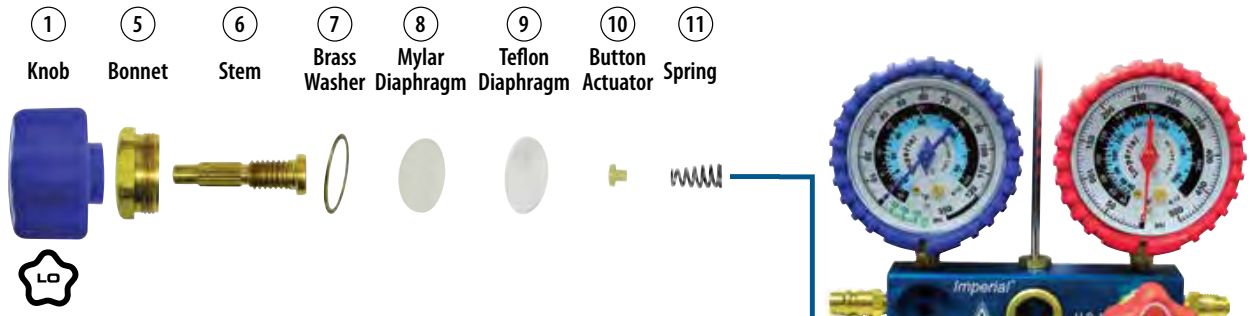
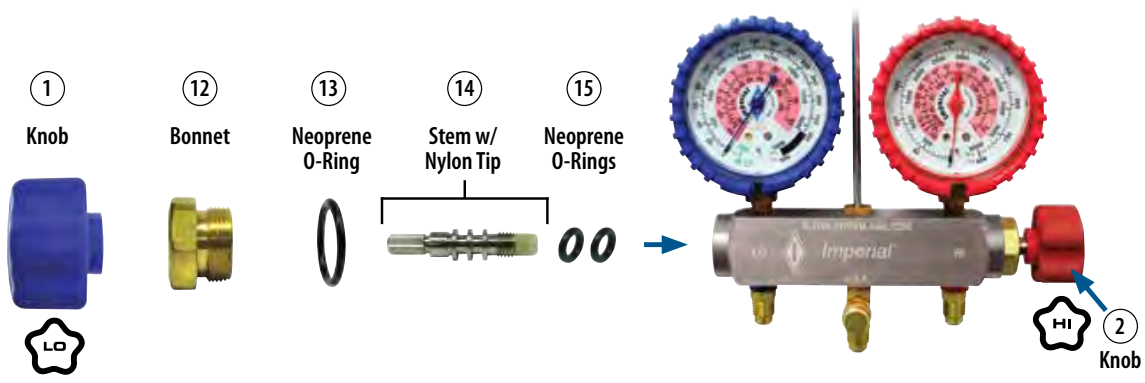

REPLACEMENT PARTS LIST

Part No	1	2	3	4	5	6	7	8	9	10	11	12	13	14	15	16	17	18	19	
10SG																1				
405-RH*				1														1	1	1
405-RL*			1															1	1	1
500-RH*		1										1	1	1	2					
500-RL*	1											1	1	1	2					
600-R							2	2	2	2	2									
602-RK	1	1				2														
S64104									10											
S64108							10													
S64870										10	10									
S69021								10												
S76548					2															

* These kits are shipped completely assembled for quick and easy replacement.

400 AND 300 SERIES 2-VALVE BRASS MANIFOLD

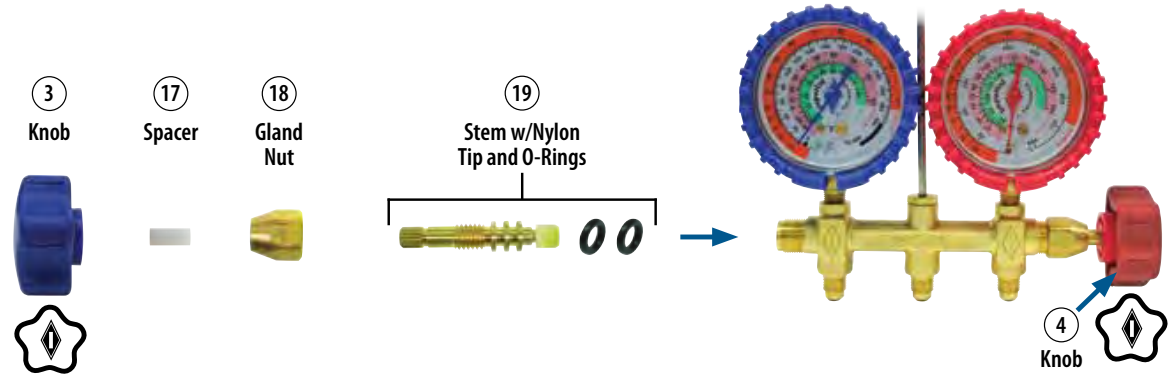

GAUGES & HOSES

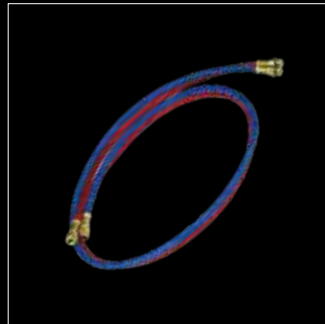

PRECISION REFRIGERANT GAUGES



PRECISION REFRIGERANT GAUGES

WITH HI-VISIBILITY COLOR-CODED REFRIGERANT SCALES

- **Superior Shock Resistance** - Our unique design isolates the movement from the socket, reducing the effects of shock.
- **Superior Vibration Resistance** - Our enhanced vibration dampening design cushions the movement for flutter-free performance and extended gauge service life.
- **Superior Pulsation Resistance** - After 10 million cycles, these gauges show three times less wear than conventional gauges. The result is a longer lasting, more reliable gauge.



Protective rubber boots for 2-1/2" gauges sold separately.

2-1/2" GAUGES

- 1/8" MNPT Connections
- 3 : 2 : 3% Accuracy
- Replacement Screw-on Lens Set- S8230301
- Protective Red & Blue Rubber Boot Set - 400-RB

PART NO.	DESCRIPTION	GAUGE CALIBRATION					TEMP	
		PSI	BAR	Kg/cm ²	kPa	MPa	°F	°C
R-12, R-134a								
441-CB	Blue Compound	●					●	
441-CR	Red Pressure	●					●	
R-12, R-22, R-502								
323-CR	Red Pressure	●					●	
325-CB	Blue Compound	●					●	
405-CB	Blue Compound	●	●				●	●
405-CR	Red Pressure	●	●				●	●
423-CAM	Red Pressure			●			●	●
423-CAPD	Red Pressure					●	●	●
423-CK	Red Pressure				●		●	●
423-CKP	Red Pressure	●			●		●	●
423-CR	Red Pressure	●					●	●
425-CAM	Blue Compound			●			●	●
425-CAPD	Blue Compound					●	●	●
425-CB	Blue Compound	●					●	●
425-CK	Blue Compound				●		●	●
425-CKP	Blue Compound	●			●		●	●
431-CM	Red Pressure	●		●			●	●
432-CM	Blue Compound	●		●			●	●
R-22, R-404A, R-410A								
422-CB	Blue Compound	●					●	●
422-CR	Red Pressure	●					●	●
R-32, R-410A *NEW*								
453-CB	Blue Compound	●			●		●	●
453-CR	Red Pressure	●			●		●	●

PART NO.	DESCRIPTION	GAUGE CALIBRATION					TEMP	
		PSI	BAR	Kg/cm ²	kPa	MPa	°F	°C
R-22, R-407C, R-410A								
406-CB	Blue Compound	●						●
406-CR	Red Pressure	●						●
428-CKP	Blue Compound	●				●		●
429-CKP	Red Pressure	●				●		●
R-22, R-404A, R-507								
426-CKP	Blue Compound	●				●		●
427-CKP	Red Pressure	●				●		●
R-22, R-134a, R-404A								
420-BCKP	Blue Compound	●				●		●
420-RCKP	Red Pressure	●				●		●
424-CB	Blue Compound						●	●
424-CR	Red Pressure	●					●	●
R-134a								
434-BKP	Blue Compound	●				●		●
434-RKP	Red Pressure	●				●		●
R-134a, R-404A, R-407C								
407-CB	Blue Compound	●	●					●
407-CR	Red Pressure	●	●					●
R-134a, R-404A, R-507								
451-CB	Blue Compound	●					●	●
451-CBM	Blue Compound			●	●			●
451-CR	Red Pressure	●					●	●
451-CRM	Red Pressure			●	●			●
R-410A								
2423-P	Red Pressure				●		●	●
2425-CP	Blue Compound				●		●	●
408-CB	Blue Compound	●	●					●
408-CR	Red Pressure	●	●					●
452-CB	Blue Compound	●				●		●
452-CR	Red Pressure	●				●		●

80MM (3-1/8") Class 1 GAUGES *NEW*

- 1/8" MNPT Connections
- 1% Accuracy

PART NO.	DESCRIPTION	GAUGE CALIBRATION					TEMP	
		PSI	BAR	Kg/cm ²	kPa	MPa	°F	°C
R-404A, R-410A, R-22								
404-CB	Blue Compound	●					●	
404-CR	Red Pressure	●					●	
R-22, R-134a, R-404A								
458-CB	Blue Compound	●					●	
458-CR	Red Pressure	●					●	
R-407C, R-410A, R-22								
459-CB	Blue Compound	●					●	
459-CR	Red Pressure	●					●	
R-410A								
460-CB	Blue Compound	●					●	
460-CR	Red Pressure	●					●	

For proper evacuation and dehydration of refrigeration and air-conditioning systems, an electronic vacuum gauge is an indispensable companion to a vacuum pump. Significant dehydration does not occur until a vacuum of 1000 microns or greater has been achieved. Use of electronic vacuum gauges is the only way to determine when dehydration is occurring and when it is complete.

Imperial-Thermal Engineering Vak-Checks are precision thermistor vacuum gauges designed especially for refrigeration and air-conditioning service. They automatically compensate for changes in ambient temperature and permit continuous monitoring during evacuation. These instruments are compact, lightweight, easy to use, and read directly in microns on a large easy-to-read meter.

VAK-CHECK

4501

Features

- Atmosphere to 10 microns.
- Ambient temperature compensated.
- Accuracy: 200-1000 microns: $\pm 5\%$.
- Comes complete with Model 4510 Sensor.
- Battery powered, no searching for outlets (2 "D" cell batteries not included).



SUPER VAK-CHECK II

14571

This analog thermistor vacuum gauge allows you to choose between 110AC and battery as your power source with the same features as the Model 4501.

Features

- AC/battery operated.
- Range: Atmosphere to 10 microns.
- Ambient temperature compensated.
- Complete with Model 4510 Sensor.
- Accuracy: 200-1000 microns $\pm 5\%$.
- Power: 110AC or 2 "D" cell batteries (Batteries not included).



REPLACEMENT VACUUM SENSORS

4510

Features

- Vacuum Sensor for Vak-Check and Super Vak-Check II.
- Models 4501 and 14571 with 0 to 50 calibration scale.



VAK-SCALE

Saving the service technician time and money, Imperial-Thermal Engineering provides the ability to combine digital hand held vacuum gauge technology with strain gauge technology for refrigerant charging.

HANDHELD DIGITAL MICRON GAUGE

4775

Backed by more than 45 years of vacuum technology the 4775 borrows from the old while incorporating advanced new features including (7) units of measure, an LCD backlight, LCD contrast control, and a vacuum minimum/maximum function that stores the last vacuum reading in memory. Lightweight and easy to use, the 4775 will provide the discriminating service technician with a dependable instrument for accurately measuring vacuum in an air-conditioning or refrigeration system.

Features

- Ergonomic durable case.
- Auto shutoff.
- LCD backlight and contrast.
- Multiple units of measure.



HI-PERFORMANCE CHARGING HOSES



POLARSHIELD CHARGING HOSE

950, 900, 850 & 800 SERIES

- **All Imperial® PolarShield® charging hoses are UL recognized** and meet UL-1963, SAE-J2196 & EPA requirements for strength, pressure and refrigerant permeation.
- **Rugged, Multi-Refrigerant Nylon Barrier Construction** - PolarShield hoses are compatible with all CFC, HFC & HCFC refrigerants (R-410A, R-404A, R-407C, R-134a).
- **High-Pressure** - PolarShield hoses feature 800 PSI working pressure and 4,000 PSI burst pressure with a 5-to-1 safety factor.
- **Selection** - PolarShield hoses are available with a variety of end connections, in yellow, red or blue, individually or in sets of three. Consult factory for lengths and end connections not listed below.

WORKS WITH
R-410A

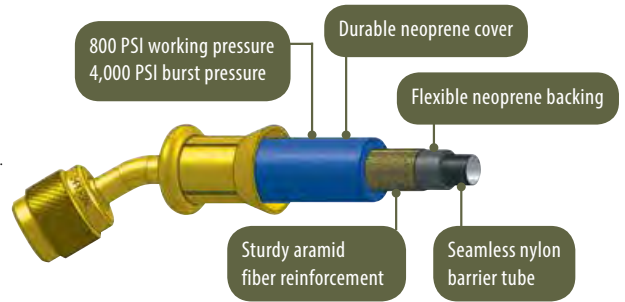

950 SERIES HOSES WITH LOW LOSS BALL VALVE SHUT-OFF AND 1/4" FFL* CONNECTIONS

LENGTH	BLUE	YELLOW	RED	SET OF THREE (B,Y,R)
3' (36")	953-MRB	953-MRY	953-MRR	953-MRS
5' (60")	955-MRB	955-MRY	955-MRR	955-MRS
6' (72")	956-MRB	956-MRY	956-MRR	956-MRS

*5/16" fittings available-contact factory for part numbers

900 SERIES POLARSHIELD HOSES WITH AUTOMATIC SHUT-OFF VALVE

Precision engineered automatic low loss 1/4" FFL* shut-off valve traps refrigerant within the hose to eliminate venting and finger burn.

900 SERIES HOSES - (1/4" FFL* CONNECTIONS WITH AUTOMATIC SHUT-OFF ON ONE END)

LENGTH	BLUE	YELLOW	RED	SET OF THREE (B,Y,R)
3' (36")	903-MRB	903-MRY	903-MRR	903-MRS
5' (60")	905-MRB	905-MRY	905-MRR	905-MRS
6' (72")	906-MRB	906-MRY	906-MRR	906-MRS

*5/16" fittings available-contact factory for part numbers

850 SERIES PolarShield® HOSES FOR R-410A SYSTEMS WITH 5/16" ACCESS FITTINGS (1/4" x 5/16" hose connections)

LENGTH	BLUE	YELLOW	RED	SET OF THREE (B,Y,R)
3' (36")	853-MRB	853-MRY	853-MRR	853-MRS
4' (48")	854-MRB	854-MRY	854-MRR	854-MRS
5' (60")	855-MRB	855-MRY	855-MRR	855-MRS
6' (72")	856-MRB	856-MRY	856-MRR	856-MRS

800 SERIES PolarShield® HOSES WITH STANDARD 1/4" FITTINGS*

LENGTH	BLUE	YELLOW	RED	SET OF THREE (B,Y,R)
3' (36")	803-MRB	803-MRY	803-MRR	803-MRS
4' (48")	804-MRB	804-MRY	804-MRR	804-MRS
5' (60")	805-MRB	805-MRY	805-MRR	805-MRS
6' (72")	806-MRB	806-MRY	806-MRR	806-MRS
8' (96")	808-MRB	808-MRY	808-MRR	808-MRS
12' (144")	812-MRB	812-MRY	812-MRR	812-MRS

*5/16" fittings available-contact factory for part numbers

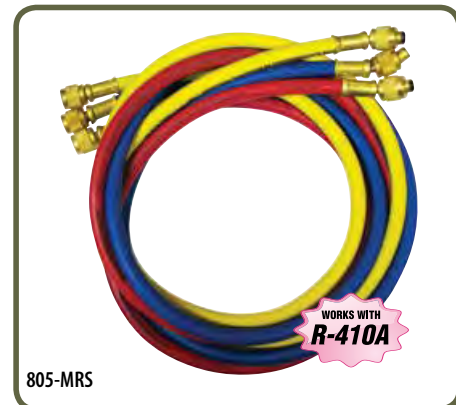
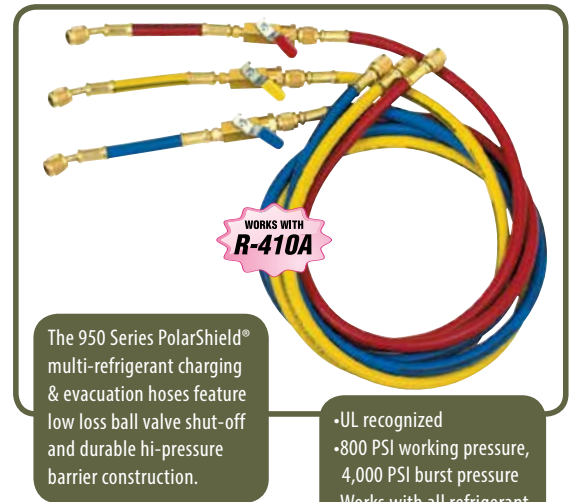

3/8" EVACUATION HOSE WITH 3/8" SAE SWIVEL CONNECTION

For faster evacuation and charging

3/8" hose in four lengths for larger jobs or applications where reduced service time is desired. 3/8" swivel ends. Eight-crimp ferrules. Available in yellow.

LENGTH	YELLOW
3' (36")	536-FTY
4' (48")	548-FTY
5' (60")	560-FTY
6' (72")	572-FTY



6" LOW LOSS VALVE ADAPTOR HOSES

1/4" SAE 45° female x 1/4" SAE male straight fittings

Connects to any 1/4" SAE charging line. Non-restrictive for maximum flow. UL recognized - environmentally safe.



LENGTH	BLUE	YELLOW	RED	SET OF THREE (B,Y,R)
6"	800-MBB	800-MBY	800-MBR	800-MBS

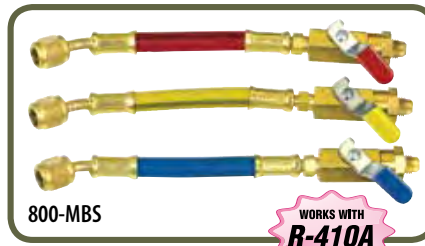

200 SERIES POLARSHIELD HOSE SETS FOR R-410A

(5/16" x 5/16" hose connections)

LENGTH	SET OF THREE (B,Y,R)
3' (36")	203-MRS
5' (60")	205-MRS
6' (72")	206-MRS

800 PSI Working Pressure; 4,000 PSI Burst Pressure

200 SERIES POLARSHIELD HOSE SETS FOR R-410A

B, R - 1/4" x 5/16" hose connections
Y - 1/4" x 1/4" hose connection

LENGTH	SET OF THREE (B,Y,R)
3' (36")	213-MRS
4' (48")	214-MRS
5' (60")	215-MRS
6' (72")	216-MRS

800 PSI Working Pressure; 4,000 PSI Burst Pressure

600 SERIES PREMIUM CHARGING HOSE

(1/4" x 1/4" hose connections)

LENGTH	SET OF THREE (B,Y,R)
3' (36")	603-MRS
5' (60")	605-MRS
6' (72")	606-MRS
12' (144")	612-MRS

600 PSI Working Pressure; 3,000 PSI Burst Pressure

HOSE CONVERSION ADAPTORS

The Imperial-Thermal Engineering conversion adapter consists of a compact ball valve that is ideal for retrofitting standard refrigerant hoses, providing instant refrigerant shut off capabilities. Available in standard 1/4" and 5/16" sizes for R-410A.

PART NO.	DESCRIPTION
TE-BV01R	1/4 SAE X 1/4 F SAE
TE-BV01Y	1/4 SAE X 1/4 F SAE
TE-BV01B	1/4 SAE X 1/4 F SAE
TE-BV01-3	1/4 SAE X 1/4 F SAE, SET OF 3
TE-BV02R	1/4 SAE X 5/16 F SAE
TE-BV02Y	1/4 SAE X 5/16 F SAE
TE-BV02B	1/4 SAE X 5/16 F SAE
TE-BV02-3	1/4 SAE X 5/16 F SAE, SET OF 3



HOSE REPLACEMENT PARTS

- 57958301** 1/4" Hose Seal Gasket.
- 57958302** 3/8" Hose Seal Gasket.
- 58921626** Brass Core Depressor.
- 51000265** 1/2" ACME & 5/16" Hose Seal Gasket.

GET IN. GET OUT. GET ON TO THE NEXT JOB.



Flaring and swaging is a big part of the job. That's why we made a big effort to guarantee you get a precise flare and swage every time. Convenience and comfort both come standard throughout Hilmor's full line of flaring and swaging tools. Simply choose the tool that fits your needs, and get ready to conquer your next job.

HILMOR RANGE

HILMOR RANGE

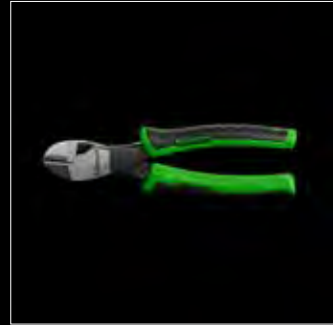



1935917
REFRIGERATION HOSES
WITH BALL VALVE ENDS

REFRIGERATION HOSES WITH BALL VALVE ENDS

Our retooled hoses includes an easy turn valve for added control of refrigerant loss. Features an extra abrasion-resistant layer for superior protection in tough conditions. All of our hoses are rated for 800 PSI working pressure to work with the newest high-pressure refrigerants.



MINIMISE REFRIGERANT LOSS

EASY-TURN VALVE FOR ADDED CONTROL OF REFRIGERANT LOSS



HANDLES HIGH PRESSURE

RATED FOR 800PSI WORKING PRESSURE TO WORK WITH HIGH-PRESSURE REFRIGERANTS



SMALL SPACE CAPABLE

A COMPACT DESIGN ALLOWS IT TO BE USED EVEN IN CRAMPED SPACES

Part code	Description	Diameter	MAX allowable working pressure	Burst pressure	Operating temp	End connection	Weight
1935917	H48BVES3 Set of 3 - 48"	1/4"	800 PSI	4000 PSI	-20° F to 180° F	Straight by 45°	1.8lbs
1935918	H48BVEBV Vacuum - 48"	3/8"	800 PSI	4000 PSI	-20° F to 180° F	Straight by 45°	1.8lbs
1935924	H60BVES3 Set of 3 - 60"	1/4"	800 PSI	4000 PSI	-20° F to 180° F	Straight by 45°	1.8lbs
1935926	H60BVEBV Ball Valve - 60"	3/8"	800 PSI	4000 PSI	-20° F to 180° F	Straight by 45°	1.8lbs



SOFT TUBING ONLY COPPER, STEEL, ALUMINUM, BRASS

COMPACT BENDER KITS

1839032 COMPACT BENDER KIT

Body and crossbar for 1/4" to 7/8", 1/4", 5/16", 3/8", 1/2", 5/8", 3/4" and 7/8" mandrels.

1926598 COMPACT BENDER KIT WITH REVERSE BENDING ATTACHMENT

Body and crossbar for 1/4" to 7/8", 1/4", 5/16", 3/8", 1/2", 5/8", 3/4", 7/8" mandrels and Reverse Bending Attachment.



SIMPLE SETUP

UNIVERSAL CROSSBAR AND COLOR-CODED MANDRELS MAKE IDENTIFYING AND CHANGING SIZES QUICK AND EASY.



ONE-HANDED OPERATION

A RATCHETING MECHANISM AND INNOVATIVE RELEASE LEVER ALLOW FOR BENDING WITH ONE HAND.



SMALL SPACE CAPABLE

A COMPACT DESIGN ALLOWS IT TO BE USED EVEN IN CRAMPED SPACES



A REVERSE BENDING ATTACHMENT FOR BENDS IN THE OPPOSITE DIRECTION.



A RATCHETING LEVER GIVES YOU THE BRAUN TO BEND TUBES WITH ONE HAND.



A QUICK-RELEASE BUTTON ALLOWS YOU TO FREE THE TUBE WITH EASE AND WITHOUT DAMAGE.



A LOCKING SLIDER KEEPS THE BENDER COMPACT FOR STORAGE AND TRANSPORT.

Part code	Description	Tube sizes (O.D.)	Length	Width	Height	Weight
1839032	CBK	1/4", 5/16"	16-3/8"	12-1/4"	3-1/4"	8.8 lbs
1926598	CBKRB	1/4", 5/16"	16-3/8"	12-1/4"	3-1/4"	10.8 lbs

Replacement parts

1890999	CBRBM Rev Bend Att	-	-	-	-	-
---------	--------------------	---	---	---	---	---



SOFT TUBING ONLY COPPER, STEEL, ALUMINIUM, BRASS

TRI-TUBE BENDERS

From start to final bend, the Hilmor Tri-Tube Benders have you covered.



PRECISE ANGLES

CALIBRATED MARKINGS FOR MAKING ACCURATE BENDS UP TO 180°



COMFORTABLE GRIP

NON-SLIP GRIP



LIGHTEN YOUR LOAD

CONSTRUCTED OUT OF LIGHTWEIGHT DIE-CAST ALUMINIUM



INDEXING HANDLE

INDEXING HANDLE COMPACT DESIGN FOR TIGHT ACCESS. (1839026 ONLY)

Part code	Description	Tube sizes (O.D.)	Length	Width	Height	Weight
1839026	TB31638	3/16", 1/4", 5/16", 3/8"	2-1/2"	6"	12-1/2"	1.8 lbs
1839027	TB31612	3/16", 1/4", 3/8", 1/2"	3-1/2"	7-1/2"	7"	2.5 lbs

SPRING BENDERS

Getting an accurate bend by hand isn't always easy. But, our Spring Benders can help simplify things. Four different benders are included to fit 1/4", 3/8", 1/2" and 5/8" tubing. Simply slip the Spring Bender over soft copper or aluminum tubing, and count on the spring to keep the tube from kinking.



Part code	Description	Tube sizes (O.D.)	Length	Weight
1839031	SB 4PC Set	1/4" 3/8" 1/2" 5/8"	11-1/3"	5 oz

TRUNKING

INABA DENKO TRUNKING

FLEXIBLE JOINT



Part code	Description
ID-SF-100-800-I	Slimduct - 100mm - 800mm Flexible Joint - Ivory
ID-SF-100-800-W	Slimduct - 100mm - 800mm Flexible Joint - White
ID-SF-100-800-K	Slimduct - 100mm - 800mm Flexible Joint - Black
ID-SF-100-800-B	Slimduct - 100mm - 800mm Flexible Joint - Brown
ID-SF-75-500-I	Slimduct - 75mm - 500mm Flexible Joint - Ivory
ID-SF-75-500-W	Slimduct - 75mm - 500mm Flexible Joint - White
ID-SF-75-500-K	Slimduct - 75mm - 500mm Flexible Joint - Black
ID-SF-75-500-B	Slimduct - 75mm - 500mm Flexible Joint - Brown

COUPLER



Part code	Description
ID-SJ-100-I	Slimduct - 100mm Connection Piece - Ivory
ID-SJ-100-W	Slimduct - 100mm Connection Piece - White
ID-SJ-100-K	Slimduct - 100mm Connection Piece - Black
ID-SJ-100-B	Slimduct - 100mm Connection Piece - Brown
ID-SJ-75-I	Slimduct - 75mm Connection Piece - Ivory
ID-SJ-75-W	Slimduct - 75mm Connection Piece - White
ID-SJ-75-K	Slimduct - 75mm Connection Piece - Black
ID-SJ-75-B	Slimduct - 75mm Connection Piece - Brown

90° FLAT ELBOW



Part code	Description
ID-SK-100-I	Slimduct - 100mm 90 Degree Flat Bend - Ivory
ID-SK-100-W	Slimduct - 100mm 90 Degree Flat Bend - White
ID-SK-100-K	Slimduct - 100mm 90 Degree Flat Bend - Black
ID-SK-100-B	Slimduct - 100mm 90 Deg Flat Bend - Brown
ID-SK-75-I	Slimduct - 75mm 90 Degree Flat Bend - Ivory
ID-SK-75-W	Slimduct - 75mm 90 Degree Flat Bend - White
ID-SK-75-K	Slimduct - 75mm 90 Degree Flat Bend - Black
ID-SK-75-B	Slimduct - 75mm 90 Deg Flat Bend - Brown

45° FLAT ELBOW



Part code	Description
ID-SKF-100-I	Slimduct - 100mm 45 Degree Flat Bend - Ivory
ID-SKF-100-W	Slimduct - 100mm 45 Degree Flat Bend - White
ID-SKF-100-K	Slimduct - 100mm 45 Degree Flat Bend - Black
ID-SKF-100-B	Slimduct - 100mm 45 Deg Flat Bend
ID-SKF-75-I	Slimduct - 75mm 45 Degree Flat Bend
ID-SKF-75-W	Slimduct - 75mm 45 Degree Flat Bend
ID-SKF-75-K	Slimduct - 75mm 45 Degree Flat Bend
ID-SKF-75-B	Slimduct - 75mm 45 Deg Flat Bend - B

FIND ME ON PAGE 33

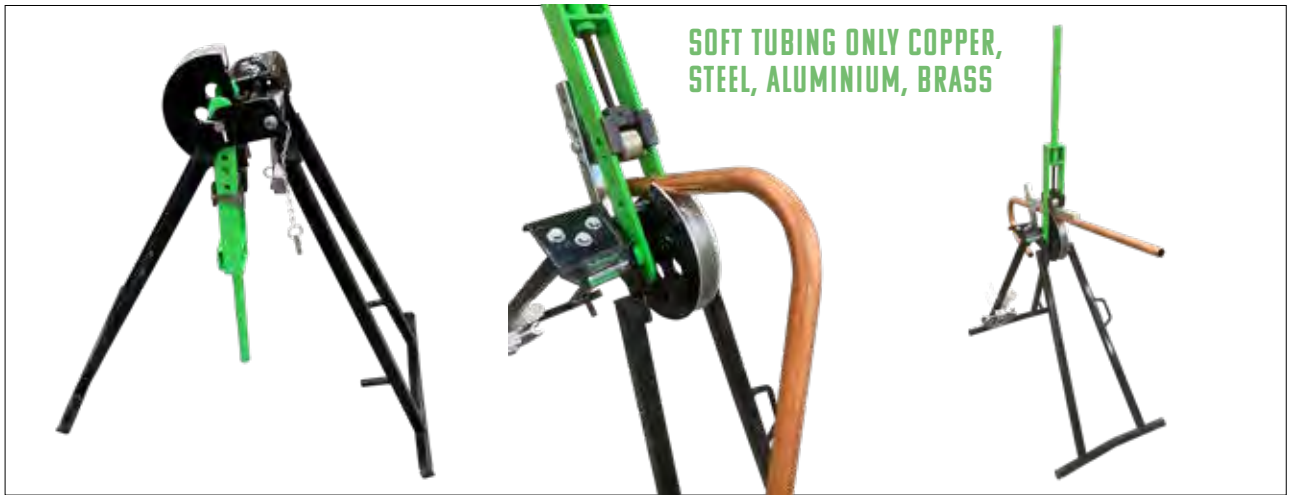

SOFT TUBING ONLY COPPER, STEEL, ALUMINIUM, BRASS

HIL-CM TUBE BENDER

Capacities

CM35

15, 22 & 28mm copper to BS2871.

15, 22, & 28mm mild steel to BS4182.

15, 22 & 28mm stainless steel to BS4127

7/8" & 1-1/8" copper

PRECISE ANGLES

CALIBRATED MARKINGS FOR MAKING ACCURATE BENDS UP TO 180°

COMFORTABLE GRIP

NON-SLIP GRIP

Model	Description
HIL- CM35-MO	CM35 Frame only
HIL-CM35-15 to 28	CM35 Frame 15mm, 22mm and 28mm Former and Guides
HIL-CM35-IMP-7/8 to 1-1/8	CM35 Frame 7/8" and 1-1/8" Former and Guides

Model	Description
HIL- EL25-MO	EL25 Machine and Vice
HIL- EL25-20-25	EL25 Machine, Vice, 20mm and 25mm Formers

Part code	Description
Kits	
HIL-CM35-15-28	A Frame Bender 15, 22 & 28mm formers and guides
HIL-CM35-7/8-1 1/8	A Frame Bender 7/8" & 1 1/8" formers and guides
Parts	
HIL-CM35-15DISC	15mm Former Disc
HIL-CM35-22DISC	22mm Former Disc
HIL-CM35-28DISC	28mm Former Disc
HIL-CM35-7/8DISC	7/8" Former Disc

Part code	Description
Parts	
HIL-CM35-1-1/8DISC	1 1/8" Former Disc
HIL-CM35-15GUIDE	15mm GUIDE
HIL-CM35-22GUIDE	22mm GUIDE
HIL-CM35-28GUIDE	28mm GUIDE
HIL-CM35-7/8GUIDE	7/8" GUIDE
HIL-CM35-1-1/8GUIDE	1 1/8" GUIDE





HIL-GLM-15-22 HAND TUBE BENDER

- Compact bender suitable for copper, stainless steel and mild steel
- Suitable for installation of small heating and refrigeration systems
- A comfortable ergonomic non-slip grip
- Constructed out of lightweight steel for a lighter and easier to carry tool
- 15 mm and 22 mm formers and guides and in the box
- Suitable for 7/8" copper



PRECISE ANGLES
CALIBRATED MARKINGS FOR MAKING ACCURATE BENDS UP TO 180°



COMFORTABLE GRIP
NON-SLIP GRIP



LIGHTEN YOUR LOAD
CONSTRUCTED OUT OF LIGHTWEIGHT DIE-CAST ALUMINIUM

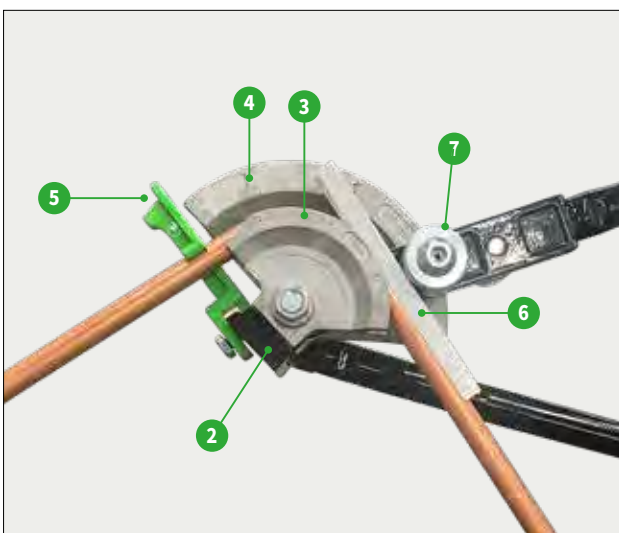

- 1. Swivel arm
- 2. Housing bracket
- 3. 15mm former
- 4. 22mm former
- 5. Tube locator
- 6. Guide
- 7. Roller

Note: For best results ensure that the formers and guides are clean and free from grit or other particles. Keep the swivel arm/pivot bolt/former housing bracket, and the roller studs lubricated.

This machine is designed to bend the materials specified, and should not be used to bend other materials without prior approval of the manufacturer.

Model	Description
HIL-GLM-15-22	HIL-GLM-15-22 hand tube bender





ORBITAL FLARE

The Hilmor Orbital Flare was designed to produce quality flares – again and again. A tube-stop arrow allows precise positioning and placement so you can keep that nickel in your pocket. Plus, a clutch mechanism stops the flare to eliminate cracking the tube.

- 

PRECISE FLARES, EVERY TIME
AN OFF-CENTER MOUNTED CONE SPINS ON AN AXIS TO EFFECTIVELY PRODUCE QUALITY FLARES
- 

NO CRACKED TUBES
A CLUTCH MECHANISM STOPS THE FLARING WHEN THE JOB IS DONE
- 

SIMPLE SETUP
A CLOTHESPIN-INSPIRED, SPRING-LOADED BLOCK GRIPS THE TUBE SECURELY
- 

EASY TO POSITION
A TUBE-STOP ARROW SLIDES TO SET CORRECT HEIGHT AND POSITIONING WHILE BALL DETENTS ALLOW FOR EASY FLARING CONE ALIGNMENT.

Part code	Description	Flare type	Tube sizes (O.D.)	Length	Width	Height	Weight
1838952	FTO	45°	3/16", 1/4", 5/16", 3/8", 1/2", 5/8", 3/4"	8-1/2"	4-5/8"	5-1/4"	3.8 lbs



SOFT TUBING ONLY COPPER, STEEL, ALUMINIUM, BRASS

KIT CONTENTS:
1 BAR, 1 QUICK-ENGAGE YOKE, 1 FLARE CONE 3/16" TO 3/4", 5 SWAGE HEADS

QUICK-ENGAGE FLARE AND SWAGE KIT

Extra appendages are hard to come by these days. Instead, opt for the all-new Hilmor Quick-Engage Flare and Swage. Simple setup, precise positioning and a secure hold allow you to quickly conquer and move on to the next job.



LESS WORK

ALLOWS FOR FASTER FLARES AND SWAGES BECAUSE IT REQUIRES FEWER ROTATIONS



SIMPLE SETUP

A CLOTHESPIN-INSPIRED, SPRING-LOADED BLOCK GRIPS THE TUBE SECURELY



EASY TO POSITION

A TUBE-STOP ARROW SLIDES TO SET CORRECT HEIGHT AND POSITIONING WHILE BALL DETENTS ALLOW FOR EASY FLARING CONE ALIGNMENT.



BALL DETENTS ENSURE PROPER AND PRECISE ALIGNMENT TO GUARANTEE A PERFECT FLARE OR SWAGE EVERY TIME.



PUSH DOWN THE YOKE AND WITH FEWER ROTATIONS, YOU GET A PRECISE FLARE OR SWAGE.



AN INNOVATIVE SPRING-LOADED BLOCK HOLDS THE TUBE FIRMLY IN PLACE.

Part code	Description	Flare type	Tube sizes (O.D.)	Length	Width	Height	Weight
1838947	FS	45°	3/16", 1/4", 5/16", 3/8", 1/2", 5/8", 3/4"	8-1/2"	4-5/8"	7-1/2"	3.5 lbs



COMPACT SWAGE TOOL KIT

The new Hilmor Compact Swage Tool is taking swaging to the next level. It has the power to swage 2-1/8" tubing and the control to swage 1/4" tubing without a crack. With its small, pistol-shape design, it can fit in the smallest of spaces. This proprietary design can reduce on-the-job fatigue with its easy setup and one-handed operation made possible by an innovative hydraulic mechanism and release button. It's even equipped for multiple sizes.



PICTURE-PERFECT SWAGING

SIMPLY SELECT THE CORRECT HEAD, PLACE IT ON THE TOOL AND MAKE A QUALITY SWAGE



LESS EFFORT, MORE CONTROL

THE POWER TO SWAGE 1-5/8" TUBING AND THE CONTROL TO SWAGE 5/16" WITHOUT SPLITTING THE TUBE



SMALL SPACE CAPABLE

A COMPACT DESIGN ALLOWS IT TO BE USED EVEN IN CRAMPED SPACES



ONE-HANDED OPERATION

THE LEVER MECHANISM AND RELEASE BUTTON ALLOW FOR ONE-HANDED SWAGING WITHOUT THE FATIGUE

Part code	Description	Tube sizes (O.D.)	Length	Width	Height	Weight
1839015	CS	3/8", 1/2", 5/8", 3/4", 7/8"	9"	1-3/4"	5"	8.5 lbs

EXPANDER HEADS & REPLACEMENT PARTS

Part code	Description	Sizes
1964042	CSEH14 Expander Head	1/4"
1839016	CSEH516 Expander Head	5/16"
1839017	CSEH38 Expander Head	3/8"
1839018	CSEH12 Expander Head	1/2"
1839019	CSEH58 Expander Head	5/8"
1839020	CSEH34 Expander Head	3/4"

Part code	Description	Sizes
1839021	CSEH78 Expander Head	7/8"
1839022	CSEH118 Expander Head	1-1/8"
1839023	CSEH138 Expander Head	1-3/8"
1839024	CSEH158 Expander Head	1-5/8"
1964043	CSEH218 Expander Head	2-1/8"
1839025	CSB Compact Swage Body Kit	N/A
1891258	Pocket Size Deburring Tool	N/A



SOFT TUBING ONLY COPPER, STEEL, ALUMINIUM, BRASS

DELUXE COMPACT SWAGE TOOL KIT
1964041

DELUXE KIT CONTENTS:
1/4", 5/16", 3/8", 1/2", 5/8", 3/4", 7/8", 1-1/8", 1-3/8", 1-5/8" EXPANDER HEADS, POCKET SIZE DEBURRING TOOL, COMPACT SWAGE TOOL

DELUXE COMPACT SWAGE TOOL KIT

Thoughtfully designed to fit into the smallest of spaces, the Hilmor Compact Swage Tool can knock out the picture-perfect swage in just one shot. An innovative hydraulic mechanism and release button let you take care of any job single-handedly.



PICTURE-PERFECT SWAGING

SIMPLY SELECT THE CORRECT HEAD, PLACE IT ON THE TOOL AND MAKE A QUALITY SWAGE



ONE-HANDED OPERATION

THE LEVER MECHANISM AND RELEASE BUTTON ALLOW FOR ONE-HANDED SWAGING WITHOUT THE FATIGUE

Part code	Description	Tube sizes (O.D.)	Length	Width	Height	Weight
1964041	DCS	1/4", 5/16", 3/8", 1/2", 5/8", 3/4", 7/8", 1-1/8", 1-3/8", 1-5/8"	9"	1-3/4"	5"	8.5 lbs

ADDITIONAL EXPANDER HEADS

Part code	Description	Sizes
1964042	CSEH14 Expander Head	1/4"
1964043	CSEH218 Expander Head	2-1/8"



SMALL DIAMETER TUBE CUTTERS

When you're in a tight space, this tool can definitely cut it. Hilmor's ruggedly durable Small Diameter Tubing Cutters offer precision cuts with minimal burrs.



RUGGED AND DURABLE

AN ERGONOMIC, CAST-ZINC BODY AND SHOCK-RESISTANT STEEL WHEEL REDUCE BURRS WHILE INCREASING LIFE AND DURABILITY



SMALL SPACE CAPABLE

A COMPACT DESIGN ALLOWS IT TO BE USED EVEN IN CRAMPED SPACES



MAXIMUM PROTECTION

A FULL-STOP THREADING SYSTEM OFFERS MAXIMUM PROTECTION FOR CUTTING WHEELS



PRECISION FLARE CUTTING

A FLARE-CUTTING GROOVE ALLOWS FOR PRECISION REMOVAL OF MATERIAL. ITEM 1885383 ONLY



SPARE BLADE STORAGE

A BONUS BLADE COMES WITH THE TOOL AND CAN BE STORED EASILY IN THE HANDLE. ITEMS 1885382 & 1885383 ONLY

Part code	Description	Diameter	Length	Width	Height	Weight
1885381	TC1858	1/8" - 5/8"	1-3/8"	3/4"	1-3/4"	4 oz
1885382	TC181	1/8" - 1"	1-3/4"	3/4"	2-3/8"	6 oz
1885383	TC18118 TC	1/8" - 1-1/8"	2"	1"	3"	8 oz



LARGE DIAMETER TUBE CUTTERS

This cutter can talk the talk without walking the walk. Hilmar's Large Diameter Tubing Cutters feature a four-roller tracking system to keep the tube from threading. All the while, a shock-resistant steel wheel cuts through the tube like a knife through butter.

 <p>RUGGED AND DURABLE AN ERGONOMIC, CAST-ZINC BODY AND SHOCK-RESISTANT STEEL WHEEL REDUCE BURRS WHILE INCREASING LIFE AND DURABILITY</p>	 <p>ACCURATE CUTTING A UNIQUE, FOUR-ROLLER TRACKING SYSTEM KEEPS THE TUBE FROM THREADING</p>
 <p>PRECISION FLARE CUTTING A FLARE-CUTTING GROOVE ALLOWS FOR PRECISION REMOVAL OF MATERIAL. ITEM 1885383 ONLY</p>	 <p>PROFESSIONAL DEBURRING CONVENIENTLY DEBURR TUBES WITH A REPLACEABLE MACHINIST'S REAMER.</p>
 <p>MAXIMUM PROTECTION A FULL-STOP THREADING SYSTEM OFFERS MAXIMUM PROTECTION FOR CUTTING WHEELS</p>	 <p>QUICK ON THE JOB QUICK-ACTION RATCHETING HELPS YOU GET THE JOB DONE IN A SNAP. ITEM 1885385 ONLY.</p>
 <p>SPARE BLADE STORAGE A BONUS BLADE COMES WITH THE TOOL AND CAN BE STORED EASILY IN THE HANDLE. ITEMS 1885382 & 1885383 ONLY</p>	

Part code	Description	Diameter	Length	Width	Height	Weight
1885384	TC18138	1/8" - 1-3/8"	2-3/4"	1-3/4"	6-1/4"	1.4 lbs
1885385	TC18134	1/8" - 1-3/4"	3"	1-3/4"	7-7/8"	1.7 lbs

ACCESSORIES

Part code	Description
1885386	Small Tubing Cutter Wheels 2PK Fits Hilmar Tubing Cutters: 1885381, 1885382
1885387	Tubing Cutter Wheels 2PK Fits Hilmar Tubing Cutters: 1885383, 1885384, 1885385
21024TCD	Replacement Deburrer for 1885384 and 1885385



A STAINLESS STEEL BLADE GIVES YOU THE STRENGTH AND PRECISION FOR ANY CUT.



PLASTIC TUBE CUTTERS

We've cut out the unnecessary complexity so you can cut plastic. Hilmor's Plastic Tubing Cutter gets the job done with ease. Simple design and intuitive features allow you to get a handle on any cut.



RUGGED AND DURABLE

AN ERGONOMIC, CAST-ALUMINUM BODY AND HIGH-CARBON STEEL BLADE INCREASE LIFE AND DURABILITY.



COMFORTABLE GRIP

A RUBBERISED HANDLE MAKES IT EASIER TO USE IN WET AND DIRTY ENVIRONMENTS



EASY TO OPEN AND CLOSE

A CONVENIENTLY POSITIONED LOCKING LATCH ALLOWS FOR TRUE ONE-HANDED OPERATION

Part code	Description	Diameter	Length	Width	Height	Weight
1885388	PTC Plastic Tube Cutter	1-5/16" MAX OD	11"	5-1/2"	1-2/5"	13 oz

REPLACEMENT BLADE

Part code	Description
1885390	PTCRB Plastic TC Rep Blade



RATCHETING PLASTIC TUBING CUTTER
1885395

RATCHETING PLASTIC TUBING CUTTER
1885393

RATCHETING PLASTIC TUBING CUTTERS

1885393



RUGGED AND DURABLE

AN ERGONOMIC, CAST-ALUMINUM BODY AND HIGH-CARBON STEEL BLADE INCREASE LIFE AND DURABILITY.



COMFORTABLE GRIP

A RUBBERISED HANDLE MAKES IT EASIER TO USE IN WET AND DIRTY ENVIRONMENTS



EASY TO OPEN AND CLOSE

A CONVENIENTLY PLACED RELEASE BUTTON ALLOWS FOR TRUE ONEHANDED OPERATION, WHILE A LOCKING TAB SECURES THE BLADE IN PLACE.

Part code	Description	Diameter	Length	Width	Height	Weight
1885393	RPTC158	1-5/8" MAX OD	9"	1-1/8"	4-1/8"	1.0 lbs

REPLACEMENT BLADE

Part code	Description
1885394	RPTC158RB Rat TC Rep Blade

1885395



RUGGED AND DURABLE

AN ERGONOMIC, CAST-ALUMINUM BODY AND HIGH-CARBON STEEL BLADE INCREASE LIFE AND DURABILITY.



EASY TO OPEN AND CLOSE

A CONVENIENTLY PLACED RELEASE BUTTON ALLOWS FOR TRUE ONEHANDED OPERATION, WHILE A LOCKING TAB SECURES THE BLADE IN PLACE.

Part code	Description	Diameter	Length	Width	Height	Weight
1885395	RPPTC238	2-3/8" MAX OD	13-1/8"	1-1/3"	6"	2.5 lbs

REPLACEMENT BLADE

Part code	Description
1885396	RPTC238RB Rat TC Rep Blade



Driven to perform. Everything about these screwdrivers says get work done. They're designed to last with a heattreated, chrome-plated shaft, yet they wouldn't dare strip out your screws.

**MORE TORQUE**

A SLIP-RESISTANT GRIP ALLOWS FOR MAXIMUM LEVERAGE.

**QUICK IDENTIFICATION**

EASY-TO-READ TIP MARKINGS ON THE HANDLE MAKE IDENTIFICATION QUICK AND EASY.

**RUGGED AND DURABLE**

DESIGNED TO LAST WITH A HEATTREATED, CHROME-PLATED SHAFT.

KEYSTONE TIP SCREWDRIVERS

Part code	Description	Shaft length	Tip type / size	Length	Width	Height	Weight
1891355	SDSLKTRS14112	1-1/2"	1/4"	3-1/2"	1-1/4"	1-1/4"	2 oz
1891352	SDSLKTSS144	4"	1/4"	8-1/8"	1"	1"	4 oz
1891356	SDSLKTRS144	4"	1/4"	8"	1-1/8"	1-1/8"	4 oz
1891358	SDSLKTRS5166	6"	5/16"	10-1/2"	1-1/4"	1-1/4"	6 oz
1891286	SDSLKTRS388	8"	3/8"	12-1/2"	1-3/8"	1-3/8"	8 oz

CABINET TIP SCREWDRIVERS

Part code	Description	Shaft length	Tip type / size	Length	Width	Height	Weight
1891287	SDSLCTRS3163	3"	3/16"	6-1/2"	1"	1"	3 oz
1891288	SDSLCTRS3166	6"	3/16"	9-1/2"	1"	1"	3 oz
1891289	SDSLCTRS146	6"	1/4"	10-1/4"	1"	1"	4 oz







TERMINAL BLOCK
SCREWDRIVER 4"
1891397

#1 PHILLIPS TIP
SCREWDRIVER 3"
1891290

**TERMINAL BLOCK
& PHILLIPS TIP
SCREWDRIVERS**

A unique screw calls for a unique screwdriver. The Terminal Block Screwdriver is one-of-a-kind with a heat-treated shaft and supercomfortable grip.

 <p>MORE TORQUE A SLIP-RESISTANT GRIP ALLOWS FOR MAXIMUM LEVERAGE.</p>	 <p>RUGGED AND DURABLE DESIGNED TO LAST WITH A HEATTREATED, CHROME-PLATED SHAFT.</p>
 <p>QUICK IDENTIFICATION EASY-TO-READ TIP MARKINGS ON THE HANDLE MAKE IDENTIFICATION QUICK AND EASY.</p>	 <p>SECURE FIT A MACHINED TIP ALLOWS FOR A BETTER FIT.</p>

TERMINAL BLOCK SCREWDRIVER

Part code	Description	Shaft length	Tip type / size	Length	Width	Height	Weight
1891397	SDTB4	4"	Terminal Block	7-1/8"	7/8"	1"	2 oz

PHILLIPS TIP SCREWDRIVERS

Part code	Description	Shaft length	Tip type / size	Length	Width	Height	Weight
1891290	SDPHRS13	3"	#1PH	6-1/2"	1"	1"	3 oz
1891391	SDPHRS2	1-1/2"	#2PH	3-1/2"	1-1/4"	1-1/4"	2 oz
1891392	SDPHRS24	4"	#2PH	8"	1"	1"	4 oz
1891393	SDPHRS27	7"	#2PH	11"	1"	1"	5 oz
1891394	SDPHRS36	6"	#2PH	10-1/2"	1-1/4"	1-1/4"	6 oz



INCLUDES STORAGE POUCH.

TIP MARKINGS FOR QUICK IDENTIFICATION.

PRECISION SCREWDRIVER SET

When the job calls for precision, reach for Hilmor. The Precision Screwdriver Set features machined tips and rotating heads. Plus, a convenient storage pouch keeps you organised.

- INCLUDES:
- 1/16" X 2" SLOTTED
 - #0 X 3" PHILLIPS
 - 3/32" X 3" SLOTTED
 - 1/8" X 4" SLOTTED
 - 1/8" X 6" SLOTTED



COMFORTABLE GRIP

OVER-MOLDED HANDLES REDUCE HAND FATIGUE AND WON'T SLIP OR TWIST.



MAXIMUM PRECISION

A ROTATING HEAD ALLOWS FOR PRECISE ADJUSTMENTS WHILE GIVING YOU GREATER CONTROL.



QUICK IDENTIFICATION

EASY-TO-READ TIP MARKINGS ON THE HANDLE MAKE IDENTIFICATION QUICK AND EASY.



STORAGE

POUCH INCLUDED FOR QUICK AND EASY STORAGE.

Part code	Description	Length	Width	Height	Weight
1891089	SDPS	10-1/4"	5"	1/8"	10 oz



5-PIECE
SCREWDRIVER SET
1891087

7-PIECE
SCREWDRIVER SET
1891088

SCREWDRIVER SETS

Tip markings on the handle for quick ID. Heat-treated shafts for extra durability. There are thousands of screwdrivers to choose from, but only one set says Hilmor. Available in 5-piece or 7-piece sets.

5-PIECE SET INCLUDES:

- #2 PHILLIPS TIP ROUND SHANK 4"
- 3/16" CABINET TIP ROUND SHANK 6"
- 1/4" CABINET TIP ROUND SHANK 6"
- 1/4" KEYSTONE TIP SQUARE SHANK 4"
- 5/16" KEYSTONE TIP ROUND SHANK 6"

7-PIECE SET INCLUDES:

- #1 PHILLIPS TIP ROUND SHANK 3"
- #2 PHILLIPS TIP ROUND SHANK 4"
- 3/16" CABINET TIP ROUND SHANK 3"
- 3/16" CABINET TIP ROUND SHANK 6"
- 1/4" CABINET TIP ROUND SHANK 6"
- 1/4" KEYSTONE TIP SQUARE SHANK 4"
- 5/16" KEYSTONE TIP ROUND SHANK 6"



MORE TORQUE

A SLIP-RESISTANT GRIP ALLOWS FOR MAXIMUM LEVERAGE.



QUICK IDENTIFICATION

EASY-TO-READ TIP MARKINGS ON THE HANDLE MAKE IDENTIFICATION QUICK AND EASY.



RUGGED AND DURABLE

RUGGED AND DURABLE DESIGNED TO LAST WITH A HEATTREATED, CHROME-PLATED SHAFT.



SECURE FIT

A MACHINED TIP ALLOWS FOR A BETTER FIT.

Part code	Description	Length	Width	Height	Weight
1891087	SD5PC	10-1/4"	1-1/4"	1-1/4"	1.4 lbs
1891088	SD7PC	10-1/2"	1-1/4"	1-1/4"	1.7 lbs



9 IN 1 MULTI-TOOL

When you've got a lot of jobs but not a lot of time, the 9 in 1 Multi-Tool from Hilmor can save the day. It features a slip-resistant grip for more torque and a thick-walled shaft for more durability.

BIT SIZES
 #1 & #2 PHILLIPS, 3/16" & 1/4" SLOTTED, #2 SQUARE, 1/4", 5/16", AND 3/8" NUT DRIVERS, AND VALVE CORE REMOVER.



RUGGED AND DURABLE

DESIGNED WITH THICK SHAFT WALLS FOR LONG LIFE AND LESS STRIPPING.



MORE TORQUE

A SLIP-RESISTANT GRIP ALLOWS FOR MAXIMUM LEVERAGE.

Part code	Description	Length	Width	Height	Weight
1839053	9IN1SV	7-1/4"	1-1/3"	1-1/3"	7 oz
1937819	MT9IN16	10-1/2"	1-1/8"	1-1/8"	10 oz

6 IN 1 STUBBY MULTI-TOOL

Small spaces come standard in HVAC/R. That's why you need the Hilmor 6 in 1 Stubby Multi-Tool. Its compact design fits right in, giving you the necessary torque to tighten or loosen a screw or nut.

BIT SIZES
 3/16" AND 1/4" SLOTTED, #1 AND #2 PHILLIPS, 1/4" AND 5/16" NUT DRIVERS.



SMALL SPACE CAPABLE

A COMPACT DESIGN ALLOWS FOR USE IN TIGHT SPACES.



MORE TORQUE

A SLIP-RESISTANT GRIP ALLOWS FOR MAXIMUM LEVERAGE.



SIMPLE SETUP

EASILY CHANGE BETWEEN SIX DIFFERENT DRIVERS - 3/16" AND 1/4" SLOTTED, #1 AND #2 PHILLIPS, 1/4" AND 5/16" NUT DRIVERS.

Part code	Description	Length	Width	Height	Weight
1891351	MTS	4-7/8"	1-1/4"	1-1/4"	3 oz.



RATCHETING 9 IN 1 MULTI-TOOL

A simple twist of the hand can drive a screw, nut or bolt in no time. Nine different bits are at your disposal. A ratcheting mechanism and an ergonomic rubber grip comes standard.

BIT SIZES

#1 & #2 PHILLIPS, 3/16" & 1/4" SLOTTED, #2 SQUARE, 1/4", 5/16", AND 3/8" NUT DRIVERS, AND VALVE CORE REMOVER.



RUGGED AND DURABLE

DESIGNED WITH A HIGH-TORQUE RATCHETING MECHANISM AND THICK SHAFT WALLS FOR LONG LIFE AND LESS STRIPPING.



MORE TORQUE

A SLIP-RESISTANT GRIP ALLOWS FOR MAXIMUM LEVERAGE.



SIMPLE SETUP

EASILY CHANGE BETWEEN FORWARD, REVERSE AND LOCKED POSITIONS.

FEATURES 9 DRIVING BITS, INCLUDING A VALVE CORE REMOVER.

Part code	Description	Length	Width	Height	Weight
1891259	MTR91	8-1/2"	1-1/4"	1-1/4"	12 oz

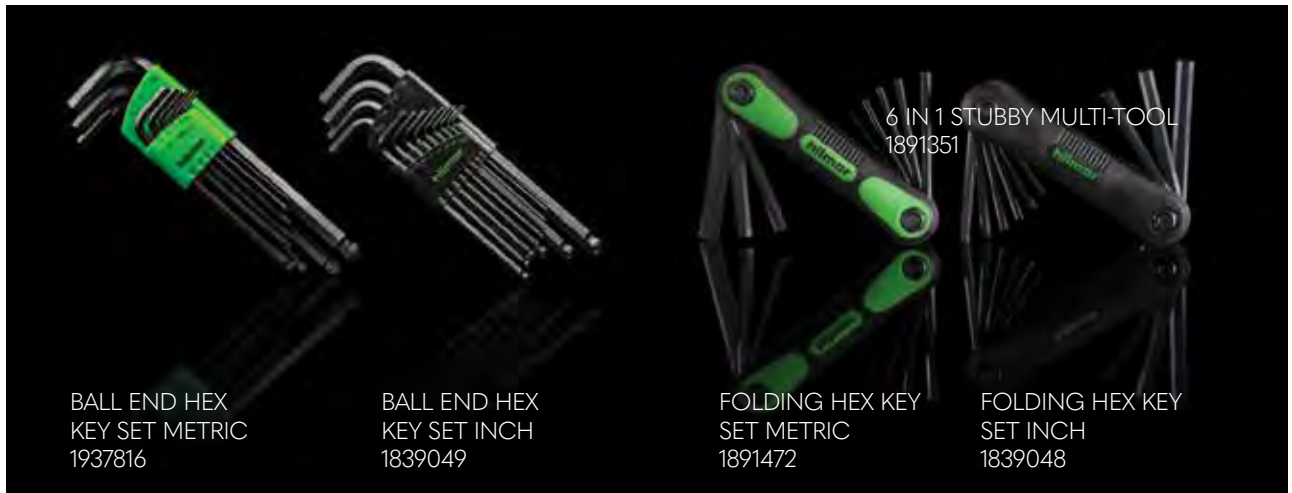

BALL END HEX KEY SET METRIC
1937816

BALL END HEX KEY SET INCH
1839049

FOLDING HEX KEY SET METRIC
1891472

FOLDING HEX KEY SET INCH
1839048

6 IN 1 STUBBY MULTI-TOOL
1891351

HKSS / HKSBEH HEX KEY SETS

Hex head screws have nowhere to hide. Hilmor Hex Key Sets have standard and metric sizes covered. They're slipresistant so you never lose your grip and always keep your cool.

HKSS sizes

.05", 1/16", 5/64", 3/32", 7/64", 1/8", 9/64", 5/32", 3/16", 7/32", 1/4", 5/16", 3/8"

HKSBEH sizes

1.5mm, 2mm, 2.5 mm, 3mm, 4mm, 5mm, 6mm, 8mm, 10mm

Part code	Description	Length	Width	Height	Weight
1839049	HKSS Ball End Hex Key Set inch	7-1/4"	2-3/4"	3/4"	13 oz
1937816	HKSBEH Ball End Hex Key Set metric	7"	2-1/2"	3/4"	12 oz

FOLDING HEX KEY SETS

You don't fold on the job. Luckily, this set does for easy, convenient storage. Available in inch and metric.

HKSS sizes

5/64", 3/32", 7/64", 1/8", 9/64", 5/32", 3/16", 7/32", 1/4"

HKSBEH sizes

1.5mm, 2mm, 2.5mm, 3mm, 4mm, 5mm, 6mm, 8mm

Part code	Description	Length	Width	Height	Weight
1839048	HKFS Folding Hex Key Set inch	4-1/4"	7/8"	1-5/8"	5 oz
1891472	HKFSM Folding Hex Key Set metric	4-1/4"	7/8"	1-5/8"	5 oz



DIGITAL ADJUSTABLE TORQUE WRENCH

Tightening to true torque when working on mini-splits is serious business. Under tightening could result in refrigerant leaks, while overtightening could mean burst tubing. That's why the Hilmor Digital Adjustable Torque Wrench is critical to perfecting torque time and time again. The 9 factory memory settings make it quick to set common torque values, while the digital display shows the amount of force applied to the flare nut. And if that didn't make the job easy enough, lights and buzzers illuminate and sound when the desired torque is achieved.



LIGHTEN YOUR LOAD

ADJUSTABLE JAW ELIMINATES THE NEED TO CARRY AROUND EXTRA HEADS.



EASY TO USE

NINE PROGRAMMABLE MEMORY SETTINGS ALLOW FOR QUICK ACCESS TO THE MOST COMMON TORQUE LEVELS.



PRECISE READINGS

DIGITAL ADJUSTMENTS HELP ENSURE TORQUE MEASUREMENT ACCURACY.



EXTRA CONFIDENCE

LED LIGHTS AND BUZZER INDICATE THAT DESIRED TORQUE HAS BEEN REACHED.

Part code	Description	Jaw capacity	Accuracy	Batteries	Length	Width	Weight
1963826	DAJTW	1/4" to 1-1/16" to accommodate up to 5/8" flare nuts	+ / 3%	AA (x2)	17"	2-3/8"	2 lbs



ADJUSTABLE WRENCHES

Take your pick of imperial or metric scales. They come standard on all of our Adjustable Wrenches. They're made to fit in your hand with ergonomic grips and made to last by Hilmor.



COMFORTABLE GRIP

OVER-MOULDED HANDLES REDUCE HAND FATIGUE AND WON'T SLIP OR TWIST.



ADDED VERSATILITY

GET TWO-IN-ONE CAPABILITIES WITH BOTH INCH AND METRIC SCALES.

Part code	Description	Sizes	Jaw capacity (up to)	Length	Width	Height	Weight
1885369	AW6	6"	1"	6-3/8"	1-3/4"	1/2"	6 oz
1885370	AW8	8"	1-1/8"	8-1/4"	1"	5/8"	12 oz
1885421	AW10	10"	1-1/4"	10"	2-5/8"	3/4"	1.1 lbs
1885422	AW12	12"	1-1/2"	12-1/8"	2-7/8"	3/4"	1.7 lbs



QUICK-ADJUSTING TONGUE & GROOVE PLIERS

We've made an adjustment to standard pliers. Our Quick-Adjusting Tongue and Groove Pliers feature a simple push button to give you a quick precision grip on pipes, fasteners and more.

- 

SIMPLE SIZING
A PUSH BUTTON ALLOWS FOR QUICK ADJUSTMENTS WHILE MULTIPLE GROOVES GUARANTEE PRECISE POSITIONING.
- 

COMFORTABLE GRIP
OVER-MOULDED HANDLE REDUCES HAND FATIGUE AND WON'T SLIP OR TWIST.
- 

STRONG HOLD
MACHINED JAWS INCREASE GRIP ON THE MATERIAL EVERY TIME.

Part code	Description	Sizes	Jaw capacity (up to)	Length	Width	Height	Weight
1890996	PBTGP8	8"	1-1/2"	8-1/4"	5/8"	1-3/4"	9 oz
1890998	PBTGP12	12"	2-3/16"	12-1/4"	3/4"	2-1/2"	1.4 lbs

PLIERS

LINEMAN'S PLIERS



STAYS SHARP

A LASER-HARDENED CUTTING EDGE WILL STAY SHARPER FOR LONGER.



STRONG HOLD

CROSS-CUT KNURLED JAWS INCREASE GRIP ON THE MATERIAL EVERY TIME.



COMFORTABLE GRIP

OVER-MOLDED HANDLES REDUCE HAND FATIGUE AND WON'T SLIP OR TWIST.

Grab. Twist. Cut. Repeat. Over and over again. A laser-hardened cutting edge stays sharp longer, and crosscut knurled jaws guarantee a strong grip time after time. Hilmor Lineman's Pliers will last.

Part code	Description	Sizes	Length	Width	Height	Weight
1885399	LP85	8-1/2"	8-3/4"	2"	7/8"	13 oz.
1885411	LP95	9-1/2"	9-1/2"	2-1/4"	7/8"	1.0 lbs.

LONG NOSE PLIERS



STAYS SHARP

A LASER-HARDENED CUTTING EDGE WILL STAY SHARPER FOR LONGER.



STRONG HOLD

CROSS-CUT KNURLED JAWS INCREASE GRIP ON THE MATERIAL EVERY TIME.



COMFORTABLE GRIP

OVER-MOLDED HANDLES REDUCE HAND FATIGUE AND WON'T SLIP OR TWIST.

It's tough to beat a good pair of pliers. A laser-hardened cutting edge, crosscut knurled jaws and over-molded handles make Hilmor Long Nose Pliers pretty darn tough to beat.

Part code	Description	Sizes	Length	Width	Height	Weight
1885397	LNP6	6"	6-7/8"	2-1/8"	5/8"	4 oz
1885398	LNP8	8"	8-5/8"	2-1/8"	3/4"	8 oz

DIAGONAL CUTTING PLIERS



STAYS SHARP

A LASER-HARDENED CUTTING EDGE WILL STAY SHARPER FOR LONGER.



COMFORTABLE GRIP

OVER-MOLDED HANDLES REDUCE HAND FATIGUE AND WON'T SLIP OR TWIST.

What's our angle? To make a great pair of pliers. The Diagonal Cutting Pliers stay sharp as a samurai sword with a laser-hardened cutting edge.

Part code	Description	Sizes	Length	Width	Height	Weight
1885412	DCP6	6"	6-3/4"	2-1/8"	3/4"	4 oz
1885363	DCP8	8"	8"	2-1/8"	3/4"	12 oz

CRIMPING TOOL



STAYS SHARP

A LASER-HARDENED CUTTING EDGE WILL STAY SHARPER FOR LONGER.



COMFORTABLE GRIP

OVER-MOLDED HANDLES REDUCE HAND FATIGUE AND WON'T SLIP OR TWIST.

CAPACITY	
WIRE	10-22AWG
INSULATED TERMINALS	10-22AWG
NON-INSULATED TERMINALS	10-22AWG

Crimp. Cut. We've got you covered. The Hilmor Crimping Tool handles both insulated and non-insulated terminals. Over-molded handles and a hardened cutting edge come standard, too.

Part code	Description	Sizes	Length	Width	Height	Weight
1885429	FC10	10"	9-7/8"	2-1/4"	3/4"	1.1 lbs.

REFRIGERANT RECOVERY PLIERS



Smart features that save refrigerant and time. Our Refrigerant Recovery Pliers make evacuating equipment quick and easy. The pliers have a valve on one end with a sharp needle point and a gasket to keep all recovered refrigerant in the system and prevent leaks.

Part code	Description	Sizes	Weight
1937677	RRP	1/4" to 1-1/8"	13 oz

**RUGGED AND DURABLE**

PLIERS ARE BUILT TO LAST, MANUFACTURED FROM HIGH-GRADE HEAT-TREATED ALLOY STEEL FOR DURABILITY.

**SECURELY LOCKS IN PLACE**

A CLASSIC TRIGGER RELEASE IS DESIGNED TO PROVIDE A TIGHT CONNECTION DURING RECOVERY, REDUCING THE POTENTIAL FOR A LEAK.

**ADDED VERSATILITY**

DESIGNED TO QUICKLY LOCK ON TO AND PIERCE REFRIGERANT LINE FROM 1/4" TO 1-1/8" IN DIAMETER, LEAVING BOTH HANDS FREE TO DO OTHER WORK.

**PRECISION ADJUSTMENTS**

ADJUSTING SCREW IN THE HANDLE ALLOWS FOR QUICK AND PRECISE PRESSURE CHANGES BETWEEN DIFFERENT TUBING DIAMETERS.

WIRE STRIPPERS



COMFORTABLE GRIP

OVER-MOLDED HANDLES REDUCE HAND FATIGUE AND WON'T SLIP OR TWIST.



QUICK ID

EASY-TO-READ SIZE MARKINGS ON THE JAWS MAKE IDENTIFICATION SIMPLE.



BOLT CUTTING

CUTS 4-40, 5-40, 6-32, 8-32, 10-24, 10-32 BOLTS AND SCREWS TO DESIRED SIZE. *1885424 ONLY.

The Hilmor Wire Strippers feature easy-to-read size markings, which means you can strip wires with ease and without damage. Electrical work is no laughing matter, and these Wire Strippers are no joke.

Part code	Description	Sizes	Capacity	Length	Width	Height	Weight
1885426	WS7	7"	10-20AWG	7-1/4"	2-1/8"	5/8"	6 oz
1885427	WS6	6"	10-20AWG	6-1/2"	2-1/4"	5/8"	5 oz.
1885424	WS8	8"	10-22AWG	8"	2-5/8"	5/8"	8 oz.

DEBURRING

DEBURRING TOOLS



Whether they're inside or outside, copper or plastic, Hilmor Deburring Tools can smooth things over. With steel blades, the standard Deburrer works flawlessly on OD tubing from 1/4" to 1-5/8". And our Pocket Size Deburring Tool lets you put your silkysmooth signature on even the smallest pieces of tubing.

Part code	Description	Sizes	Length	Width	Height	Weight
1839052	DBUR	1/4" to 1-5/8"	2-3/8"	2-1/8"	2-1/8"	2 oz
1891258	DBURPS	1/4" and up	5-1/2"	3/8"	3/8"	7 oz

FIN TOOLS

FIN STRAIGHTENING TOOLS



A condenser should work as efficiently as you. These tools make it easy to remove debris and straighten fins.

Part code	Description	Sizes	Length	Width	Height
T-100	Fin tool kit	8, 9, 10, 11, 12, 14 FPI	5-3/4"	2"	1-1/2"



FOLDING UTILITY KNIFE

Hilmer's Folding Utility Knife stands up to the test with an all-metal body. It's your new knife.



YOU WON'T FOLD ON THE JOB. WITH A LINER LOCK, THIS KNIFE WON'T EITHER. UNTIL YOU WANT IT TO.



RUGGED AND DURABLE

AN ALL-METAL BODY INCREASES LIFE AND DURABILITY.



SECURELY LOCKS BLADE

A BLADE-LOCKING MECHANISM PREVENTS THE BLADE FROM COMING OUT DURING USE.



ONE-HANDED OPERATION

A LINER-LOCK FOR ONE-HANDED OPERATION AND EXTRA SAFETY.



SUPERIOR VERSATILITY

A BUILT-IN WIRE-STRIPPING CHANNEL FOR UP TO 10-GAUGE WIRE IS THERE WHEN YOU NEED IT.



BELT CLIP

A BELT CLIP KEEPS KNIFE CLOSE FOR EASY ACCESS.

Part code	Description	Length	Width	Height	Weight
1885433	UKHF	1-1/2"	3/4"	4"	5 oz.

UTILITY KNIFE BLADES

Part code	Description
1885432	UKB Utility Knife Blades 5PK



THREE ZIPPERED POUCHES AND TWO PADDED SIDE POCKETS PROVIDE SAFE STORAGE FOR YOUR METER.

TOOL CENTRE BAG

The Hilmor Tool Center Bag is your total tool storage solution. It includes 24 exterior and interior pockets and three zippered pouches so you can store your tools safely and find them quickly.

EXTRA FEATURES
CLEAR VINYL ID WINDOW POCKET;
SHOULDER STRAP; COVER FLAP



KEEP ORGANISED

24 POCKETS AND THREE ZIPPERED POUCHES.



SECURE STORAGE

STOW YOUR METER AWAY SAFELY IN EITHER OF THE TWO PADDED POCKETS ON THE EXTERIOR SIDES OF THE TOTE.



HELPS WITH THE HEAVY LIFTING

THIS BAG HAS ROOM FOR MULTIPLE TOOLS AND IS TESTED UP TO 50 LBS. THE PADDED SHOULDER STRAP MAKES CARRYING MORE COMFORTABLE.



RUGGED AND DURABLE

DESIGNED TO LAST WITH A HARD PLASTIC, WATER-RESISTANT BOTTOM AND A PADDED ALUMINIUM CARRYING HANDLE.

Part code	Description	Pockets interior	Pockets exterior	Length	Width	Height	Weight
1839079	TCB	13; 18 Tool Loops	11	13-1/2"	8-1/2"	9"	4.5 lbs



A METAL LOOP GIVES YOU AN EASY WAY TO TRANSPORT YOUR MANIFOLD.

TWO PADDED, ZIPPERED SIDE POCKETS PROVIDE SAFE STORAGE FOR YOUR METER.

BACKPACK TOOL BAG

The Hilmor Backpack Tool Bag is your jobsite sidekick with 19 exterior and interior pockets. Its sturdy rubber, water-resistant bottom means rain or shine, the contents inside won't be damaged. And while it's spacious enough to hold up to 50 lbs., padded shoulder straps and a back air vent make hauling it a little more comfortable and leave your hands free to safely climb a ladder.

19 EXTERIOR AND INTERIOR POCKETS ALLOW YOU TO STORE TOOLS SAFELY AND FIND THEM QUICKLY.



SECURE STORAGE

STOW YOUR METER AWAY SAFELY IN EITHER OF THE TWO PADDED ZIPPER POCKETS ON THE EXTERIOR SIDES OF THE TOTE.



SUPERIOR VERSATILITY

HANG YOUR MANIFOLD FROM THE BAG'S METAL LOOP FOR EASY TRANSPORT TO THE JOBSITE.



HELPS WITH THE HEAVY LIFTING

THIS BAG HAS ROOM FOR MULTIPLE TOOLS AND IS TESTED UP TO 50 LBS. THE PADDED SHOULDER STRAPS AND AIR VENT BACK MAKE CARRYING MORE COMFORTABLE.

Part code	Description	Pockets interior	Pockets exterior	Length	Width	Height	Weight
1839080	BKB	11	8	6"	14"	16"	4.5 lbs

WARRANTY - REPAIR

BOSCH WARRANTY & REPAIR

BOSCH PROMAX[®] ROBINAIR

OUR SERVICE CENTRE WILL UNDERTAKE...

- Repairs to **PROMAX** and **BOSCH** recovery machines
- Repairs and servicing to **ROBINAIR** vacuum pumps
- **TIF** scale calibration and certificate (£60 charge)

STANDARD RETURN PROCEDURE...

- Send PO to our sales email (sales@diversitech.com)
- Fill out the form (page 2) and send it back with the machine
- Send the machine back to our address in Nottingham, quoting PO number
- The machine will be inspected, and a repair quote sent to the wholesaler, along with invoice for £40
- On receipt of the order for the repair quote, the machine will be repaired and returned

WARRANTY RETURN PROCEDURE...

Our standard warranty is one year from date of purchase unless stated differently (Some leak detectors are 2 years)

- Send the machine back to our address in Nottingham with a copy of proof of purchase and date
- Fill out the attached form and send it back with the machine
- The machine will be inspected
- It will be repaired or replaced at the discretion of DiversiTech International
- The machine will be returned to the customer with no repair costs

IMPORTANT: All units will be kept for a maximum of 60 days from customer quotation date. After this date, if no response has been received, the unit will be discarded.

Note: If you are making a warranty claim, proof of purchase is required.

A charge of £40 will be made prior to the inspection of any unit (excluding warranty returns).

Vacuum pumps must be drained of oil prior to shipping. Heavily contaminated units (oil) will incur a additional cleaning charge.

Recovery machines need to have both valves fully open and relieved of pressure prior to shipping. This should be done by a competent engineer.

Please note: Warranty claims are returned to DiversiTech International at the customer's expense. DiversiTech International will assess your claim, and provide feedback after the unit has been inspected and tested. Repair requests will be assessed, and an individual quote will be provided. A repair request will incur a charge.

ITEM	PAGE	ITEM	PAGE	ITEM	PAGE
SAE REUSABLE HOSE	66	BASKET TRAY COUPLERS - PAIR	124	CONDENSATE COP™ DRAIN PAN SWITCH	25
1 LITRE TANK PUMP	19, 20, 21	BASKET TRAY HOLD DOWN CLAMP	124	CONDENSATE DRAIN ADAPTOR	23, 87
1.4 LITRE TANK PUMP	19	BASKET TRAY JOINTING KIT - 4 PART KIT	124	CONDENSER MOUNTING BRACKET	30
1.9 LITRE TANK PUMP	19	BASKET TRAY QUIK CONNECT - 100 X 60 X 3MM	124	CONDENSING GUARD	26, 103
1/4" TO 5/16" BRASS ADAPTOR	206	BASKET TRAY SUSPENSION HANGER	124	CONNECTION PIECE	37
FIN TOOLS AND COMBS	60	BASKET TRAY WALL SUPPORT BRACKET - 150MM	124	COOL-WELD HEAT BARRIER SPRAY	68, 91
140MM 90 DEGREE INTERNAL BEND	104	BATTERY CHARGER 240V	161	CORE REMOVAL TOOL	74
140MM 90 DEGREE INTERNAL/EXTERNAL BEND	104	BEAM G CLAMP	120	CORE REMOVAL TOOL & STORER ACCESS FITTING	49, 74
140MM STRAIGHT CONNECTOR	104	BIGTIE	36, 133	CORE REMOVAL TOOL ACCESS FITTING	49
140MM TRUNKING (2000MM LENGTH)	104	CONDENSATE BRAIDED HOSE	24	CORK INSULATION TAPE	75
140MM WALL COVER	104	BOILER & HEATING	81	CUSHIO CLAMP	43
16 AND 17 FPI - LIME	60	BOILER BUOY - CONDENSATE BYPASS VALVE	86	DAIRY CABINET PUMP	6
18 AND 20 PI - RED	60	BOSCH CS LD 1.0	156	DEBURRING TOOL	180
190 DEGREE RETURN BEND COPPER FITTING	52	BOSCH IR LD	157	DIGITAL LCD DISPLAY VACUUM GAUGE	175
2 LITRE TANK PUMP	20	BOSCH RECOVERY UNIT	145	DIVERSI-FLUSH HVAC FLUSHING KIT	58
2 LITRE TANK PUMP	19	BUBBLE UP LEAK DETECTOR PRE-MIXED	56	DIVERSI-FLUSH SOLVENT REFILL	58
3 IN 1 MULTIPURPOSE OIL	68	CABLE 2 CORE	133	DIVERSI-GUM SEALING COMPOUND	69, 92
3 POLE ROTARY ENCLOSED ISOLATOR	10, 98, 132	CABLE 3 CORE	133	DOUBLE MOUNTING PLATE	113, 114, 115
3-WAY SOLDER FITTING ACCESS FITTING	49	CABLE 4 CORE	133	DRAIN DAWG™ KIT	25
3.8 LITRE TANK PUMP	19	CABLE 5 CORE	133	DRAIN GUN	58, 89
4 POLE ROTARY ENCLOSED ISOLATOR	10, 98, 132	CABLE 7 CORE	133	DRAIN HOSE	35
45 DEGREE ELBOW CXC COPPER FITTING	51	CABLE STUFFING GLAND	132	DRAIN KAT™	25
45 DEGREE STREET ELBOW FXC COPPER FITTING	51	CABLE TIE	133	DROP IN ANCHOR	129
5/16 MAGNETIC SOCKET ADAPTOR	127	CABLE TIE BASE	133	DROP IN ANCHOR LIPPED	129
6" LOW LOSS BALL VALVE ADAPTOR HOSE 1/4" X 1/4"	206	CABLE TIE CLIPS	47	DROP IN ANCHOR SETTING TOOL	129
8 AND 10 FPI - ORANGE	60	CABLE TIE MOUNT	133	DRY R MOISTURE ELIMINATOR	70
9 AND 15 FPI - YELLOW	60	CABLE TRAYS	122	DUCT	37
90 DEGREE ELBOW CXC COPPER FITTING	50	CABLE TRAY COUPLER	123	DUCT CAP	37
90 DEGREE EXTERNAL BEND	104	CABLE TRAY FLAT BEND	122	EASYBEND LINE SET BENDER	202
90 DEGREE FLAT BEND	104	CABLE TRAY HANGER	123	ECONOMY BRACKET WITH CROSSBAR	28, 112
90 DEGREE LONG TURN ELBOW CXC COPPER FITTING	50	CABLE TRAY INTERSECTION	123	END CAP COPPER FITTING	51
90 DEGREE LONG TURN STREET ELBOW FXF COPPER FITTING	50	CABLE TRAY REDUCER	123	ENVIRONMENTALLY FRIENDLY PRE - MIXED COIL CLEANER	56
90 DEGREE STREET ELBOW FXF COPPER FITTING	50	CABLE TRAY STAND OFF BRACKET	123	EQUAL TEE CXCXC COPPER FITTING	53
90 DEGREE BRACKET - 2 HOLE/ 2 HOLE	120	CABLE TRAY TEE	122	EVAPORATOR & CONDENSING COIL CLEANER	56
90 DEGREE BRACKET - L. HOLE/ 2 HOLE	120	CANTILEVER ARMS	30	EVAPORATOR COIL CLEANER WITH DISINFECTANT	56
90 DEGREE BRACKET - L. HOLE/ L. HOLE	120	CAP BRASS FITTING	48	EXPANDER HEAD 1-1/8"	180
90° ELBOW COUPLER (45° FLARE)	206	CASE CLEAN - CASE, FASCIA & GLASS CLEANER	57	EXPANDER HEAD 1-3/8"	180
ABRASIVE CLOTH - 120 GRIT - 1-1/2" X 10 YARDS	75, 90	CASSETTE ADAPTOR	23	EXPANDER HEAD 1-5/8"	180
AC	19	CHANNEL 4 WAY INTERSECTION	120	EXPANDER HEAD 1/2"	180
AC SHUT OFF SWITCH	25	CHANNEL 4-HOLE EXTERNAL CONNECTOR	121	EXPANDER HEAD 1/4"	180
ACCESS FITTING - FEMALE FLARE ACCESS FITTING	49	CHANNEL 4-HOLE INTERNAL CONNECTOR	121	EXPANDER HEAD 3/4"	180
ACID ELIMINATOR - 115ML	70	CHANNEL BASE PLATE	120	EXPANDER HEAD 3/8"	180
ACID TEST KIT - AB AND MINERAL OIL	70	CHANNEL BLACK CAPPING	120	EXPANDER HEAD 5/8"	180
ACID TEST KIT - AB AND MINERAL OIL	70	CHANNEL CLAMP	120	EXPANDER HEAD 7/8"	180
ACID TEST KIT - WITH POE OIL	70	CHANNEL INTERNAL ANGLE - 45 DEGREE 135	120	EXTENDED COPPER TUBE FITTING ACCESS FITTING	49
ADAPTOR - SAE FEMALE TO MNPT ACCESS FITTING	49	CHANNEL INTERNAL ANGLE - 45 DEGREE	120	EYE BOLT - MB X 80MM	128
ADJUST FLAT BEND 45-90 DEGREE	37	CHANNEL OFFSET - 45 DEGREE	120	EYE BOLT - ML OX 80MM	128
AIR SOURCE HEAT PUMP SOAKAWAY	100	CHANNEL U BRACKET	121	FAN BLADE	9
ALUMINIUM FOIL TAPE	75	CHANNEL WING FITTING	120	FAN GUARD	9
ANCHOR BOLTS	128	CHANNEL Z BRACKET	121	FAN RING	9
ANTI SYPHON KIT - 9.5MM (3/8")	87	CLEAR VINYL HOSE	24	FEMALE ADAPTOR C X FEMALE NPT COPPER FITTING	53
ANTI-VIBRATION MOUNTING BOLTS	30, 99	CLEAR CONDENSATE BRAIDED HOSE	24	FILL & FLUSH FLOW SETTER 1" FEMALE/FEMALE	99
ANTI-VIBRATION MOUNTING STRIP	39	CLEAR SILICONE SEALANT	69	FILTER & TIP FOR ZX-1A	159
ASHP	95	CLIPLIGHT A/C DYE	67	FIN BRUSH	60
AUDIBLE ALARM FOR ALL PUMPS WITH A HIGH-LEVEL ALARM SWITCH	23	CLIPLIGHT DYE CLEANER	67	FIN TOOL	60
AUDIBLE ALARM FOR ALL PUMPS WITH A HIGH-LEVEL SWITCH	87	CLIPLIGHT ESTER & DYE	67	FIN TOOL WITH HEAVY DUTY BICYCLE HANDLE	60
AUTOMATIC HALOGEN REFRIGERANT LEAK DETECTOR	158	CLIPLIGHT HYBRID A/C COMPRESSOR OIL	67	FIXINGS	119
AXIAL FAN MOTOR - 13W (WITH LEAD)	8	CLIPLIGHT MULTI-PURPOSE DYE	67	FLARE & MPT ELBOW BRASS FITTING	48
AXIAL FAN MOTOR - 15W (WITH LEAD)	8	CLIPLIGHT PAG & DYE (100 VISCOSITY)	67	FLARE AND MPT ELBOW BRASS FITTING	48
AXIAL FAN MOTOR - 20W (WITH LEAD)	8	CLIPLIGHT PAG & DYE (46 VISCOSITY)	67	FLARE TEE BRASS FITTING	48
AXIAL FAN MOTOR - 20W (WITH TERMINAL)	8	CLIPLIGHT PAO 68 OIL	67	FLARE UNION BRASS FITTING	48
BACK BOX 2 GANG - 25MM	89, 132	CLIPLIGHT PAO 68 OIL & DYE	67	FLARE UNION X MPT BRASS FITTING	49
BACK BOX 2 GANG - 35MM	89, 132	CLIPLIGHT RADIATOR DYE	67	FLARE X FLARE SWIVEL UNION BRASS FITTING	49
BACK BOX SURFACE MOUNT - 25MM	89, 132	CLIPSTRIP - AQUA POCKET LIGHT	61	FLARE X FPT UNION BRASS FITTING	49
BACK BOX SURFACE MOUNT - 35MM	89, 132	CLIPSTRIP - POCKET LIGHT	61	FLASH - UP TO 5 TONS (17KW)	65
BACK PLATE - MB/ ML O	120	COACH SCREW	127	FLASH KIT	65
BACK PLATE FOR MOUNTING M8/M10	44, 130	COIL CARE - EVAPORATOR CLEANER & DISINFECTANT	57	FLAT / FORM A WASHER	125
BASKET CLAMPING PIECE - PACK OF 50	124	COIL CLEAN - UNIVERSAL COIL CLEANER	57	FLAT BEND 45 DEGREE	37
BASKET CORNER CONNECTOR	124	COIL FOAM - HEAVY DUTY CONDENSER CLEANER	57	FLAT BEND 90 DEGREE	37
BASKET TRAYS	124	COMBUSTIBLE GAS LEAK DETECTOR	161	FLAT PLATE	121
BASKET TRAY CEILING BRACKET	124	COMPRESSION SPRAYER	57	FLAT ROSETTE	37
BASKET TRAY CENTRAL SUPPORT HANGERS - PAIR	124	LIME SCALE REMOVER	56	FLEXI BASE FRAME	108

INDEX BY ITEM



ITEM	PAGE	ITEM	PAGE	ITEM	PAGE
FLEXI CROSS BAR	115	HILMOR AW6 WRENCH	238	HILMOR SDSLKTRRS5166 SCREWDRIVER	230
FLEXI END BAR	115	HILMOR AW8 WRENCH	238	HILMOR SDSLKTS144 SCREWDRIVER	230
FLEXI EXTENDER FRAME	108	HILMOR CBK TUBE BENDER KITS	217	HILMOR SDBT4 SCREWDRIVER	231
FLEXI FIX PACK TO SECURE A OUTDOOR UNIT	111	HILMOR CBKRB TUBE BENDER KITS	217	HILMOR SMALL TUBING CUTTER WHEELS 2PK	227
FLEXI FOOT - 200MM FOR VERTICAL STRUT	112	HILMOR CBRBM REV BEND ATT TUBE BENDER	217	HILMOR TB31612 TUBE BENDERS	220
FLEXI FOOT - 350MM FOR VERTICAL 2.5 DEGREE	112	HILMOR CM35 FRAME 15MM, 22MM AND 28MM FORMER AND GUIDES	220	HILMOR TB31638 TUBE BENDERS	218
FLEXI FOOT - 350MM FOR VERTICAL 5.0 DEGREE	112	HILMOR CM35 FRAME FORMER AND GUIDES	220	HILMOR TC181 TUBE CUTTER	226
FLEXI FOOT - 350MM FOR VERTICAL STRUT	112	HILMOR CM35 FRAME ONLY TUBE BENDERS	220	HILMOR TC18118 TC TUBE CUTTER	226
FLEXI FOOT - 500MM FOR VERTICAL 2.5 DEGREE	112	HILMOR CS SWAGING	224	HILMOR TC18134 TUBE CUTTER	227
FLEXI FOOT - 500MM FOR VERTICAL 5.0 DEGREE	112	HILMOR CSB COMPACT SWAGE BODY KIT SWAGING	224	HILMOR TC18138 TUBE CUTTER	227
FLEXI FOOT - 500MM FOR VERTICAL STRUT	112	HILMOR CSEH118 EXPANDER HEAD SWAGING	224	HILMOR TC1858 TUBE CUTTER	226
FLEXI FOOT FIX CLAMP	99, 111	HILMOR CSEH112 EXPANDER HEAD SWAGING	224	HILMOR TOOLS	215
FLEXI FOOT MINI	112	HILMOR CSEH138 EXPANDER HEAD SWAGING	224	HILMOR TUBING CUTTER WHEELS 2PK	227
FLEXI FOOT SINGLE	98, 110	HILMOR CSEH14 EXPANDER HEAD SWAGING	225	HILMOR UKB UTILITY KNIFE BLADES 5PK	243
FLEXI FOOT UNIVERSAL - 250MM	111	HILMOR CSEH158 EXPANDER HEAD SWAGING	224	HILMOR UKHF UTILITY KNIFE	243
FLEXI FOOT WITH STRUT	110	HILMOR CSEH218 EXPANDER HEAD SWAGING	225	HILMOR WS6 WIRE STRIPPERS	242
FLEXI H-FRAME KIT	109	HILMOR CSEH34 EXPANDER HEAD SWAGING	224	HILMOR WS8 WIRE STRIPPERS	242
FLEXI HAND RAIL FOR HOP OVER	117	HILMOR CSEH38 EXPANDER HEAD SWAGING	224	HOSE CLAMP	24, 87
FLEXI HOP OVER	117	HILMOR CSEH516 EXPANDER HEAD SWAGING	224	HOSE CLIP	87
FLEXI INJECT SEALANT ADVANCED	66	HILMOR CSEH58 EXPANDER HEAD SWAGING	224	HOSE CONNECTOR	24, 87
FLEXI LITE KIT	38, 97	HILMOR CSEH78 EXPANDER HEAD SWAGING	224	HOSE GASKETS	206
FLEXI LITE SLAB KIT - 3 FEET	38, 97	HILMOR DAJTW WRENCH	237	HTOOLS	179
FLEXI PATCH FIBREGLASS REPAIR PATCH	76, 92	HILMOR DBUR DEBURRING TOOL	242	ICE MACHINE CLEANER	56
FLEXI QUAD (ADJUSTABLE LEGS)	114	HILMOR DBURPS DEBURRING TOOL	242	IMPERIAL ACCESS VALVES & ADAPTORS	199
FLEXI STEP OVER	117	HILMOR DCP6 PLIERS	241	IMPERIAL ADAPTORS	197
FLEXI SUPPORT SYSTEMS	107	HILMOR DCP8 HILMOR PLIERS	241	IMPERIAL COMBINATION TOOLS	196
FLEXI TWIN (ADJUSTABLE LEGS)	113	HILMOR DCS SWAGING	225	IMPERIAL FLARING & SWAGING	189
FLEXI-FOOT KIT	98	HILMOR EL25 MACHINE AND VICE TUBE BENDERS	220	IMPERIAL GAUGES & HOSES	209
FLEXI-LITE SLAB KIT	38, 97	HILMOR EL25 MACHINE, VICE, FORMERS	220	IMPERIAL KWIK COUPLER	200
FLEXI-LITE SLAB KIT - 3 FEET	38, 97	HILMOR FC10 CRIMPING TOOL	241	IMPERIAL OIL PUMPS & ADAPTOR KITS	185
FLEXI-LITE SLAB KIT - 3 FEET - EXTRA LARGE	38, 97	HILMOR FS FLARING AND SWAGING	223	IMPERIAL REFRIGERANT CHARGING & RECOVERY	201
FLEXI-LITE SLAB KIT - EXTRA LARGE	38, 97	HILMOR FTO FLARING	222	IMPERIAL TESTING & SERVICE TOOLS	194
FLEXIBLE ASHP HOSE PAIR	101	HILMOR H48BVEB VACUUM - 48" HOSES	216	IMPERIAL TOOL BAGS	195
FLEXIBLE HOSE KIT	37	HILMOR H48BVES3 SET OF 3 - 48" HOSES	216	IMPERIAL TUBE BENDERS	185
FLOW PLUS CONDENSATE DRAIN PAN TABLETS	70	HILMOR H60BVEB BALL VALVE - 60" HOSES	216	IMPERIAL TUBE CUTTERS	182
FOAM INSULATION TAPE	75	HILMOR H60BVES4 SET OF 3 - 60" HOSES	216	IMPERIAL TUBE DEBURRING	195
FOAM SEALANT - 355ML	92	HILMOR HIL-GLM-15-22 HAND TUBE BENDERS	221	IMPERIAL VAK-CHECK	211
FOAMING ALKALINE BASED PRE-MIXED COIL CLEANER	56	HILMOR HKFS FOLDING HEX KEY SET INCH	236	INDOOR & OUTDOOR COIL CLEANER	56
FOCUS & STROBE	62	HILMOR HKFSM FOLDING HEX KEY SET METRIC	236	INFRARED SENSOR CO2 REFRIGERANT LEAK DETECTOR	162
FUCHS RENISO C85 E	11, 135	HILMOR HKSBE BALL END HEX KEY SET METRIC	236	INFRARED SENSOR LEAK DETECTOR	160
FUCHS RENISO PAG 100	11, 135	HILMOR HKSS BALL END HEX KEY SET INCH	236	INSIDE ELBOW 90 DEGREE	37
FUCHS RENISO TRITON SE 170	11, 135	HILMOR LP85 PLIERS	240	INSTA-CHARGE	74
FUCHS RENISO TRITON SE 55	11, 135	HILMOR LP95 PLIERS	240	ISO CUBE NATURAL RUBBER PADS - 100MM	40
FUCHS RENISO TRITON SE55	11, 135	HILMOR MT9IN16 9 IN 1 MULTI-TOOL	234	ISO CUBE NATURAL RUBBER PADS- 460MM	40
FUCHS RENISO TRITON SEZ 22	11, 135	HILMOR MTR91 RATCHETING MULTI-TOOL	235	K-KLAMP PIPE AND INSULATION CLAMP	7, 44, 131
FUCHS RENISO TRITON SEZ 32	11, 135	HILMOR MTS 6 IN 1 STUBBY MULTI-TOOL	235	KEYHOLE BRAZE BARRIER MAT	75, 90
FUCHS RENISO TRITON SEZ 68	11, 135	HILMOR PBTGP12 PLIERS	239	KLO-SHURE	7, 44
FUCHS RENISON TRITON SEZ 32	11, 135	HILMOR PBTGP8 PLIERS	239	LARGE PROTECTIVE HOUSING	10
FUCHS RENISON TRITON SEZ 68	11, 135	HILMOR POCCKET SIZE DEBURRING TOOL SWAGING	224	LEAK DETECTION	155
FULL UNION ACCESS FITTING	49	HILMOR PTC PLASTIC TUBE CUTTER	228	LEAK DETECTOR	156
FUSED SPUR METAL CLAD	89, 132	HILMOR PTCRB PLASTIC TC REP BLADE	228	LEAK SEEK - BUBBLE UP DETECTOR SPRAY	57, 105
FUSED SPUR METAL CLAD - WITH BACK BOX	89, 132	HILMOR REPLACEMENT DEBURRER	227	LIGHTWEIGHT TRAY	31
FUSED SPUR PLASTIC - WITH NEON	89, 132	HILMOR RPPTC238 TUBE CUTTER	229	LINE PIERCING VALVE	71
FUSED SPUR PLASTIC - WITHOUT NEON	89, 132	HILMOR RPTC158 RAT TC REP BLADE	229	LINE SET ADAPTOR	58
G2G GREEN 1 LITRE PRE-MIXED COIL CLEANER SPRAY	105	HILMOR RPTC238RB RAT TC REP BLADE	229	LINE TAP VALVE	74
GAUGES & HOSES	209	HILMOR SD5PC SCREWDRIVER	233	LIQUID COIL CLEANER WITH DISINFECTANT	56
GREASE BUSTER LEANER & DEGREASER	57	HILMOR SD7PC SCREWDRIVER	233	LITTLE GIANT AUTOMATIC POOL COVER PUMP	78, 85
GRIP FIT CLAMP	43	HILMOR SDPHRS13 SCREWDRIVER	231	LITTLE GIANT DRAINAGE BASEMENT PUMP	85
GRIP- CUT OPEN MESH SAND SCREEN CLOTH	75, 90	HILMOR SDPHRS2 SCREWDRIVER	231	LITTLE GIANT MAGNETIC DRIVE PUMP	79
HALF UNION ACCESS FITTING	49	HILMOR SDPHRS24 SCREWDRIVER	231	LITTLE GIANT PARTS WASHER PUMP	78
HAND HELD SPRAYER	57	HILMOR SDPHRS27 SCREWDRIVER	231	LITTLE GIANT SMALL SUBMERSIBLE PUMP	78
HEATED PENTODE™ REFRIGERANT LEAK DETECTOR	159	HILMOR SDPHRS36 SCREWDRIVER	231	LONG FLAT ELBOW 90 DEGREE	37
HEATED PENTODE™ SENSOR FOR ZX-1A	159	HILMOR SDPS SCREWDRIVER	232	LONG SPRING CHANNEL NUT	126
HEAVY DUTY CONDENSING COIL CLEANER	56	HILMOR SDSLCTRS146 SCREWDRIVER	230	LOOSE BOLT SHIELD ANCHOR	128
HEX SET 25MM	127	HILMOR SDSLCTRS3163 SCREWDRIVER	230	M6 STUD CLIP	47
HEXAGONAL NUT	126	HILMOR SDSLCTRS3166 SCREWDRIVER	230	MAINTENANCE KIT (3 TIPS WITH PROTECTORS)	158
HIGH TEMPERATURE & PRESSURE RELIEF PUMP	22, 83	HILMOR SDSLKTRRS14112 SCREWDRIVER	230	MAINTENANCE KIT 5 X FILTERS AND 3 X O RINGS	160
HIGH-PRESSURE REPLACEMENT PUMP	6	HILMOR SDSLKTRRS144 SCREWDRIVER	230	MALE ADAPTOR C X MALE NPT COPPER FITTING	53
HILMOR CM A-FRAME BENDER	220	HILMOR SDSLKTRRS388 SCREWDRIVER	230	MANIFOLD DIAPHRAGM REPAIR KIT	207
HILMOR 9IN1SV 9 IN 1 MULTI-TOOL	234			MANIFOLD NO SIGHT GLASS	205
HILMOR A FRAME BENDER FORMERS AND GUIDES	220			MANIFOLD WITH SIGHT GLASS	205
HILMOR AW12 WRENCH	238			MANIFOLDS	203

ITEM	PAGE	ITEM	PAGE	ITEM	PAGE
MAP+ PROPANE, PROPENE & DIMETHYL ETHER MIXTURE	58, 59	REDUCER JOINT	37	T JOINT	37
MAT	113	REDUCER TEE CXC COPPER FITTING	54	TANGENTIAL FAN MOTOR	8
METAL TRAY	31, 97	REFRIGERANT WEIGHING SCALES	163	TEK SCREW	127
MINI FLOWWATCH 2	21	REFRIGERATION	6	THE PURIFIER	63
MINI PUMP	21	REPLACEMENT GASKET ONLY	71	THREADED ROD	122
MINI PUMP WITH TRUNKING	21	REPLACEMENT HANGING HOOK	207	THREADED ROD HANGER	43
MIRROR	59, 91	REPLACEMENT HEAD	59	THREADED TEE FITTING ACCESS FITTING	49
MOUNTING BLOCKS	39	REPLACEMENT HI & LO KNOB KIT WITH STEMS	207	THROUGH-THE-WALL AC	42
NICKLE-METAL HYDRIDE (NIMH) BATTERY PACK	159	REPLACEMENT ROD ASSEMBLY	74	TIF "SLIMLINE" REFRIGERANT SCALE	169
NITROGEN PURGE TOOL	59	REPLACEMENT SENSOR	162	TIF CHARGING / RECOVERY SCALE	168
NON-RETURN CHECK VALVE	23, 87	REPLACEMENT SHUT -OFF STEM	74	TIF COMPACT REFRIGERANT SCALE	165
NON-RETURN VALVE	93	REPLACEMENT STEEL NEEDLE AND GASKET	71	TIF DUAL RANGE COMPACT REFRIGERANT SCALE	164
OIL & LUBRICANT	134	REPLACEMENT VAC & REF KNOB KIT WITH STEMS	207	TIF ELECTRONIC LEAK DETECTOR	105
OTHER PUMPS	77	REPLACEMENT VAC, REF, HT, LO, KNOB KIT	207	TIF HEAVY-DUTY ALUMINIUM SCALE	166
OUTSIDE ELBOW 90 DEGREE	37	REPLACEMENT VALVE CORE TOOL ACCESS FITTING	49	TOOLS	143
P TRAP COPPER FITTING	52	REUSABLE HOSE	65	TWIN FAST SCREW	127
PAD	40	RG 3000 E PROMAX ULTRA COMPACT RECOVERY UNIT	148	TYPE 1 BRACKET	27
PENNY WASHER	125	ROBINAIR 2-WAY MANIFOLD	204	TYPE 2 BRACKET	28, 96
PIPE CLAMP - HOSE CONNECTOR	93	ROBINAIR COOLTECH VACUUM PUMP	172	TYPE 3 BRACKET	29
PIPE CLAMP	45, 93, 129, 130	ROBINAIR HYDRAULIC PIPE EXPANDER	180	U-TYPE STRAP COPPER FITTING	53
PIVOT - 5 LED WORK LIGHT	61	ROBINAIR HYDRAULIC PIPE EXPANDER SET	180	ULTRALITE EQUIPMENT PAD	38
PIVOT 33 - 28 LED FRONT LIGHT / 5 LED TOP	61, 90	ROBINAIR VACUMASTER VACUUM PUMP	173	ULTRAVIOLET LIGHT	62
PIVOT MINI - 18 LED FRONT LIGHT / 3 LED TOP	61, 90	ROOFING NUT AND BOLT	126	UNIVERSAL COPPER SPUN DRIER	59
PLAIN BRAZE BARRIER MAT 18" X 18"	75, 90	RPC CHANNEL CLIP	46	UNIVERSAL MULTI-FIT FAN MOTOR	8
PLAIN CHANNEL NUT	126	RPC INSULCLIPS	46	UNIVERSAL REMOTE CONTROLLER	42
PLASTER BOARD SCREW 15MM	127	RUBBER ANTI-VIBRATION PAD	40	VACUMASTER ROBINAIR VACUUM PUMP 5CFM	174
PLASTIC END CAPS - 41MM X 21MM	122	RUBBER AVM PAD	39	VACUUM HOSES 3/8" X 3/8" (YELLOW)	206
PLASTIC PIPE	93	RUBBER BOOTS KIT - BLUE & RED	207	VACUUM PUMPS	171
PLASTIC PIPE CLIP	93	SAE FLARE CAP 1/4 ACCESS FITTING	49	VALVE FOR DLT LINE TAPS	74
PLUG BRASS FITTING	48	SEEKER MAX UV LED RECHARGE CIRCULAR SPOTLIGHT	62	VIBRATION ABSORBER	7
PLUG SOCKET - 10 AMP	132	SEEKER MINI UV LED CIRCULAR SPOTLIGHT	62	WALL COVER	37
PLUG SOCKET - 10 AMP	89	SELF-SEALING PIPE ADAPTOR	23, 87	WALL PLUG	127
PLUG TOP - 13 AMP	89, 132	SHAKE PROOF WASHER	125	WALL ROSETTE	37
PORTABLE (COOLING)	42, 88	SHORT FORGED FLARE NUT BRASS FITTING	48	WEDGE NUTS	126
PORTABLE (HEAT PUMP)	42, 88	SHORT MACHINE FLARE NUT BRASS FITTING	48	WHITE SILICONE SEALANT	69
PORTABLE HAND TORCH	76	SINGLE GAUGE	207	WINDOW BRACKET	121
PRE SLIT AND SEAL INSULATION	102	SINGLE HINGED PIPE CLAMP	45, 131	WOODEN CONDENSING GUARD	26, 103
PRE SLIT AND SEAL INSULATION	102	SINGLE HOSES	206	WYPALL PLUS TOWELS - WHITE	68, 91
PREMIUM HIGH VACUUM PUMP OIL	135, 176	SINGLE MOUNTING PLATE	113, 114		
PRESSURE RELIEF AND BOILER CONDENSATE PUMP	22, 83	SLEEVED PVC COATED INSULATION KIT	88, 102		
PRO TITE SQUEEZE TUBE - 39ML	69	SLIM DUCT CUTTER	35		
PRO UNIVERSAL PRE-MIXED COIL CLEANER	56	SLIMDUCT TRUNKING	32, 33, 34, 35, 36		
PRO-BUBBLE LEAK DETECTOR SPRAY	68	SLIMDUCT - TIE CLIP	36		
PRO-FIT	72	SLOTTED CHANNEL	120		
PRO-GREEN 5 LITRE CONCENTRATED COIL CLEANER	56, 105	SMALL PROTECTIVE HOUSING	10		
PRO-TREAT 151 PREMIUM DRAIN PAN TABLETS	70	SMELL BUSTER	57		
PROMAX MINIMAX COMPACT RECOVERY UNIT	150	SOAKAWAY KIT	86		
PROMAX RECOVERY UNIT - 110V 50-60HZ	152	SOCKET BOLT	128		
PROMAX RECOVERY UNIT - 240V 50-60HZ	152	SOFFIT INLET	37		
PROMAX ULTRA COMPACT RECOVERY UNI	148	SOLDER TEE FITTING ACCESS FITTING	49		
PROTECTION FLEECE - 2000MM X 1000MM	111, 113	SOLVENT CEMENT	93		
PULL A SPOUT OILER - 4OZ (118ML)	68	SPARK-KEY TORCH IGNITOR	76		
PUMP HOUSE 0.8 LITRE TANK PUMP	82	SPIN	181		
PUMP HOUSE 0.8 LITRE TANK PUMP WITH COVER	82	SQUARE PLATE WASHER	125		
PUMP HOUSE 2 LITRE TANK PUMP	82	STAINLESS FLOOR BRACKET KIT FOR DRIP TRAYS	99		
PUMP HOUSE 20 LITRE PUMP	84	STAINLESS STEEL BRACKETS	31, 99		
PUMP HOUSE 30 LITRE PUMP	84	STANDARD HOSE SET (RED, YELLOW, BLUE)	206		
PURLING CLIP - PULL ON - M10	121	STRAIGHT COUPLER (45° FLARE)	206		
PURLING CLIP - PULL ON - M8	121	STRAIGHT COUPLER CXC COPPER FITTING	51		
PURLING CLIP Z10 BEAM CLAMP	121	STRAIGHT SOLDER FITTING ACCESS FITTING	49		
PVC COATED WEATHER & WATERPROOF INSULATION	101	STRAP ON BOSS	94		
PVC COATED WEATHERPROOF INSULATION TAPE	101, 102	STRAP ON BOSS - 110MM PVCU	94		
PVCU	94	STUD CONNECTOR	127		
QUICK SLING STAND - MEDIUM	41	STUDDING CAPS	122		
QUICK SLING STAND - HIGH	41	STUDDING CLIP	47		
QUICK SLING STAND - LOW	41	SUPER CHANGE - UP TO 6 TONS	64		
QUICK TAP	71	SUPER SEAL	63, 64, 105		
R410A & R32 TRANSITIONAL FITTING BRASS FITTING	48, 65	SURE SHOT REPLACEMENT CARTRIDGE	66		
RECHARGEABLE BATTERIES (2 EACH)	161	SURE SHOT SEALANT ADVANCED	66		
RECOVERY MACHINES	145	SWITCHES	89, 132		
REDUCED COUPLER COPPER FITTING	52	SWIVEL TEE	49		
REDUCED COUPLER FXC COPPER FITTING	52	T BRACKET	121		

INDEX BY CODE



CODE	DESCRIPTION	PAGE	CODE	DESCRIPTION	PAGE	CODE	DESCRIPTION	PAGE
940	SURE SHOT 1/4" SAE REUSABLE HOSE	66	1891089	HILMOR SDPS SCREWDRIVER	232	230-DE3	DUCT END	37
980	FLASH - UP TO 5 TONS (17KW)	65	1891258	HILMOR DBURPS DEBURRING TOOL	242	230-DE3W	DUCT END	37
981	SUPER CHANGE - UP TO 6 TONS	64	1891259	HILMOR MTR91 RATCHETING MULTI-TOOL	235	230-DE4	DUCT END	37
984	SURE SHOT REPLACEMENT CARTRIDGE	66	1891286	HILMOR SDSLCTRS388 SCREWDRIVER	230	230-DE4W	DUCT END	37
985	FLEXI INJECT SEALANT ADVANCED	66	1891287	HILMOR SDSLCTRS3163 SCREWDRIVER	230	230-EB3	INSIDE ELBOW 90 DEGREE	37
1002	HAND HELD SPRAYER	57	1891288	HILMOR SDSLCTRS3166 SCREWDRIVER	230	230-EB3W	INSIDE ELBOW 90 DEGREE	37
1714	FOAM SEALANT - 355ML	92	1891289	HILMOR SDSLCTRS146 SCREWDRIVER	230	230-EB4	INSIDE ELBOW 90 DEGREE	37
1724	FOAM SEALANT - 591ML	92	1891290	HILMOR SDPHRS13 SCREWDRIVER	231	230-EB4W	INSIDE ELBOW 90 DEGREE	37
2601	COMPRESSION SPRAYER - 1 GALLON	57	1891351	HILMOR MTS 6 IN 1 STUBBY MULTI-TOOL	235	230-EIN3	OUTSIDE ELBOW 90 DEGREE	37
2602	COMPRESSION SPRAYER - 2 GALLON	57	1891352	HILMOR SDSLKTSS144 SCREWDRIVER	230	230-EIN3W	OUTSIDE ELBOW 90 DEGREE	37
2603	COMPRESSION SPRAYER - 3 GALLON	57	1891355	HILMOR SDSLKTSS1412 SCREWDRIVER	230	230-EIN4	OUTSIDE ELBOW 90 DEGREE	37
16500	PLAIN BRAZE BARRIER MAT 18" X 18"	75, 90	1891356	HILMOR SDSLKTSS144 SCREWDRIVER	230	230-EIN4W	OUTSIDE ELBOW 90 DEGREE	37
16510	KEYHOLE BRAZE BARRIER MAT - 18" X 18"	75, 90	1891358	HILMOR SDSLKTSS166 SCREWDRIVER	230	230-FB3	FLAT BEND 90 DEGREE	37
20122	REUSABLE HOSE	65	1891391	HILMOR SDPHRS2 SCREWDRIVER	231	230-FB3W	FLAT BEND 90 DEGREE	37
20128	R410A & R32 TRANSITIONAL FITTING BRASS FITTING	48, 65	1891392	HILMOR SDPHRS24 SCREWDRIVER	231	230-FB4	FLAT BEND 90 DEGREE	37
51105	CLIPLIGHT PAO 68 OIL	67	1891393	HILMOR SDPHRS27 SCREWDRIVER	231	230-FB453	FLAT BEND 45 DEGREE	37
51110	CLIPLIGHT PAO 68 OIL	67	1891394	HILMOR SDPHRS36 SCREWDRIVER	231	230-FB453W	FLAT BEND 45 DEGREE	37
51111	CLIPLIGHT PAO 68 OIL & DYE	67	1891397	HILMOR SDBT84 SCREWDRIVER	231	230-FB454	FLAT BEND 45 DEGREE	37
51112	CLIPLIGHT HYBRID A/C COMPRESSOR OIL	67	1891472	HILMOR HKFSM FOLDING HEX KEY SET METRIC	236	230-FB454W	FLAT BEND 45 DEGREE	37
11112	CLIPSTRIP - POCKET LIGHT	61	1826598	HILMOR CBKRB TUBE BENDER KITS	217	230-FB4W	FLAT BEND 90 DEGREE	37
11113	CLIPSTRIP - AQUA POCKET LIGHT	61	1935917	HILMOR H48BVES3 SET OF 3 - 48" HOSES	216	230-FH3-KIT	FLEXIBLE HOSE KIT	37
11114	PIVOT - 5 LED WORK LIGHT	61	1935918	HILMOR H48BVBV VACUUM - 48" HOSES	216	230-FH3W-KIT	FLEXIBLE HOSE KIT	37
11114	PIVOT - 5 LED WORK LIGHT	90	1935924	HILMOR H60BVES3 SET OF 3 - 60" HOSES	216	230-FH4-KIT	FLEXIBLE HOSE KIT	37
11115	PIVOT MINI - 18 LED FRONT LIGHT / 3 LED TOP	61, 90	1935925	HILMOR H60BVES4 SET OF 4 - 60" HOSES	216	230-FH4W-KIT	FLEXIBLE HOSE KIT	37
11116	CLIPSTRIP - POCKET LIGHT	61	1935926	HILMOR H60BVBV BALL VALVE - 60" HOSES	216	230-FR3	FLAT ROSETTE	37
11117	PIVOT MINI - 18 LED FRONT LIGHT / 3 LED TOP	61, 90	1937816	HILMOR HKSBEM BALL END HEX KEY SET METRIC	236	230-FR3W	FLAT ROSETTE	37
11201	FOCUS & STROBE	62	1937819	HILMOR MT9IN16 9 IN 1 MULTI-TOOL	234	230-FR4	FLAT ROSETTE	37
154724	NON-RETURN CHECK VALVE - 3/8" (Ø.5MM)	23	1963826	HILMOR DAJTW WRENCH	237	230-FR4W	FLAT ROSETTE	37
410212	THE PURIFIER - REPLACEMENT BULB	63	1964041	HILMOR DCS SWAGING	225	230-LFB3	LONG FLAT ELBOW 90 DEGREE	37
511046	CLIPLIGHT PAG & DYE (46 VISCOSITY)	67	1964042	HILMOR CSEH4 EXPANDER HEAD SWAGING	225	230-LFB3W	LONG FLAT ELBOW 90 DEGREE	37
511102	CLIPLIGHT ESTER & DYE (100 VISCOSITY)	67	1964043	HILMOR CSEH4 EXPANDER HEAD SWAGING	225	230-LFB4	LONG FLAT ELBOW 90 DEGREE	37
511150	CLIPLIGHT PAG & DYE (150 VISCOSITY)	67	600360382	FUCHS RENISO C85 E	11, 135	230-LFB4W	LONG FLAT ELBOW 90 DEGREE	37
729037	KLO-SHURE 3/8" ID X 1-1/2"	7, 44	600646509	FUCHS RENISON TRITON SE55	11, 135	230-RJ4	REDUCER JOINT	37
729050	KLO-SHURE 1/2" ID X 1-1/2"	7, 44	600669812	FUCHS RENISON TRITON SEZ 32	11, 135	230-RJ4W	REDUCER JOINT	37
729062	KLO-SHURE 5/8" ID X 1-1/2"	7, 44	600680107	FUCHS RENISO TRITON SEZ 68	11, 135	230-SF3	SOFFIT INLET	37
729087	KLO-SHURE 7/8" ID X 1-1/2"	7, 44	600680442	FUCHS RENISO TRITON SE 170	11, 135	230-SF3W	SOFFIT INLET	37
729112	KLO-SHURE 1-1/8" ID X 1-1/2"	7, 44	600741105	FUCHS RENISO C85 E	11, 135	230-SF4	SOFFIT INLET	37
729137	KLO-SHURE 1-3/8" ID X 1-1/2"	7, 44	600756512	FUCHS RENISO PAG 100	11, 135	230-SF4W	SOFFIT INLET	37
729162	KLO-SHURE 1-5/8" ID X 1-1/2"	7, 44	601231254	FUCHS RENISON TRITON SEZ 68	11, 135	230-TJ4	T JOINT	37
729212	KLO-SHURE 2-1/8" ID X 1-1/2"	7, 44	601231278	FUCHS RENISO TRITON SE 170	11, 135	230-TJ4W	T JOINT	37
729262	KLO-SHURE 2-5/8" ID X 1-1/2"	7, 44	601231292	FUCHS RENISO TRITON SEZ 22	11, 135	230-WC3	WALL COVER	37
729312	KLO-SHURE 3-1/8" ID X 1-1/2"	7, 44	601231339	FUCHS RENISO TRITON SEZ 32	11, 135	230-WC3W	WALL COVER	37
729412	KLO-SHURE 4-1/8" ID X 1-1/2"	7, 44	601231414	FUCHS RENISO TRITON SE 55	11, 135	230-WC4	WALL COVER	37
900008	CLIPLIGHT A/C DYE	67	6-9718	FOAM INSULATION TAPE	75	230-WC4W	WALL COVER	37
909008	CLIPLIGHT MULTI-PURPOSE DYE	67	7-10	CLEAR 1" X 15 METRES CLEAR VINYL HOSE	24	230-WR3	WALL ROSETTE	37
911011	CLIPLIGHT PAG & DYE (100 VISCOSITY)	67	7-12	CLEAR 1/2" X 30 METRES CLEAR VINYL HOSE	24	230-WR3W	WALL ROSETTE	37
927033	HOSE CLIP - 9.5MM (3/8")	67	7-14	CLEAR 1/4" X 30 METRES CLEAR VINYL HOSE	24	230-WR4	WALL ROSETTE	37
990008	CLIPLIGHT RADIATOR DYE	67	7-34	CLEAR 3/4" X 30 METRES CLEAR VINYL HOSE	24	230-WR4W	WALL ROSETTE	37
1838947	HILMOR FS FLARING AND SWAGING	223	7-38	CLEAR 3/8" X 30 METRES CLEAR VINYL HOSE	24	24-458	PIVOT 33 - 28 LED FRONT LIGHT / 5 LED TOP	61, 90
1838952	HILMOR FTO FLARING	222	7-4000	CLEAR SILICONE SEALANT T - 305ML	69	24-460	PIVOT 33 - 28 LED FRONT LIGHT / 5 LED TOP	61, 90
1839015	HILMOR CS SWAGING	224	7-4100	WHITE SILICONE SEALANT - 305ML	69	3IN1	3 IN 1 MULTIPURPOSE OIL	61
1839026	HILMOR TB31638 TUBE BENDERS	218	7-58	CLEAR 5/8" X 30 METRES CLEAR VINYL HOSE	24	5-05790	WYPALL PLUS TOWELS - WHITE	68, 91
1839027	HILMOR TB31612 TUBE BENDERS	220	75-20-100	CABLE 2 CORE Ø7.5MM	133	525-TORCH	PORTABLE HAND TORCH	76
1839032	HILMOR CBK TUBE BENDER KITS	217	170AIRFAN	THE PURIFIER - REPLACEMENT FAN	63	6-202-1	DIVERSI-GUM SEALING COMPOUND 450G SLUG	69, 92
1839048	HILMOR HKFS FOLDING HEX KEY SET INCH	236	170AIRP	THE PURIFIER - FRESH AIR OZONE MACHINE	63	6-202-2	DIVERSI-GUM SEALING COMPOUND 900G SLUG	69, 92
1839049	HILMOR HKSS BALL END HEX KEY SET INCH	236	170AIRPCB	THE PURIFIER - REPLACEMENT CIRCUIT BOARD	63	6-330	CORK INSULATION TAPE	75
1839052	HILMOR DBUR DEBURRING TOOL	242	1839016	HILMOR CSEH38 EXPANDER HEAD SWAGING	224	640-AF-2	ALUMINIUM FOIL TAPE	75
1839053	HILMOR 9INISV 9 IN 1 MULTI-TOOL	234	1839017	HILMOR CSEH38 EXPANDER HEAD SWAGING	224	6E-CIA-SFS	LITTLE GIANT DRAINAGE BASEMENT PUMP	85
1885363	HILMOR DC88 HILMOR PLIERS	241	1839018	HILMOR CSEH12 EXPANDER HEAD SWAGING	224	701-030	HOSE CONNECTOR - NYLON 1/4"	24
1885369	HILMOR AW16 WRENCH	238	1839019	HILMOR CSEH58 EXPANDER HEAD SWAGING	224	701-032	HOSE CONNECTOR - NYLON 3/8"	24, 87
1885370	HILMOR AW18 WRENCH	238	1839020	HILMOR CSEH34 EXPANDER HEAD SWAGING	224	701-038	HOSE T CONNECTOR - NYLON 3/8"	24, 87
1885381	HILMOR C81858 TUBE CUTTER	226	1839021	HILMOR CSEH78 EXPANDER HEAD SWAGING	224	805CLN	CLIPLIGHT DYE CLEANER	67
1885382	HILMOR TC181 TUBE CUTTER	226	1839022	HILMOR CSEH18 EXPANDER HEAD SWAGING	224	84DOPLUS	SEEKER MINI UV LED CIRCULAR SPOTLIGHT	62
1885383	HILMOR TC18118 TC TUBE CUTTER	226	1839023	HILMOR CSEH38 EXPANDER HEAD SWAGING	224	87DOPLUS	SEEKER MAX UV LED RECHARGE CIRCULAR SPOTLIGHT	62
1885384	HILMOR TC18138 TUBE CUTTER	227	1839024	HILMOR CSEH58 EXPANDER HEAD SWAGING	224	900006B	CLIPLIGHT A/C DYE	67
1885385	HILMOR TC18134 TUBE CUTTER	227	1839025	HILMOR CSE COMPACT SWAGE BODY KIT SWAGING	224	900012B	CLIPLIGHT A/C DYE	67
1885386	HILMOR SMALL TUBING CUTTER WHEELS 2PK	227	1891258	HILMOR POCKET SIZE DEBURRING TOOL SWAGING	224	909006B	CLIPLIGHT MULTI-PURPOSE DYE	67
1885387	HILMOR TUBING CUTTER WHEELS 2PK	227	1964042	HILMOR CSEH4 EXPANDER HEAD SWAGING	224	909012B	CLIPLIGHT MULTI-PURPOSE DYE	67
1885388	HILMOR PTC PLASTIC TUBE CUTTER	228	1964043	HILMOR CSEH218 EXPANDER HEAD SWAGING	224	944-KIT	SUPER SEAL LEAK SEALANT MEDIUM SYSTEMS	105
1885390	HILMOR PTCRB PLASTIC TC REP BLADE	228	1V-PW	LITTLE GIANT PARTS WASHER PUMP	78	944KIT	SUPER SEAL ADVANCED	64
1885393	HILMOR RPTC158 TUBE CUTTER	229	20128	1/4" TO 5/16" BRASS ADAPTOR	206	946KIT	SUPER SEAL PREMIUM WITH PRO A/C STOP LEAK	63
1885394	HILMOR RPTC158RB RAT TC REP BLADE	229	21024TCD	HILMOR REPLACEMENT DEBURRER	227	947-KIT	SUPER SEAL LEAK SEALANT SMALL SYSTEM	105
1885395	HILMOR RPTC238 TUBE CUTTER	229	230-AFB3	ADJUST FLAT BEND 45-90 DEGREE	37	947KIT	SUPER SEAL ADVANCED UP TO 15 TONS (6KW)	64
1885396	HILMOR RPTC238RB RAT TC REP BLADE	229	230-AFB3W	ADJUST FLAT BEND 45-90 DEGREE	37	948-KIT	SUPER SEAL LEAK SEALANT LARGE SYSTEMS	105
1885399	HILMOR LP85 PLIERS	240	230-AFB4	ADJUST FLAT BEND 45-90 DEGREE	37	948KIT	SUPER SEAL ADVANCED - 5 TONS (17KW)	64
1885411	HILMOR LP95 PLIERS	240	230-AFB4W	ADJUST FLAT BEND 45-90 DEGREE	37	971KIT	SUPER SEAL TOTAL - UP TO 15 TONS (6KW)	64
1885412	HILMOR DCP6 PLIERS	241	230-CP3	CONNECTION PIECE	37	972KIT	SUPER SEAL TOTAL - 15 TO 5 TONS (5-17KW)	64
1885422	HILMOR AW12 WRENCH	238	230-CP3W	CONNECTION PIECE	37	973KIT	DRY R MOISTURE ELIMINATOR	70
1885424	HILMOR WS8 WIRE STRIPPERS	242	230-CP4	CONNECTION PIECE	37	976KIT	SUPER SEAL PLATINUM DRY R & FLASH UV DYE	63
1885427	HILMOR WS6 WIRE STRIPPERS	242	230-CP4W	CONNECTION PIECE	37	98084KIT	FLASH KIT - 3 CANS OF FLASH	65
1885429	HILMOR FC10 CRIMPING TOOL	241	230-D3	DUCT - 70MM - SOLD IN 2 METRE LENGTHS	37	98087KIT	FLASH KIT - 3 CANS OF FLASH	65
1885432	HILMOR UKB UTILITY KNIFE BLADES 5PK	243	230-D3W	DUCT - 70MM - SOLD IN 2 METRE LENGTHS	37	983KIT	SURE SHOT SEALANT ADVANCED	66
1885433	HILMOR UKHF UTILITY KNIFE	243	230-D4	DUCT - 105MM - SOLD IN 2 METRE LENGTHS	37	990006B	CLIPLIGHT RADIATOR DYE	67
1890996	HILMOR PBTGP8 PLIERS	239	230-D4W	DUCT - 105MM - SOLD IN 2 METRE LENGTHS	37	990012B	CLIPLIGHT RADIATOR DYE	67
1890998	HILMOR PBTGP12 PLIERS	239	230-DC3	DUCT CAP	37	AC	AC	19
1890999	HILMOR CBR8M REV BEND ATT TUBE BENDER	217	230-DC3W	DUCT CAP	37	ACID-ELIM	ACID ELIMINATOR - 115ML	70
1891087	HILMOR SDS5PC SCREWDRIVER	233	230-DC4	DUCT CAP	37	ADAP-1	CONDENSATE DRAIN ADAPTOR	23, 87
1891088	HILMOR SD7PC SCREWDRIVER	233	230-DC4W	DUCT CAP	37	ADAP-CAC-L	CASSETTE ADAPTOR - LARGE	23

CODE	DESCRIPTION	PAGE	CODE	DESCRIPTION	PAGE	CODE	DESCRIPTION	PAGE
ADAP-CAC-M	CASSETTE ADAPTOR - MEDIUM	23	C165-0059-PH	REDUCED COUPLER COPPER FITTING	52	C290-0002-PH	45 DEGREE ELBOW CXC COPPER FITTING	51
ADAP-CAC-S	CASSETTE ADAPTOR - SMALL	23	C165-0090-PH	STRAIGHT COUPLER CXC COPPER FITTING	51	C290-0025-PH	45 DEGREE ELBOW CXC COPPER FITTING	51
ADAP-CAC-X	CASSETTE ADAPTOR - MULTIPACK	23	C165-0093-PH	REDUCED COUPLER COPPER FITTING	52	C290-0050-PH	45 DEGREE ELBOW CXC COPPER FITTING	51
AER-B-500	LEAK SEEK - BUBBLE UP DETECTOR SPRAY	57, 105	C165-0094-PH	REDUCED COUPLER COPPER FITTING	52	C290-0090-PH	45 DEGREE ELBOW CXC COPPER FITTING	51
AER-C-600	CASE CLEAN - CASE, FASCIA & GLASS CLEANER	57	C165-0100-PH	STRAIGHT COUPLER CXC COPPER FITTING	51	C290-0100-PH	45 DEGREE ELBOW CXC COPPER FITTING	51
AER-D-600	COIL CLEAN - UNIVERSAL COIL CLEANER	57	C165-0107-PH	REDUCED COUPLER COPPER FITTING	52	C290-0150-PH	45 DEGREE ELBOW CXC COPPER FITTING	51
AER-F-600	COIL FOAM - HEAVY DUTY CONDENSER CLEANER	57	C165-0108-PH	REDUCED COUPLER COPPER FITTING	52	C290-0215-PH	45 DEGREE ELBOW CXC COPPER FITTING	51
AER-I-600	COIL CARE - EVAPORATOR CLEANER & DISINFECTANT	57	C165-0149-PH	REDUCED COUPLER COPPER FITTING	52	C290-0295-PH	45 DEGREE ELBOW CXC COPPER FITTING	51
AER-O-500	GREASE BUSTER LEANER & DEGREASER	57	C165-0150-PH	STRAIGHT COUPLER CXC COPPER FITTING	51	C290-0390-PH	45 DEGREE ELBOW CXC COPPER FITTING	51
ANTI-SYPH-KIT	ANTI-SYPHON KIT - 9.5MM (3/8")	87	C165-0159-PH	REDUCED COUPLER COPPER FITTING	52	C290-0520-PH	45 DEGREE ELBOW CXC COPPER FITTING	51
APCP-1700	LITTLE GIANT AUTOMATIC POOL COVER PUMP	78, 85	C165-0160-PH	REDUCED COUPLER COPPER FITTING	52	C290-0650-PH	45 DEGREE ELBOW CXC COPPER FITTING	51
ASHP	ASHP	95	C165-0161-PH	REDUCED COUPLER COPPER FITTING	52	C290-0750-PH	45 DEGREE ELBOW CXC COPPER FITTING	51
ASHP-SOAK	AIR SOURCE HEAT PUMP SOAKAWAY	100	C165-0215-PH	STRAIGHT COUPLER CXC COPPER FITTING	51	C290-0850-PH	45 DEGREE ELBOW CXC COPPER FITTING	51
ATK-1	ACID TEST KIT - AB AND MINERAL OIL	70	C165-0222-PH	REDUCED COUPLER COPPER FITTING	52	C295-0002-PH	45 DEGREE STREET ELBOW FXC COPPER FITTING	51
ATK-1P	ACID TEST KIT - WITH POE OIL	70	C165-0223-PH	REDUCED COUPLER COPPER FITTING	52	C295-0025-PH	45 DEGREE STREET ELBOW FXC COPPER FITTING	51
ATK-4	ACID TEST KIT - AB AND MINERAL OIL	70	C165-0224-PH	REDUCED COUPLER COPPER FITTING	52	C295-0050-PH	45 DEGREE STREET ELBOW FXC COPPER FITTING	51
ATP-C1	INFRARED SENSOR CO2 REFRIGERANT LEAK DETECTOR	162	C165-0295-PH	STRAIGHT COUPLER CXC COPPER FITTING	51	C295-0090-PH	45 DEGREE STREET ELBOW FXC COPPER FITTING	51
ATP-C2	REPLACEMENT SENSOR	162	C165-0304-PH	REDUCED COUPLER COPPER FITTING	52	C295-0100-PH	45 DEGREE STREET ELBOW FXC COPPER FITTING	51
AUDIBLE ALARM	AUDIBLE ALARM FOR ALL PUMPS	23	C165-0305-PH	REDUCED COUPLER COPPER FITTING	52	C295-0150-PH	45 DEGREE STREET ELBOW FXC COPPER FITTING	51
AUDIBLE-ALARM	AUDIBLE ALARM FOR ALL PUMPS	87	C165-0390-PH	STRAIGHT COUPLER CXC COPPER FITTING	51	C295-0215-PH	45 DEGREE STREET ELBOW FXC COPPER FITTING	51
AVM-PAD-1	RUBBER AVM PAD - 330MM	39	C165-0398-PH	REDUCED COUPLER COPPER FITTING	52	C295-0295-PH	45 DEGREE STREET ELBOW FXC COPPER FITTING	51
AVM-PAD-2	RUBBER AVM PAD - 600MM WITH STEEL PLATES	39	C165-0399-PH	REDUCED COUPLER COPPER FITTING	52	C295-0390-PH	45 DEGREE STREET ELBOW FXC COPPER FITTING	51
AVM-PAD-3	RUBBER AVM PAD - 1000MM WITH STEEL PLATES	39	C165-0400-PH	REDUCED COUPLER COPPER FITTING	52	C295-0520-PH	45 DEGREE STREET ELBOW FXC COPPER FITTING	51
AVMB-1	ANTI-VIBRATION MOUNTING BOLTS	30, 99	C165-0401-PH	REDUCED COUPLER COPPER FITTING	52	C295-0650-PH	45 DEGREE STREET ELBOW FXC COPPER FITTING	51
AVMS-1	ANTI-VIBRATION MOUNTING STRIP - RUBBER	39	C165-0620-PH	STRAIGHT COUPLER CXC COPPER FITTING	51	C295-0750-PH	45 DEGREE STREET ELBOW FXC COPPER FITTING	51
AVMS-2	ANTI-VIBRATION MOUNTING STRIP - RUBBER	39	C165-0631-PH	REDUCED COUPLER COPPER FITTING	52	C295-0850-PH	45 DEGREE STREET ELBOW FXC COPPER FITTING	51
AVMS-3	ANTI-VIBRATION MOUNTING STRIP - RUBBER	39	C165-0632-PH	REDUCED COUPLER COPPER FITTING	52	C410-0007-PH	REDUCED COUPLER FXC COPPER FITTING	52
AVMS-4	ANTI-VIBRATION MOUNTING STRIP - RUBBER	39	C165-0633-PH	REDUCED COUPLER COPPER FITTING	52	C410-0032-PH	REDUCED COUPLER FXC COPPER FITTING	52
AVMS-CR-3	ANTI-VIBRATION MOUNTING STRIP - CORK/RUBBER	39	C165-0650-PH	STRAIGHT COUPLER CXC COPPER FITTING	51	C410-0033-PH	REDUCED COUPLER FXC COPPER FITTING	52
AVMS-CR-4	ANTI-VIBRATION MOUNTING STRIP - CORK/RUBBER	39	C165-0662-PH	REDUCED COUPLER COPPER FITTING	52	C410-0058-PH	REDUCED COUPLER FXC COPPER FITTING	52
B-26	FIN BRUSH	60	C165-0663-PH	REDUCED COUPLER COPPER FITTING	52	C410-0059-PH	REDUCED COUPLER FXC COPPER FITTING	52
B-4H	HOSE CLAMP 3/16-5/16	24	C165-0664-PH	REDUCED COUPLER COPPER FITTING	52	C410-0093-PH	REDUCED COUPLER FXC COPPER FITTING	52
B-6H	HOSE CLAMP 1/4-3/8	24, 87	C165-0750-PH	STRAIGHT COUPLER CXC COPPER FITTING	51	C410-0094-PH	REDUCED COUPLER FXC COPPER FITTING	52
BACKPLATE-910-HD	BACK PLATE FOR MOUNTING M8/M10	44, 130	C165-0790-PH	REDUCED COUPLER COPPER FITTING	52	C410-0095-PH	REDUCED COUPLER FXC COPPER FITTING	52
BB-1	BOILER BUOY - CONDENSATE BYPASS VALVE	86	C165-0850-PH	STRAIGHT COUPLER CXC COPPER FITTING	51	C410-0107-PH	REDUCED COUPLER FXC COPPER FITTING	52
BCONDNEUT-20L	PUMP HOUSE 20 LITRE PUMP	84	C165-0852-PH	REDUCED COUPLER COPPER FITTING	52	C410-0108-PH	REDUCED COUPLER FXC COPPER FITTING	52
BCONDNEUT-30L	PUMP HOUSE 30 LITRE PUMP	84	C165-1498-PH	REDUCED COUPLER COPPER FITTING	52	C410-0109-PH	REDUCED COUPLER FXC COPPER FITTING	52
HEATING	BOILER & HEATING	81	C180-0002-PH	190 DEGREE RETURN BEND COPPER FITTING	52	C410-0149-PH	REDUCED COUPLER FXC COPPER FITTING	52
BOSCH CS LD10	LEAK DETECTOR	156	C180-0025-PH	190 DEGREE RETURN BEND COPPER FITTING	52	C410-0159-PH	REDUCED COUPLER FXC COPPER FITTING	52
BOSCH-IR-LD	LEAK DETECTOR	157	C180-0050-PH	190 DEGREE RETURN BEND COPPER FITTING	52	C410-0160-PH	REDUCED COUPLER FXC COPPER FITTING	52
BOSCH RG-4.0A	BOSCH RECOVERY UNIT - 240V 50-60HZ	145	C180-0090-PH	190 DEGREE RETURN BEND COPPER FITTING	52	C410-0161-PH	REDUCED COUPLER FXC COPPER FITTING	52
BOSCH RG-4.0B	BOSCH RECOVERY UNIT - 110V 50-60HZ	145	C180-0100-PH	190 DEGREE RETURN BEND COPPER FITTING	52	C410-0222-PH	REDUCED COUPLER FXC COPPER FITTING	52
C101-0005-PH	MALE ADAPTOR C X MALE NPT COPPER FITTING	53	C180-0150-PH	190 DEGREE RETURN BEND COPPER FITTING	52	C410-0223-PH	REDUCED COUPLER FXC COPPER FITTING	52
C101-0007-PH	MALE ADAPTOR C X MALE NPT COPPER FITTING	53	C180-0215-PH	190 DEGREE RETURN BEND COPPER FITTING	52	C410-0224-PH	REDUCED COUPLER FXC COPPER FITTING	52
C101-0025-PH	MALE ADAPTOR C X MALE NPT COPPER FITTING	53	C180-0295-PH	190 DEGREE RETURN BEND COPPER FITTING	52	C410-0303-PH	REDUCED COUPLER FXC COPPER FITTING	52
C101-0050-PH	MALE ADAPTOR C X MALE NPT COPPER FITTING	53	C180-0390-PH	190 DEGREE RETURN BEND COPPER FITTING	52	C410-0304-PH	REDUCED COUPLER FXC COPPER FITTING	52
C101-0057-PH	MALE ADAPTOR C X MALE NPT COPPER FITTING	53	C235-0001-PH	90 DEGREE ELBOW CXC COPPER FITTING	50	C410-0305-PH	REDUCED COUPLER FXC COPPER FITTING	52
C101-0058-PH	MALE ADAPTOR C X MALE NPT COPPER FITTING	53	C235-0002-PH	90 DEGREE ELBOW CXC COPPER FITTING	50	C410-0306-PH	REDUCED COUPLER FXC COPPER FITTING	52
C101-0100-PH	MALE ADAPTOR C X MALE NPT COPPER FITTING	53	C235-0025-PH	90 DEGREE ELBOW CXC COPPER FITTING	50	C410-0398-PH	REDUCED COUPLER FXC COPPER FITTING	52
C101-0150-PH	MALE ADAPTOR C X MALE NPT COPPER FITTING	53	C235-0050-PH	90 DEGREE ELBOW CXC COPPER FITTING	50	C410-0399-PH	REDUCED COUPLER FXC COPPER FITTING	52
C101-0159-PH	MALE ADAPTOR C X MALE NPT COPPER FITTING	53	C235-0090-PH	90 DEGREE ELBOW CXC COPPER FITTING	50	C410-0400-PH	REDUCED COUPLER FXC COPPER FITTING	52
C101-0215-PH	MALE ADAPTOR C X MALE NPT COPPER FITTING	52, 53	C235-0100-PH	90 DEGREE ELBOW CXC COPPER FITTING	50	C410-0401-PH	REDUCED COUPLER FXC COPPER FITTING	52
C101-0295-PH	MALE ADAPTOR C X MALE NPT COPPER FITTING	52, 53	C235-0150-PH	90 DEGREE ELBOW CXC COPPER FITTING	50	C410-0402-PH	REDUCED COUPLER FXC COPPER FITTING	52
C101-0390-PH	MALE ADAPTOR C X MALE NPT COPPER FITTING	52, 53	C235-0215-PH	90 DEGREE ELBOW CXC COPPER FITTING	50	C410-0531-PH	REDUCED COUPLER FXC COPPER FITTING	52
C105-0025-PH	FEMALE ADAPTOR C X FEMALE NPT COPPER FITTING	53	C235-0295-PH	90 DEGREE ELBOW CXC COPPER FITTING	50	C410-0632-PH	REDUCED COUPLER FXC COPPER FITTING	52
C105-0050-PH	FEMALE ADAPTOR C X FEMALE NPT COPPER FITTING	53	C235-0390-PH	90 DEGREE ELBOW CXC COPPER FITTING	50	C410-0533-PH	REDUCED COUPLER FXC COPPER FITTING	52
C105-0057-PH	FEMALE ADAPTOR C X FEMALE NPT COPPER FITTING	53	C235-0520-PH	90 DEGREE ELBOW CXC COPPER FITTING	50	C410-0662-PH	REDUCED COUPLER FXC COPPER FITTING	52
C105-0058-PH	FEMALE ADAPTOR C X FEMALE NPT COPPER FITTING	53	C235-0650-PH	90 DEGREE ELBOW CXC COPPER FITTING	50	C410-0663-PH	REDUCED COUPLER FXC COPPER FITTING	52
C105-0059-PH	FEMALE ADAPTOR C X FEMALE NPT COPPER FITTING	53	C235-0750-PH	90 DEGREE ELBOW CXC COPPER FITTING	50	C410-0664-PH	REDUCED COUPLER FXC COPPER FITTING	52
C105-0100-PH	FEMALE ADAPTOR C X FEMALE NPT COPPER FITTING	53	C235-0850-PH	90 DEGREE STREET ELBOW FXC COPPER FITTING	50	C410-0754-PH	REDUCED COUPLER FXC COPPER FITTING	52
C105-0107-PH	FEMALE ADAPTOR C X FEMALE NPT COPPER FITTING	53	C242-0001-PH	90 DEGREE LONG TURN ELBOW CXC COPPER FITTING	50	C410-0850-PH	REDUCED COUPLER FXC COPPER FITTING	52
C105-0150-PH	FEMALE ADAPTOR C X FEMALE NPT COPPER FITTING	53	C242-0002-PH	90 DEGREE LONG TURN ELBOW CXC COPPER FITTING	50	C410-0852-PH	REDUCED COUPLER FXC COPPER FITTING	52
C105-0159-PH	FEMALE ADAPTOR C X FEMALE NPT COPPER FITTING	53	C242-0025-PH	90 DEGREE LONG TURN ELBOW CXC COPPER FITTING	50	C410-0854-PH	REDUCED COUPLER FXC COPPER FITTING	52
C105-0215-PH	FEMALE ADAPTOR C X FEMALE NPT COPPER FITTING	53	C242-0050-PH	90 DEGREE LONG TURN ELBOW CXC COPPER FITTING	50	C410-1498-PH	REDUCED COUPLER FXC COPPER FITTING	52
C105-0295-PH	FEMALE ADAPTOR C X FEMALE NPT COPPER FITTING	53	C242-0090-PH	90 DEGREE LONG TURN ELBOW CXC COPPER FITTING	50	C460-0001-PH	EQUAL TEE CXC/CX COPPER FITTING	53
C105-0390-PH	FEMALE ADAPTOR C X FEMALE NPT COPPER FITTING	53	C242-0100-PH	90 DEGREE LONG TURN ELBOW CXC COPPER FITTING	50	C460-0002-PH	EQUAL TEE CXC/CX COPPER FITTING	53
C154-0002-PH	END CAP COPPER FITTING	51	C242-0150-PH	90 DEGREE LONG TURN ELBOW CXC COPPER FITTING	50	C460-0005-PH	REDUCER TEE CXC COPPER FITTING	54
C154-0025-PH	END CAP COPPER FITTING	51	C242-0215-PH	90 DEGREE LONG TURN ELBOW CXC COPPER FITTING	50	C460-0006-PH	REDUCER TEE CXC COPPER FITTING	54
C154-0050-PH	END CAP COPPER FITTING	51	C242-0295-PH	90 DEGREE LONG TURN ELBOW CXC COPPER FITTING	50	C460-0025-PH	EQUAL TEE CXC/CX COPPER FITTING	53
C154-0090-PH	END CAP COPPER FITTING	51	C242-0390-PH	90 DEGREE LONG TURN ELBOW CXC COPPER FITTING	50	C460-0031-PH	REDUCER TEE CXC COPPER FITTING	54
C154-0100-PH	END CAP COPPER FITTING	51	C242-0520-PH	90 DEGREE LONG TURN ELBOW CXC COPPER FITTING	50	C460-0032-PH	REDUCER TEE CXC COPPER FITTING	54
C154-0150-PH	END CAP COPPER FITTING	51	C242-0650-PH	90 DEGREE LONG TURN ELBOW CXC COPPER FITTING	50	C460-0033-PH	REDUCER TEE CXC COPPER FITTING	54
C154-0215-PH	END CAP COPPER FITTING	51	C242-0750-PH	90 DEGREE LONG TURN ELBOW CXC COPPER FITTING	50	C460-0040-PH	REDUCER TEE CXC COPPER FITTING	54
C154-0295-PH	END CAP COPPER FITTING	51	C242-0850-PH	90 DEGREE LONG TURN STREET ELBOW FXF COPPER FITTING	50	C460-0041-PH	REDUCER TEE CXC COPPER FITTING	54
C154-0390-PH	END CAP COPPER FITTING	51	C254-0002-PH	90 DEGREE STREET ELBOW FXF COPPER FITTING	50	C460-0050-PH	EQUAL TEE CXC/CX COPPER FITTING	53
C154-0520-PH	END CAP COPPER FITTING	51	C272-0002-PH	90 DEGREE LONG TURN STREET ELBOW FXF COPPER FITTING	50	C460-0056-PH	REDUCER TEE CXC COPPER FITTING	54
C154-0650-PH	END CAP COPPER FITTING	51	C272-0025-PH	90 DEGREE LONG TURN STREET ELBOW FXF COPPER FITTING	50	C460-0057-PH	REDUCER TEE CXC COPPER FITTING	54
C154-0750-PH	END CAP COPPER FITTING	51	C272-0050-PH	90 DEGREE LONG TURN STREET ELBOW FXF COPPER FITTING	50	C460-0058-PH	REDUCER TEE CXC COPPER FITTING	54
C154-0850-PH	END CAP COPPER FITTING	51	C272-0090-PH	90 DEGREE LONG TURN STREET ELBOW FXF COPPER FITTING	50	C460-0059-PH	REDUCER TEE CXC COPPER FITTING	54
C165-0001-PH	STRAIGHT COUPLER CXC COPPER FITTING	51	C272-0100-PH	90 DEGREE LONG TURN STREET ELBOW FXF COPPER FITTING	50	C460-0066-PH	REDUCER TEE CXC COPPER FITTING	54
C165-0002-PH	STRAIGHT COUPLER CXC COPPER FITTING	51	C272-0150-PH	90 DEGREE LONG TURN STREET ELBOW FXF COPPER FITTING	50	C460-0067-PH	REDUCER TEE CXC COPPER FITTING	54
C165-0007-PH	REDUCED COUPLER COPPER FITTING	52	C272-0215-PH	90 DEGREE LONG TURN STREET ELBOW FXF COPPER FITTING	50	C460-0068-PH	REDUCER TEE CXC COPPER FITTING	54
C165-0025-PH	STRAIGHT COUPLER CXC COPPER FITTING	51	C272-0295-PH	90 DEGREE LONG TURN STREET ELBOW FXF COPPER FITTING	50	C460-0076-PH	REDUCER TEE CXC COPPER FITTING	54
C165-0030-PH	REDUCED COUPLER COPPER FITTING	52	C272-0390-PH	90 DEGREE LONG TURN STREET ELBOW FXF COPPER FITTING	50	C460-0087-PH	REDUCER TEE CXC COPPER FITTING	54
C165-0032-PH	REDUCED COUPLER COPPER FITTING	52	C272-0520-PH	90 DEGREE LONG TURN STREET ELBOW FXF COPPER FITTING	50	C460-0090-PH	EQUAL TEE CXC/CX COPPER FITTING	53
C165-0033-PH	REDUCED COUPLER COPPER FITTING	52	C272-0650-PH	90 DEGREE LONG TURN STREET ELBOW FXF COPPER FITTING	50	C460-0092-PH	REDUCER TEE CXC COPPER FITTING	54
C165-0050-PH	STRAIGHT COUPLER CXC COPPER FITTING	51	C272-0750-PH	90 DEGREE LONG TURN STREET ELBOW FXF COPPER FITTING	50	C460-0093-PH	REDUCER TEE CXC COPPER FITTING	54
C165-0058-PH	REDUCED COUPLER COPPER FITTING	52	C272-0850-PH	90 DEGREE LONG TURN STREET ELBOW FXF COPPER FITTING	50	C460-0094-PH	REDUCER TEE CXC COPPER FITTING	54

INDEX BY CODE

CODE	DESCRIPTION	PAGE	CODE	DESCRIPTION	PAGE	CODE	DESCRIPTION	PAGE
C460-0095-PH	REDUCER TEE CXC COPPER FITTING	54	CA-1200-W	CANTILEVER ARM - WEBBED 1200MM	30	CG-M	CONDENSING GUARD M	26
C460-0098-PH	REDUCER TEE CXC COPPER FITTING	54	CA-150-S	CANTILEVER ARM - SINGLE 150MM	30	CG-S	CONDENSING GUARD S	26
C460-0100-PH	EQUAL TEE CXCXC COPPER FITTING	53	CA-300-S	CANTILEVER ARM - SINGLE 300MM	30	CG-VRF-BP	CONDENSING GUARD BP-S	26, 103
C460-0106-PH	REDUCER TEE CXC COPPER FITTING	54	CA-450-KIT	CANTILEVER ARM KIT - 450MM	30	CG-VRF-EP-12	CONDENSING GUARD EP-M	26
C460-0107-PH	REDUCER TEE CXC COPPER FITTING	54	CA-450-S	CANTILEVER ARM - SINGLE 450MM	30	CG-VRF-EP-6	CONDENSING GUARD EP-S	26
C460-0108-PH	REDUCER TEE CXC COPPER FITTING	54	CA-600-D	CANTILEVER ARM - DOUBLE 600MM	30	CG-XL	CONDENSING GUARD XL	26
C460-0109-PH	REDUCER TEE CXC COPPER FITTING	54	CA-600-KIT	CANTILEVER ARM KIT - 600MM	30	CH-L	LARGE PROTECTIVE HOUSING	10
C460-0111-PH	REDUCER TEE CXC COPPER FITTING	54	CA-600-S	CANTILEVER ARM - SINGLE 600MM	30	CH-S	SMALL PROTECTIVE HOUSING	10
C460-0117-PH	REDUCER TEE CXC COPPER FITTING	54	CA-600-W	CANTILEVER ARM - WEBBED 600MM	30	CLL-1	PRO TITE SQUEEZE TUBE - 39ML	69
C460-0118-PH	REDUCER TEE CXC COPPER FITTING	54	CA-750-D	CANTILEVER ARM - DOUBLE 750MM	30	CMB-1000	MOUNTING BLOCKS - 1000MM	39
C460-0119-PH	REDUCER TEE CXC COPPER FITTING	54	CA-750-HKIT	CANTILEVER ARM KIT - 750MM	30	CMB-1000-W	MOUNTING BLOCKS - 1000MM	39
C460-0127-PH	REDUCER TEE CXC COPPER FITTING	54	CA-750-S	CANTILEVER ARM - SINGLE 750MM	30	CMB-350	MOUNTING BLOCKS - 350MM	39
C460-0150-PH	EQUAL TEE CXCXC COPPER FITTING	53	CA-750-W	CANTILEVER ARM - WEBBED 750MM	30	CMB-450	MOUNTING BLOCKS - 450MM	39
C460-0157-PH	REDUCER TEE CXC COPPER FITTING	54	CA-900-D	CANTILEVER ARM - DOUBLE 900MM	30	CMB-450-W	MOUNTING BLOCKS - 450MM	39
C460-0158-PH	REDUCER TEE CXC COPPER FITTING	54	CA-900-KIT	CANTILEVER ARM KIT - 900MM	30	CO-1	PULL A SPOUT OILER - 40Z (118ML)	68
C460-0159-PH	REDUCER TEE CXC COPPER FITTING	54	CA-900-S	CANTILEVER ARM - SINGLE 900MM	30	COOLWELD-32	COOL-WELD HEAT BARRIER SPRAY	68, 91
C460-0160-PH	REDUCER TEE CXC COPPER FITTING	54	CA-950-W	CANTILEVER ARM - WEBBED 950MM	30	CSL200	AC SHUT OFF SWITCH	25
C460-0161-PH	REDUCER TEE CXC COPPER FITTING	54	CB-2	DRAIN DAWG™ KIT	25	CTC-050	CABLE TIE CLIPS - 50	47
C460-0169-PH	REDUCER TEE CXC COPPER FITTING	54	CBE-140	ECONOMY BRACKET WITH CROSSBAR	28, 112	CTC-065	CABLE TIE CLIPS - 65	47
C460-0170-PH	REDUCER TEE CXC COPPER FITTING	54	CBRT-L	TYPE 1 BRACKET - LARGE	27	CTC-080	CABLE TIE CLIPS - 80	47
C460-0171-PH	REDUCER TEE CXC COPPER FITTING	54	CBRT-M	TYPE 1 BRACKET - MEDIUM	27	CTM-1	CABLE TIE MOUNT - SCREW FIXING	133
C460-0180-PH	REDUCER TEE CXC COPPER FITTING	54	CBRT-S	TYPE 1 BRACKET - SMALL	27	CTM-2	CABLE TIE MOUNT - WITH STUDDING	133
C460-0181-PH	REDUCER TEE CXC COPPER FITTING	54	CBRT-XL	TYPE 1 BRACKET - EXTRA LARGE	27	CV-14-3	NON-RETURN CHECK VALVE - 1/4" VCMA/VCC	23
C460-0215-PH	EQUAL TEE CXCXC COPPER FITTING	53	CBRT-XXL	TYPE 1 BRACKET - 2 X EXTRA LARGE	27	CV-38-3	NON-RETURN CHECK VALVE VCMA/VCC	23
C460-0220-PH	REDUCER TEE CXC COPPER FITTING	54	CBR2-EL	ECONOMY BRACKET WITH CROSSBAR	28, 112	DCP-30A	DAIRY CABINET PUMP	6
C460-0221-PH	REDUCER TEE CXC COPPER FITTING	54	CBR2-L	TYPE 2 BRACKET - LARGE	28, 96	DCP-30E	DAIRY CABINET PUMP (NO S/S OR L/D)	6
C460-0222-PH	REDUCER TEE CXC COPPER FITTING	54	CBR2-L-SS	CONDENSER MOUNTING BRACKET	30	DCP-30V	DAIRY CABINET PUMP (VERTICAL)	6
C460-0223-PH	REDUCER TEE CXC COPPER FITTING	54	CBR2-M	TYPE 2 BRACKET - MEDIUM	28, 96	DCP-P	HIGH-PRESSURE REPLACEMENT PUMP	6
C460-0224-PH	REDUCER TEE CXC COPPER FITTING	54	CBR2-M-SS	CONDENSER MOUNTING BRACKET	30	DCV-1G	VALVE FOR DLT LINE TAPS	74
C460-0234-PH	REDUCER TEE CXC COPPER FITTING	54	CBR2-S	TYPE 2 BRACKET - SMALL	28, 96	DE-05-FD	MINI PUMP WITH TRUNKING	21
C460-0235-PH	REDUCER TEE CXC COPPER FITTING	54	CBR2-XL	TYPE 2 BRACKET - XL	28, 96	DE1-10D	FLARE & MPT ELBOW BRASS FITTING	48
C460-0237-PH	REDUCER TEE CXC COPPER FITTING	54	CBR2-XL-3A	TYPE 2 BRACKET - XL (3 ARMS)	28	DE1-12D	FLARE & MPT ELBOW BRASS FITTING	48
C460-0245-PH	REDUCER TEE CXC COPPER FITTING	54	CBR2-XL-3A-BL	TYPE 2 BRACKET - XL (3 ARMS)	28, 96	DE1-12E	FLARE AND MPT ELBOW BRASS FITTING	48
C460-0246-PH	REDUCER TEE CXC COPPER FITTING	54	CBR2-XL-BL	TYPE 2 BRACKET - XL	28, 96	DE1-4B	FLARE AND MPT ELBOW BRASS FITTING	48
C460-0247-PH	REDUCER TEE CXC COPPER FITTING	54	CBR2-XL-SS	CONDENSER MOUNTING BRACKET	30	DE1-6B	FLARE & MPT ELBOW BRASS FITTING	48
C460-0295-PH	EQUAL TEE CXCXC COPPER FITTING	53	CBR2-XXL	TYPE 2 BRACKET - DOUBLE XL	28, 96	DE1-6C	FLARE AND MPT ELBOW BRASS FITTING	48
C460-0302-PH	REDUCER TEE CXC COPPER FITTING	54	CBR2-XXL-3A	TYPE 2 BRACKET - DOUBLE XL (3 ARMS)	28	DE1-6D	FLARE & MPT ELBOW BRASS FITTING	48
C460-0303-PH	REDUCER TEE CXC COPPER FITTING	54	CBR2-XXL-3A-BL	TYPE 2 BRACKET - DOUBLE XL (3 ARMS)	28, 96	DE1-8D	FLARE AND MPT ELBOW BRASS FITTING	48
C460-0304-PH	REDUCER TEE CXC COPPER FITTING	54	CBR2-XXL-3A-BL-D	TYPE 2 BRACKET - DOUBLE XL (3 ARMS)	96	DE1-8E	FLARE & MPT ELBOW BRASS FITTING	48
C460-0305-PH	REDUCER TEE CXC COPPER FITTING	54	CBR2-XXL-6L	TYPE 2 BRACKET - DOUBLE XL	28	DLT-3G	LINE TAP VALVE - 6.75MM OD TUBE	74
C460-0306-PH	REDUCER TEE CXC COPPER FITTING	54	CBR3-L	TYPE 3 BRACKET - LARGE	29	DLT-4G	LINE TAP VALVE - 6.35MM OD TUBE	74
C460-0315-PH	REDUCER TEE CXC COPPER FITTING	54	CBR3-M	TYPE 3 BRACKET - MEDIUM	29	DLT-5G	LINE TAP VALVE - 9MM OD TUBE	74
C460-0316-PH	REDUCER TEE CXC COPPER FITTING	54	CC-004	CUSHION CLAMP 1/4	43	DNI-10	SHORT MACHINE FLARE NUT BRASS FITTING	48
C460-0328-PH	REDUCER TEE CXC COPPER FITTING	54	CC-006	CUSHION CLAMP 3/8	43	DNI-12	SHORT MACHINE FLARE NUT BRASS FITTING	48
C460-0330-PH	REDUCER TEE CXC COPPER FITTING	54	CC-008	CUSHION CLAMP 1/2	43	DNI-14	SHORT MACHINE FLARE NUT BRASS FITTING	48
C460-0331-PH	REDUCER TEE CXC COPPER FITTING	54	CC-010	CUSHION CLAMP 5/8	43	DNI-3	SHORT MACHINE FLARE NUT BRASS FITTING	48
C460-0339-PH	REDUCER TEE CXC COPPER FITTING	54	CC-012	CUSHION CLAMP 3/4	43	DNI-4	SHORT MACHINE FLARE NUT BRASS FITTING	48
C460-0390-PH	EQUAL TEE CXCXC COPPER FITTING	53	CC-014	CUSHION CLAMP 7/8	43	DNI-5	SHORT MACHINE FLARE NUT BRASS FITTING	48
C460-0397-PH	REDUCER TEE CXC COPPER FITTING	54	CC-018	CUSHION CLAMP 1-1/8	43	DNI-6	SHORT MACHINE FLARE NUT BRASS FITTING	48
C460-0398-PH	REDUCER TEE CXC COPPER FITTING	54	CC-022	CUSHION CLAMP 1-3/8	43	DNI-8	SHORT MACHINE FLARE NUT BRASS FITTING	48
C460-0399-PH	REDUCER TEE CXC COPPER FITTING	54	CC-026	CUSHION CLAMP 1-5/8	43	DNI-5-4	CAP BRASS FITTING	48
C460-0400-PH	REDUCER TEE CXC COPPER FITTING	54	CC-034	CUSHION CLAMP 2-1/8	43	DNI-6-4	CAP BRASS FITTING	48
C460-0401-PH	REDUCER TEE CXC COPPER FITTING	54	CC-042	CUSHION CLAMP 2-5/8	43	DNS4-10	SHORT FORGED FLARE NUT BRASS FITTING	48
C460-0414-PH	REDUCER TEE CXC COPPER FITTING	54	CC-050	CUSHION CLAMP 3-1/8	43	DNS4-12	SHORT FORGED FLARE NUT BRASS FITTING	48
C460-0416-PH	REDUCER TEE CXC COPPER FITTING	54	CC-058	CUSHION CLAMP 3-5/8	43	DNS4-14	SHORT FORGED FLARE NUT BRASS FITTING	48
C460-0417-PH	REDUCER TEE CXC COPPER FITTING	54	CC-066	CUSHION CLAMP 4-1/8	43	DNS4-4	SHORT FORGED FLARE NUT BRASS FITTING	48
C460-0429-PH	REDUCER TEE CXC COPPER FITTING	54	CC-1	CONDENSATE COPP™ DRAIN PAN SWITCH	25	DNS4-6	SHORT FORGED FLARE NUT BRASS FITTING	48
C460-0431-PH	REDUCER TEE CXC COPPER FITTING	54	CCT-790	LIGHTWEIGHT TRAY - SMALL	31	DNS4-8	SHORT FORGED FLARE NUT BRASS FITTING	48
C460-0432-PH	REDUCER TEE CXC COPPER FITTING	54	CCT-940	LIGHTWEIGHT TRAY - LARGE	31	DP-1	NITROGEN PURGE TOOL	59
C460-0520-PH	EQUAL TEE CXCXC COPPER FITTING	53	CCTM-1080	METAL TRAY - 1080MM	31, 97	DP2-10	PLUG BRASS FITTING	48
C460-0531-PH	REDUCER TEE CXC COPPER FITTING	54	CCTM-1100	METAL TRAY - MEDIUM	31, 97	DP2-4	PLUG BRASS FITTING	48
C460-0532-PH	REDUCER TEE CXC COPPER FITTING	54	CCTM-1300	METAL TRAY - 1300MM	31, 97	DP2-6	PLUG BRASS FITTING	48
C460-0533-PH	REDUCER TEE CXC COPPER FITTING	54	CCTM-1400	METAL TRAY - LARGE	31, 97	DP2-8	PLUG BRASS FITTING	48
C460-0534-PH	REDUCER TEE CXC COPPER FITTING	54	CCTM-1420-BL	METAL TRAY	31	DT2-10	FLARE TEE BRASS FITTING	48
C460-0535-PH	REDUCER TEE CXC COPPER FITTING	54	CCTM-800	METAL TRAY - SMALL	31, 97	DT2-4	FLARE TEE BRASS FITTING	48
C460-0549-PH	REDUCER TEE CXC COPPER FITTING	54	CCTM-FLOOR-BRKT-KIT	STAINLESS STEEL BRACKETS WITH FIXINGS	31, 99	DT2-6	FLARE TEE BRASS FITTING	48
C460-0650-PH	EQUAL TEE CXCXC COPPER FITTING	53	CCTM-FLOOR-BRKT-KIT-3	STAINLESS STEEL BRACKETS WITH FIXINGS	31	DT2-8	FLARE TEE BRASS FITTING	48
C460-0663-PH	REDUCER TEE CXC COPPER FITTING	54	CCTM-FLOOR-BRKT-KIT-3	STAINLESS FLOOR BRACKET KIT FOR DRIP TRAYS	99	DUI-10D	FLARE UNION X MPT BRASS FITTING	49
C460-0664-PH	REDUCER TEE CXC COPPER FITTING	54	CCTM01420-BL	METAL TRAY	97	DUI-10E	FLARE UNION X MPT BRASS FITTING	49
C460-0750-PH	EQUAL TEE CXCXC COPPER FITTING	53	CCTM01420/BL	STAINLESS STEEL BRACKETS	31	DUI-12D	FLARE UNION X MPT BRASS FITTING	49
C460-0850-PH	EQUAL TEE CXCXC COPPER FITTING	53	CG-500-L	CONDENSING GUARD L	26	DUI-12E	FLARE UNION X MPT BRASS FITTING	49
C460-1498-PH	REDUCER TEE CXC COPPER FITTING	54	CG-500-M	CONDENSING GUARD M	26	DUI-4A	FLARE UNION X MPT BRASS FITTING	49
C533-0050-PH	P TRAP COPPER FITTING	52	CG-500-S	CONDENSING GUARD S	26	DUI-4B	FLARE UNION X MPT BRASS FITTING	49
C533-0090-PH	P TRAP COPPER FITTING	52	CG-750-INV	CONDENSING GUARD INV	26, 103	DUI-6B	FLARE UNION X MPT BRASS FITTING	49
C533-0100-PH	P TRAP COPPER FITTING	52	CG-750-L	CONDENSING GUARD L	26, 103	DUI-6C	FLARE UNION X MPT BRASS FITTING	49
C533-0150-PH	P TRAP COPPER FITTING	52	CG-750-M	CONDENSING GUARD M	26, 103	DUI-6D	FLARE UNION X MPT BRASS FITTING	49
C533-0215-PH	P TRAP COPPER FITTING	52	CG-750-S	CONDENSING GUARD S	26, 103	DUI-6E	FLARE UNION X MPT BRASS FITTING	49
C533-0295-PH	P TRAP COPPER FITTING	52	CG-750L-WOOD	WOODEN CONDENSING GUARD L	26, 103	DUI-6B	FLARE UNION X MPT BRASS FITTING	49
C533-0390-PH	P TRAP COPPER FITTING	52	CG-750L+INVWOOD	WOODEN CONDENSING GUARD L+INV	26, 103	DUI-8C	FLARE UNION X MPT BRASS FITTING	49
C947-0025-PH	U-TYPE STRAP COPPER FITTING	53	CG-750L+WOOD	WOODEN CONDENSING GUARD L+	26, 103	DUI-8D	FLARE UNION X MPT BRASS FITTING	49
C947-0050-PH	U-TYPE STRAP COPPER FITTING	53	CG-750LINV+WOOD	WOODEN CONDENSING GUARD L+INV	26, 103	DUI-8E	FLARE UNION X MPT BRASS FITTING	49
C947-0090-PH	U-TYPE STRAP COPPER FITTING	53	CG-750M-WOOD	WOODEN CONDENSING GUARD M	26, 103	DU2-10	FLARE UNION BRASS FITTING	48
C947-0100-PH	U-TYPE STRAP COPPER FITTING	53	CG-750M+WOOD	WOODEN CONDENSING GUARD M+	26, 103	DU2-12	FLARE UNION BRASS FITTING	48
C947-0150-PH	U-TYPE STRAP COPPER FITTING	53	CG-750S-WOOD	WOODEN CONDENSING GUARD S	26, 103	DU2-4	FLARE UNION BRASS FITTING	48
C947-0215-PH	U-TYPE STRAP COPPER FITTING	53	CG-900-XXL	CONDENSING GUARD XXL	26, 103	DU2-6	FLARE UNION BRASS FITTING	48
C947-0295-PH	U-TYPE STRAP COPPER FITTING	53	CG-900L-INV	CONDENSING GUARD L+INV	26, 103	DU2-8	FLARE UNION BRASS FITTING	48
C947-0390-PH	U-TYPE STRAP COPPER FITTING	53	CG-900L-SQ	CONDENSING GUARD L+SQ	26, 103	DU3-10D	FLARE X FPT UNION BRASS FITTING	49
CA-1200-D	CANTILEVER ARM - DOUBLE 1200MM	30	CG-L	CONDENSING GUARD L	26	DU3-10E	FLARE X FPT UNION BRASS FITTING	49

CODE	DESCRIPTION	PAGE	CODE	DESCRIPTION	PAGE	CODE	DESCRIPTION	PAGE
DU3-6C	FLARE X FPT UNION BRASS FITTING	49	FF-600-S-KIT-3	FLEXI-FOOT KIT - 600	98	HIL-CM35-7/8-11/8	HILMOR A FRAME BENDER FORMERS AND GUIDES	220
DU3-6D	FLARE X FPT UNION BRASS FITTING	49	FF-FIX-2	FLEXI FIX PACK TO SECURE A OUTDOOR UNIT	111	HIL-CM35-7/8DISC	HILMOR 7/8" FORMER DISC	220
DU3-8C	FLARE X FPT UNION BRASS FITTING	49	FF-FIX-PACK	FLEXI FIX PACK TO SECURE A OUTDOOR UNIT	111	HIL-CM35-7/8GUIDE	HILMOR 7/8" GUIDE	220
DU3-8D	FLARE X FPT UNION BRASS FITTING	49	FF-FIXCLAMP	FLEXI FOOT FIX CLAMP	98, 111	HIL-CM35-1/8 TO 1/8	HILMOR CM35 FRAME FORMER AND GUIDES	220
DUS4-4	FLARE X FLARE SWIVEL UNION BRASS FITTING	49	FF-UC3	FLEXI-LITE SLAB KIT	38, 97	HIL-GLM-15-22	HILMOR HIL-GLM-15-22 HAND TUBE BENDERS	221
DUS4-6	FLARE X FLARE SWIVEL UNION BRASS FITTING	49	FF-UC3-3	FLEXI LITE SLAB KIT - 3 FEET	38, 97	HILMOR TOOLS	HILMOR TOOLS	215
DUS4-8	FLARE X FLARE SWIVEL UNION BRASS FITTING	49	FF-UC3-3XL	FLEXI-LITE SLAB KIT - 3 FEET - EXTRA LARGE	38, 97	HTOOLS	HTOOLS	179
DX-3	UNIVERSAL COPPER SPUN DRIER	59	FF-UC3-3XL-150	FLEXI-LITE SLAB KIT - 3 FEET	38, 97	IC00-15	RPC INSULCLIPS 5/8	46
DX-4	UNIVERSAL COPPER SPUN DRIER	59	FF-UC3-M	FLEXI LITE KIT - MEDIUM	38, 97	IC00-20	RPC INSULCLIPS 3/4	46
DXA-5	UNIVERSAL COPPER SPUN DRIER	59	FF-UC3-S	FLEXI LITE KIT - SMALL	38, 97	IC00-22	RPC INSULCLIPS 7/8	46
EC-1	1 LITRE TANK PUMP	21	FF-UC3-XL	FLEXI-LITE SLAB KIT - EXTRA LARGE	38, 97	IC00-25	RPC INSULCLIPS 1	46
EC-1KIT	MINI PUMP WITH TRUNKING	21	FG-154	FAN GUARD 154MM	9	IC00-28	RPC INSULCLIPS 1-1/4	46
ECOP-ADAP	CONDENSATE DRAIN ADAPTOR	23	FG-172	FAN GUARD 172MM	9	IC00-32	RPC INSULCLIPS 1/8	46
EZB	EASYBEND LINE SET BENDER	202	FG-200	FAN GUARD 172MM	9	IC00-35	RPC INSULCLIPS 1-3/8	46
F-HF-305	FLEXI H-FRAME KIT	109	FG-230	FAN GUARD 172MM	9	IC00-40	RPC INSULCLIPS 1-1/2	46
F-HF-320	FLEXI H-FRAME KIT	109	FG-254	FAN GUARD 200MM	9	IC00-42	RPC INSULCLIPS 1-5/8	46
F-HF-500	FLEXI H-FRAME KIT	109	FG-300	FAN GUARD 200MM	9	IC00-50	RPC INSULCLIPS 2	46
F-HO-1000	FLEXI HOP OVER - 1000MM	117	FH-300-28-1/4ELB	FLEXIBLE ASHP HOSE PAIR	101	IC00-54	RPC INSULCLIPS 2-1/8	46
F-HO-600	FLEXI HOP OVER - 600MM	117	FH-300-28-F-ELBOW	FLEXIBLE ASHP HOSE PAIR	101	IC00-54	RPC INSULCLIPS 2-1/8	46
F-HO-HR	FLEXI HAND RAIL FOR HOP OVER	117	FH-500-22-F	FLEXIBLE ASHP HOSE PAIR	101	ID-BT-250	BIGTIE - 250MM	36, 133
F-MF-110	FLEXI FOOT MINI - 110MM	112	FH-500-28-F	FLEXIBLE ASHP HOSE PAIR	101	ID-BT-350	BIGTIE - 350MM	36, 133
F-MF-160	FLEXI FOOT MINI - 160MM	112	FH-750-28-1/4F	FLEXIBLE ASHP HOSE PAIR	101	ID-DH-14	DRAIN HOSE - IVORY 14MM (20MM BOX)	35
F-QUAD-320-A	FLEXI QUAD (ADJUSTABLE LEGS)	114	FH-750-28-1/4M	FLEXIBLE ASHP HOSE PAIR	101	ID-DH-16	DRAIN HOSE - IVORY 16MM (20MM BOX)	35
F-QUAD-500-A	FLEXI QUAD (ADJUSTABLE LEGS)	114	FH-750-28-F	FLEXIBLE ASHP HOSE PAIR	101	ID-NSD-100-I	SLIMDUCT - 100MM - 2000MM - IVORY	32
F-SO-2	FLEXI STEP OVER 2 UP / 2 DOWN	117	FH-750-28-F-ELBOW	FLEXIBLE ASHP HOSE PAIR	101	ID-NSD-100-W	SLIMDUCT - 100MM - 2000MM - WHITE	32
F-SO-3	FLEXI STEP OVER 3 UP / 3 DOWN	117	FH-750-28-M	FLEXIBLE ASHP HOSE PAIR	101	ID-NSD-75-I	SLIMDUCT - 75MM - 2000MM - IVORY	32
F-SO-4	FLEXI STEP OVER 4 UP / 4 DOWN	117	FH-750-28-M	FLEXIBLE ASHP HOSE PAIR	101	ID-NSD-75-W	SLIMDUCT - 75MM - 2000MM - WHITE	32
F-TQ-ADU-D	DOUBLE MOUNTING PLATE	113, 114, 115	FH-I-1000-15	PVC COATED WEATHER & WATERPROOF INSULATION	101	ID-SC-100-I	SLIMDUCT - 100MM ELBOW BEND - IVORY	32
F-TQ-ADU-S	SINGLE MOUNTING PLATE	113, 114	FH-I-1000-22	PVC COATED WEATHER & WATERPROOF INSULATION	101	ID-SC-100-K	SLIMDUCT - 100MM ELBOW BEND - BLACK	32
F-TWIN-320-A	FLEXI TWIN (ADJUSTABLE LEGS)	113	FH-I-1000-22-SLIT	PRE SLIT AND SEAL INSULATION	102	ID-SC-100-W	SLIMDUCT - 100MM ELBOW BEND - WHITE	32
F-TWIN-500-A	FLEXI TWIN (ADJUSTABLE LEGS)	113	FH-I-1000-28	PVC COATED WEATHER & WATERPROOF INSULATION	101	ID-SC-75-B	SLIMDUCT - 75MM ELBOW BEND - BROWN	32
F102	SPIN 1/2"	181	FH-I-1000-28-F	PVC COATED WEATHER & WATERPROOF INSULATION	101	ID-SC-75-I	SLIMDUCT - 75MM ELBOW BEND - IVORY	32
F104	SPIN 1/4"	181	FH-I-1000-28-SLIT	PRE SLIT AND SEAL INSULATION	102	ID-SC-75-K	SLIMDUCT - 75MM ELBOW BEND - BLACK	32
F1034	SPIN 3/4"	181	FH-I-1000-35	PVC COATED WEATHER & WATERPROOF INSULATION	101	ID-SC-75-W	SLIMDUCT - 75MM ELBOW BEND - WHITE	32
F1038	SPIN 3/8"	181	FH-I-1000-35-SLIT	PRE SLIT AND SEAL INSULATION	102	ID-SCF-100-B	SLIMDUCT - 100MM 45 DEG ELBOW BEND - BROWN	32
F1058	SPIN 5/8"	181	FHXIS	FLEXI SUPPORT SYSTEMS	119	ID-SCF-100-I	SLIMDUCT - 100MM 45 DEGREE ELBOW BEND - IVORY	32
F1078	SPIN 7/8"	181	FLOW-PLUS-25	FLOW PLUS CONDENSATE DRAIN PAN TABLETS	70	ID-SCF-100-K	SLIMDUCT - 100MM 45 DEGREE ELBOW BEND - BLACK	32
F1516	SPIN 5/16"	181	FLOW-PLUS-6	FLOW PLUS CONDENSATE DRAIN PAN TABLETS	70	ID-SCF-100-W	SLIMDUCT - 100MM 45 DEGREE ELBOW BEND - WHITE	32
F4000	SPIN 1/4, 3/8, 1/2, 5/8	181	FM-10W	UNIVERSAL MULTI-FIT FAN MOTOR - 10W	8	ID-SCF-75-B	SLIMDUCT - 75MM 45 DEG ELBOW BEND - BROWN	32
F5000	SPIN 1/4, 3/8, 1/2, 5/8, 3/4	181	FM-16W	UNIVERSAL MULTI-FIT FAN MOTOR - 16W	8	ID-SCF-75-I	SLIMDUCT - 75MM 45 DEGREE ELBOW BEND - IVORY	32
F6000	SPIN 1/4, 3/8, 1/2, 5/8, 3/4, 7/8	181	FM-18W	UNIVERSAL MULTI-FIT FAN MOTOR - 18W	8	ID-SCF-75-K	SLIMDUCT - 75MM 45 DEGREE ELBOW BEND - BLACK	32
FBB-154-25	FAN BLADE - BLOWER 154MM	9	FM-25W	UNIVERSAL MULTI-FIT FAN MOTOR - 25W	8	ID-SCF-75-W	SLIMDUCT - 75MM 45 DEGREE ELBOW BEND - WHITE	32
FBB-154-31	FAN BLADE - BLOWER 154MM	9	FM-5W	UNIVERSAL MULTI-FIT FAN MOTOR - 5W	8	ID-SD-100-B	SLIMDUCT - 100MM - 2000MM - BLACK	32
FBB-172-25	FAN BLADE - BLOWER 172MM	9	FM-7W	UNIVERSAL MULTI-FIT FAN MOTOR - 7W	8	ID-SD-75-B	SLIMDUCT - 75MM - 2000MM - BROWN	32
FBB-172-31	FAN BLADE - BLOWER 172MM	9	FM-A-12025-L	AXIAL FAN MOTOR - 13W (WITH LEAD)	8	ID-SD-75-K	SLIMDUCT - 75MM - 2000MM - BLACK	32
FBB-200-25	FAN BLADE - BLOWER 200MM	9	FM-A-12038-L	AXIAL FAN MOTOR - 20W (WITH LEAD)	8	ID-SDR-100-75-I	SLIMDUCT - 100-75MM REDUCER JOINT - IVORY	32
FBB-200-31	FAN BLADE - BLOWER 200MM	9	FM-A-12038-T	AXIAL FAN MOTOR - 20W (WITH TERMINAL)	8	ID-SDR-100-75-K	SLIMDUCT - 100-75MM REDUCER JOINT - BLACK	32
FBB-230-25	FAN BLADE - BLOWER 230MM	9	FM-A-8038-L	AXIAL FAN MOTOR - 15W (WITH LEAD)	8	ID-SDR-100-75-W	SLIMDUCT - 100-75MM REDUCER JOINT - WHITE	32
FBB-230-31	FAN BLADE - BLOWER 230MM	9	FMTS-20W-L-20	TANGENTIAL FAN MOTOR 20W WITH 180MM BLADE	8	ID-SE-75-B	SLIMDUCT - 75MM DUCT END - BROWN	35
FBB-254-25	FAN BLADE - BLOWER 254MM	9	FMTS-30W-240	TANGENTIAL FAN MOTOR 30W WITH 240MM BLADE	8	ID-SE-75-I	SLIMDUCT - 75MM DUCT END - IVORY	35
FBB-254-31	FAN BLADE - BLOWER 254MM	9	FMTS-30W-300	TANGENTIAL FAN MOTOR 30W WITH 300MM BLADE	8	ID-SE-75-K	SLIMDUCT - 75MM DUCT END - BLACK	35
FBB-300-25	FAN BLADE - BLOWER 300MM	9	FMTS-LSW-120	TANGENTIAL FAN MOTOR 15W WITH 120MM BLADE	8	ID-SE-75-W	SLIMDUCT - 75MM DUCT END - WHITE	35
FBB-300-31	FAN BLADE - BLOWER 300MM	9	FP-36	FLEXI PATCH FIBREGLASS REPAIR PATCH	76, 92	ID-SEN-100-B	SLIMDUCT - 100MM DUCT END - BROWN	35
FBR-109-1	FAN BLADE RING 109MM	9	FRS-154	FAN RING 154MM	9	ID-SEN-100-I	SLIMDUCT - 100MM DUCT END - IVORY	35
FBR-109-2	FAN BLADE RING 109MM	9	FRS-172	FAN RING 154MM	9	ID-SEN-100-K	SLIMDUCT - 100MM DUCT END - BLACK	35
FBR-109-3	FAN BLADE RING 109MM	9	FRS-200	FAN RING 172MM	9	ID-SEN-100-W	SLIMDUCT - 100MM DUCT END - WHITE	35
FBR-39	FAN BLADE RING 39MM	9	FRS-230	FAN RING 172MM	9	ID-SF-100-800-B	SLIMDUCT - 100MM - 800MM FLEXIBLE JOINT - BROWN	33
FBR-55	FAN BLADE RING 55MM	9	FRS-254	FAN RING 200MM	9	ID-SF-100-800-I	SLIMDUCT - 100MM - 800MM FLEXIBLE JOINT - IVORY	33
FBR-72	FAN BLADE RING 72MM	9	FRS-300	FAN RING 200MM	9	ID-SF-100-800-K	SLIMDUCT - 100MM - 800MM FLEXIBLE JOINT - BLACK	33
FBR-84	FAN BLADE RING 84MM	9	G2G-BUBBLE+GB	BUBBLE UP LEAK DETECTOR PRE-MIXED	56	ID-SF-100-800-W	SLIMDUCT - 100MM - 800MM FLEXIBLE JOINT - WHITE	33
FBS-154-25	FAN BLADE - SUCKER 154MM	9	G2G-CARE-GB	LIQUID COIL CLEANER WITH DISINFECTANT	56	ID-SF-75-500-B	SLIMDUCT - 75MM - 500MM FLEXIBLE JOINT - BROWN	33
FBS-154-31	FAN BLADE - SUCKER 154MM	9	G2G-FOAM+GB	FOAMING ALKALINE BASED PRE-MIXED COIL CLEANER	56	ID-SF-75-500-I	SLIMDUCT - 75MM - 500MM FLEXIBLE JOINT - IVORY	33
FBS-172-25	FAN BLADE - SUCKER 172MM	9	G2G-GREEN+GB	G2G GREEN 1 LITRE PRE-MIXED COIL CLEANER SPRAY	105	ID-SF-75-500-K	SLIMDUCT - 75MM - 500MM FLEXIBLE JOINT - BLACK	33
FBS-172-31	FAN BLADE - SUCKER 172MM	9	G2G-GREEN+GB	ENVIRONMENTALLY FRIENDLY PRE - MIXED COIL CLEANER	56	ID-SF-75-500-W	SLIMDUCT - 75MM - 500MM FLEXIBLE JOINT - WHITE	33
FBS-200-25	FAN BLADE - SUCKER 200MM	9	G2G-SMELL-BUSTER	SMELL BUSTER PRE-MIXED	57	ID-SIF-100-B	SLIMDUCT - 100MM OFFSET BEND - BROWN	35
FBS-200-31	FAN BLADE - SUCKER 200MM	9	G2G-UNIV-GB	PRO UNIVERSAL PRE-MIXED COIL CLEANER	56	ID-SIF-100-I	SLIMDUCT - 100MM OFFSET BEND - IVORY	35
FBS-230-25	FAN BLADE - SUCKER 230MM	9	GAUGES & HOSES	GAUGES & HOSES	209	ID-SIF-100-K	SLIMDUCT - 100MM OFFSET BEND - BLACK	35
FBS-230-31	FAN BLADE - SUCKER 230MM	9	GFC-1	GRIP FIT CLAMP - SIZE 1	43	ID-SIF-100-W	SLIMDUCT - 100MM OFFSET BEND - WHITE	35
FBS-254-25	FAN BLADE - SUCKER 254MM	9	GFC-2	GRIP FIT CLAMP - SIZE 2	43	ID-SIF-75-B	SLIMDUCT - 75MM OFFSET BEND - BROWN	35
FBS-254-31	FAN BLADE - SUCKER 254MM	9	GFC-3	GRIP FIT CLAMP - SIZE 3	43	ID-SIF-75-I	SLIMDUCT - 75MM OFFSET BEND - IVORY	35
FBS-300-25	FAN BLADE - SUCKER 300MM	9	GFC-4	GRIP FIT CLAMP - SIZE 4	43	ID-SIF-75-K	SLIMDUCT - 75MM OFFSET BEND - BLACK	35
FBS-300-31	FAN BLADE - SUCKER 300MM	9	GG-1	DRAIN GUN LINE CLEANER	58, 89	ID-SIF-75-W	SLIMDUCT - 75MM OFFSET BEND - WHITE	35
FBV-F8F-1FF	FILL & FLUSH FLOW SETTER 1" FEMALE/FEMALE	99	GG-1A	DRAIN GUN - ADAPTOR KIT	58, 89	ID-SJ-100-B	SLIMDUCT - 100MM CONNECTION PIECE - BROWN	33
FF-1000-S	FLEXI FOOT SINGLE 1000X185X100	98, 110	GG-1H	DRAIN GUN - HOSE ASSEMBLY	58, 89	ID-SJ-100-I	SLIMDUCT - 100MM CONNECTION PIECE - IVORY	33
FF-1000-S-KIT	FLEXI FOOT KIT - 1000	98	GGC-6	DRAIN GUN - PACK OF 6, CO2 CARTRIDGES	58, 89	ID-SJ-100-K	SLIMDUCT - 100MM CONNECTION PIECE - BLACK	33
FF-250-S	FLEXI FOOT SINGLE 250X185X100	98, 110	HIL-CM35-MO	HILMOR CM35 FRAME ONLY TUBE BENDERS	220	ID-SJ-100-W	SLIMDUCT - 100MM CONNECTION PIECE - WHITE	33
FF-250-S-P-L	FLEXI FOOT WITH STRUT LOW PROFILE	110	HIL-EL25-20-25	HILMOR EL25 MACHINE, VICE, FORMERS	220	ID-SJ-75-B	SLIMDUCT - 75MM CONNECTION PIECE - BROWN	33
FF-250-S-UNI	FLEXI FOOT UNIVERSAL - 250MM	111	HIL-EL25-MO	HILMOR EL25 MACHINE AND VICE TUBE BENDERS	220	ID-SJ-75-I	SLIMDUCT - 75MM CONNECTION PIECE - IVORY	33
FF-400-S	FLEXI FOOT SINGLE 400X185X100	98, 110	HIL-CM35-1/8DISC	HILMOR 1/8" FORMER DISC	220	ID-SJ-75-K	SLIMDUCT - 75MM CONNECTION PIECE - BLACK	33
FF-400-S-KIT	FLEXI FOOT KIT - 400	98	HIL-CM35-1/8GUIDE	HILMOR 1/8" GUIDE	220	ID-SJ-75-W	SLIMDUCT - 75MM CONNECTION PIECE - WHITE	33
FF-400-S-P-L	FLEXI FOOT WITH STRU	110	HIL-CM35-15 TO 28	HILMOR CM35 FRAME FORMER AND GUIDES	220	ID-SK-100-B	SLIMDUCT - 100MM 90 DEG FLAT BEND - BROWN	33
FF-600-3-ASN-KIT	FLEXI FOOT KIT - 600 NARROW	98	HIL-CM35-15-28	HILMOR A FRAME BENDER FORMERS AND GUIDES	220	ID-SK-100-I	SLIMDUCT - 100MM 90 DEGREE FLAT BEND - IVORY	33
FF-600-S	FLEXI FOOT WITH STRUT - 600MM	110	HIL-CM35-15DISC	HILMOR 15MM FORMER DISC	220	ID-SK-100-K	SLIMDUCT - 100MM 90 DEGREE FLAT BEND - BLACK	33
FF-600-S	FLEXI FOOT SINGLE 600X185X100	98	HIL-CM35-15GUIDE	HILMOR 15MM GUIDE	220	ID-SK-100-W	SLIMDUCT - 100MM 90 DEGREE FLAT BEND - WHITE	33
FF-600-S-150	FLEXI FOOT SINGLE 600X185X150	98	HIL-CM35-22DISC	HILMOR 22MM FORMER DISC	220	ID-SK-75-B	SLIMDUCT - 75MM 90 DEG FLAT BEND - BROWN	33
FF-600-S-150-KIT	FLEXI FOOT KIT - 600 X 150 HIGH	98	HIL-CM35-22GUIDE	HILMOR 22MM GUIDE	220	ID-SK-75-I	SLIMDUCT - 75MM 90 DEGREE FLAT BEND - IVORY	33
FF-600-S-150-KIT-3	FLEXI FOOT KIT - 600 X 150 HIGH	98	HIL-CM35-28DISC	HILMOR 28MM FORMER DISC	220	ID-SK-75-K	SLIMDUCT - 75MM 90 DEGREE FLAT BEND - BLACK	33
FF-600-S-KIT	FLEXI FOOT KIT - 600	98	HIL-CM35-28GUIDE	HILMOR 28MM GUIDE	220	ID-SK-75-W	SLIMDUCT - 75MM 90 DEGREE FLAT BEND - WHITE	33

INDEX BY CODE



CODE	DESCRIPTION	PAGE	CODE	DESCRIPTION	PAGE	CODE	DESCRIPTION	PAGE
ID-SKF-100-B	SLIMDUCT - 100MM 45 DEG FLAT BEND - BROWN	33	IMP-805MRR	SINGLE HOSES 1/4" X 1/4" (RED)	206	K12-58	K-KLAMP PIPE AND INSULATION CLAMP - 5/8"	7, 44, 131
ID-SKF-100-I	SLIMDUCT - 100MM 45 DEGREE FLAT BEND - IVORY	33	IMP-805MRS	STANDARD HOSE SET 1/4" X 1/4" (RED, YELLOW, BLUE)	206	K12-78	K-KLAMP PIPE AND INSULATION CLAMP - 7/8"	7, 44, 131
ID-SKF-100-K	SLIMDUCT - 100MM 45 DEGREE FLAT BEND - BLACK	33	IMP-806MRR	SINGLE HOSES 1/4" X 1/4" (BLUE)	206	K34-118	K-KLAMP PIPE AND INSULATION CLAMP - 1-1/8"	7, 44, 131
ID-SKF-100-W	SLIMDUCT - 100MM 45 DEGREE FLAT BEND - WHITE	33	IMP-806MRR	SINGLE HOSES 1/4" X 1/4" (RED)	206	K34-12	K-KLAMP PIPE AND INSULATION CLAMP - 1/2"	7, 44, 131
ID-SKF-75-B	SLIMDUCT - 75MM 45 DEG FLAT BEND - BROWN	33	IMP-806MRS	STANDARD HOSE SET 1/4" X 1/4" (RED, YELLOW, BLUE)	206	K34-138	K-KLAMP PIPE AND INSULATION CLAMP - 1-3/8"	7, 44, 131
ID-SKF-75-I	SLIMDUCT - 75MM 45 DEGREE FLAT BEND - IVORY	33	IMP-806MRY	SINGLE HOSES 1/4" X 1/4" (YELLOW)	206	K34-14	K-KLAMP PIPE AND INSULATION CLAMP - 1/4"	7, 44, 131
ID-SKF-75-K	SLIMDUCT - 75MM 45 DEGREE FLAT BEND - BLACK	33	IMP-840C-36-PH	MANIFOLD NO SIGHT GLASS, 80MM GAUGES	205	K34-158	K-KLAMP PIPE AND INSULATION CLAMP - 1-5-8"	7, 44, 131
ID-SKF-75-W	SLIMDUCT - 75MM 45 DEGREE FLAT BEND - WHITE	33	IMP-840C-60-PH	MANIFOLD NO SIGHT GLASS, 80MM GAUGES	205	K34-218	K-KLAMP PIPE AND INSULATION CLAMP - 2-1/8"	7, 44, 131
ID-SL-300	SLIMDUCT - TIE CLIP	36	IMP-840C-72-PH	MANIFOLD NO SIGHT GLASS, 80MM GAUGES	205	K34-258	K-KLAMP PIPE AND INSULATION CLAMP - 2-5/8"	7, 44, 131
ID-SP-100-B	SLIMDUCT - 100MM FLAT ROSETTE BROWN	36	IMP-840C-PH	MANIFOLD NO SIGHT GLASS, 80MM GAUGES	205	K34-318	K-KLAMP PIPE AND INSULATION CLAMP - 3-1/8"	7, 44, 131
ID-SP-100-I	SLIMDUCT - 100MM FLAT ROSETTE IVORY	36	IMP-848C-36-PH	MANIFOLD NO SIGHT GLASS, 80MM GAUGES	205	K34-34	K-KLAMP PIPE AND INSULATION CLAMP - 3/4"	7, 44, 131
ID-SP-100-K	SLIMDUCT - 100MM FLAT ROSETTE BLACK	36	IMP-848C-60-PH	MANIFOLD NO SIGHT GLASS, 80MM GAUGES	205	K34-358	K-KLAMP PIPE AND INSULATION CLAMP - 3-5/8"	7, 44, 131
ID-SP-100-W	SLIMDUCT - 100MM FLAT ROSETTE WHITE	36	IMP-848C-72-PH	MANIFOLD NO SIGHT GLASS, 80MM GAUGES	205	K34-38	K-KLAMP PIPE AND INSULATION CLAMP - 3/8"	7, 44, 131
ID-SP-75-B	SLIMDUCT - 75MM FLAT ROSETTE BROWN	36	IMP-849C-36-PH	MANIFOLD NO SIGHT GLASS, 80MM GAUGES	205	K34-418	K-KLAMP PIPE AND INSULATION CLAMP - 4-1/8"	7, 44, 131
ID-SP-75-I	SLIMDUCT - 75MM FLAT ROSETTE IVORY	36	IMP-849C-60-PH	MANIFOLD NO SIGHT GLASS, 80MM GAUGES	205	K34-58	K-KLAMP PIPE AND INSULATION CLAMP - 5/8"	7, 44, 131
ID-SP-75-K	SLIMDUCT - 75MM FLAT ROSETTE BLACK	36	IMP-849C-72-PH	MANIFOLD NO SIGHT GLASS, 80MM GAUGES	205	K34-78	K-KLAMP PIPE AND INSULATION CLAMP - 7/8"	7, 44, 131
ID-SP-75-W	SLIMDUCT - 75MM FLAT ROSETTE WHITE	36	IMP-853MRB	SINGLE HOSES 1/4" X 5/16" (BLUE) R410A/R32	206	K38-100	K-KLAMP PIPE AND INSULATION CLAMP - 1"	7, 44, 131
ID-ST-100-B	SLIMDUCT - 100MM T-JOINT - BROWN	34	IMP-853MRR	SINGLE HOSES 1/4" X 5/16" (RED) R410A/R32	206	K38-118	K-KLAMP PIPE AND INSULATION CLAMP - 1-1/8"	7, 44, 131
ID-ST-100-I	SLIMDUCT - 100MM T-JOINT - IVORY	34	IMP-853MRS	STANDARD HOSE SET (RED, YELLOW, BLUE)	206	K38-12	K-KLAMP PIPE AND INSULATION CLAMP - 1/2"	7, 44, 131
ID-ST-100-K	SLIMDUCT - 100MM T-JOINT - BLACK	34	IMP-853MRY	SINGLE HOSES 1/4" X 5/16" (YELLOW)	206	K38-138	K-KLAMP PIPE AND INSULATION CLAMP - 1-3/8"	7, 44, 131
ID-ST-100-W	SLIMDUCT - 100MM T-JOINT - WHITE	34	IMP-855MRR	SINGLE HOSES 1/4" X 5/16" (RED)	206	K38-14	K-KLAMP PIPE AND INSULATION CLAMP - 1/4"	7, 44, 131
ID-ST-75-B	SLIMDUCT - 75MM T-JOINT - BROWN	34	IMP-855MRS	SINGLE HOSES 1/4" X 5/16" (BLUE)	206	K38-158	K-KLAMP PIPE AND INSULATION CLAMP - 1-5/8"	7, 44, 131
ID-ST-75-I	SLIMDUCT - 75MM T-JOINT - IVORY	34	IMP-855MRS	STANDARD HOSE SET (RED, YELLOW, BLUE)	206	K38-218	K-KLAMP PIPE AND INSULATION CLAMP - 2-1/8"	7, 44, 131
ID-ST-75-K	SLIMDUCT - 75MM T-JOINT - BLACK	34	IMP-855MRY	SINGLE HOSES 1/4" X 5/16" (YELLOW)	206	K38-34	K-KLAMP PIPE AND INSULATION CLAMP - 3/4"	7, 44, 131
ID-ST-75-W	SLIMDUCT - 75MM T-JOINT - WHITE	34	IMP-866MRB	SINGLE HOSES 1/4" X 5/16" (BLUE)	206	K38-38	K-KLAMP PIPE AND INSULATION CLAMP - 3/8"	7, 44, 131
ID-SW-100-B	SLIMDUCT - 100MM WALL COVER - BROWN	34	IMP-866MRR	SINGLE HOSES 1/4" X 5/16" (RED)	206	K38-58	K-KLAMP PIPE AND INSULATION CLAMP - 5/8"	7, 44, 131
ID-SW-100-I	SLIMDUCT - 100MM WALL COVER - IVORY	34	IMP-866MRS	STANDARD HOSE SET (RED, YELLOW, BLUE)	206	K38-78	K-KLAMP PIPE AND INSULATION CLAMP - 7/8"	7, 44, 131
ID-SW-100-K	SLIMDUCT - 100MM WALL COVER - BLACK	34	IMP-866MRY	SINGLE HOSES 1/4" X 5/16" (YELLOW)	206	KT-1028	UNIVERSAL REMOTE CONTROLLER	42
ID-SW-100-W	SLIMDUCT - 100MM WALL COVER - WHITE	34	IMP-87958302	HOSE GASKETS FOR 3/8" HOSE	206	LEAK DETECTION	LEAK DETECTION	155
ID-SW-75-B	SLIMDUCT - 75MM WALL COVER - BROWN	34	IMP-87958302	HOSE GASKETS FOR 5/16" HOSE	206	M-1	MIRROR 1-1/4" CIRCULAR	59, 91
ID-SW-75-I	SLIMDUCT - 75MM WALL COVER - IVORY	34	IMP-16C	STRAIGHT COUPLER (45° FLARE)	206	M-1R	REPLACEMENT HEAD FOR M-1	59
ID-SW-75-K	SLIMDUCT - 75MM WALL COVER - BLACK	34	IMP-28C	SET INCLUDES IMP-28C AND IMP-27C	206	M-2	MIRROR 2-1/4" CIRCULAR	59, 91
ID-SW-75-W	SLIMDUCT - 75MM WALL COVER - WHITE	34	IMP-848C-PH	MANIFOLD NO SIGHT GLASS, 80MM GAUGES	205	M-2R	REPLACEMENT HEAD FOR M-2	59
ID-SWC-100-B	SLIMDUCT - 100MM WALL ROSETTE - BROWN	34	IMP-849C-PH	MANIFOLD NO SIGHT GLASS, 80MM GAUGES	205	M-3	MIRROR 2-1/8" X 3-1/2" RECTANGULAR	59, 91
ID-SWC-100-I	SLIMDUCT - 100MM WALL ROSETTE - IVORY	34	IMP-87958301	HOSE GASKETS FOR 1/4" HOSE	206	M-3R	REPLACEMENT HEAD FOR M-3	59, 91
ID-SWC-100-K	SLIMDUCT - 100MM WALL ROSETTE - BLACK	34	IMPERIAL	IMPERIAL ACCESS VALVES & ADAPTORS	199	M-4	MIRROR 7/8" CIRCULAR - EXTENDS 6-1/2"	59
ID-SWC-100-W	SLIMDUCT - 100MM WALL ROSETTE - WHITE	34	IMPERIAL	IMPERIAL ADAPTORS	197	M-5	MIRROR 1" X 2" OVAL - EXTENDS 8-1/2"	59, 91
ID-SWC-75-B	SLIMDUCT - 75MM WALL ROSETTE BROWN	34	IMPERIAL	IMPERIAL COMBINATION TOOLS	196	MANIFOLDS	MANIFOLDS	203
ID-SWC-75-I	SLIMDUCT - 75MM WALL ROSETTE IVORY	34	IMPERIAL	IMPERIAL FLARING & SWAGING	189	MAP+	MAP+ PROPANE, PROPENE & DIMETHYL ETHER MIXTURE	58, 59
ID-SWC-75-K	SLIMDUCT - 75MM WALL ROSETTE - BLACK	34	IMPERIAL	IMPERIAL GAUGES & HOSES	209	MBK-6	DRAIN KAT™	25
ID-SWC-75-W	SLIMDUCT - 75MM WALL ROSETTE - WHITE	34	IMPERIAL	IMPERIAL KWIK COUPLER	200	MF-2	MINI FLOWWATCH 2	21
ID-VD-2100	SLIM DUCT CUTTER	35	IMPERIA	IMPERIAL OIL PUMPS & ADAPTOR KITS	185	MINIMAX	PROMAX MINIMAX COMPACT RECOVERY UNIT	150
IMP-17C	90° ELBOW COUPLER (45° FLARE)	206	IMPERIAL	IMPERIAL REFRIGERANT CHARGING & RECOVERY	201	MINIMAX-E	PROMAX MINIMAX COMPACT RECOVERY UNIT	150
IMP-18C	SET INCLUDES IMP-18C AND IMP-17C	206	IMPERIAL	IMPERIAL TESTING & SERVICE TOOLS	194	MP-12C	PAD - 305MM	40
IMP-26C	STRAIGHT COUPLER (45° FLARE)	206	IMPERIAL	IMPERIAL TOOL BAGS	195	MP-12E	PAD - 305MM	40
IMP-27C	90° ELBOW COUPLER (45° FLARE)	206	IMPERIAL	IMPERIAL TUBE BENDERS	185	MP-18	RUBBER ANTI-VIBRATION PAD - 460MM	40
IMP-406CB	SINGLE GAUGE 63MM (2-1/2")	207	IMPERIAL	IMPERIAL TUBE CUTTERS	182	MP-18C	PAD - 460MM	40
IMP-406CB	SINGLE GAUGE 80MM (3-1/8")	207	IMPERIAL	IMPERIAL TUBE DEBURRING	195	MP-18E	PAD - 460MM	40
IMP-406CB	RUBBER BOOTS KIT - BLUE & RED	207	IMPERIAL	IMPERIAL VAK-CHECK	211	MP-2	RUBBER ANTI-VIBRATION PAD - 50MM	40
IMP-406CR	SINGLE GAUGE 63MM (2-1/2")	207	INS-TAPE-10-PK	PVC COATED WEATHERPROOF INSULATION TAPE	101, 102	MP-2C	PAD - 50MM	40
IMP-406CR	SINGLE GAUGE 80MM (3-1/8")	207	IS-3P-20A	3 POLE ROTARY ENCLOSED ISOLATOR	10, 98, 132	MP-2E	PAD - 50MM	40
IMP-406CR	MANIFOLD DIAPHRAGM REPAIR KIT	207	IS-3P-20A-S	3 POLE ROTARY ENCLOSED ISOLATOR	10, 98, 132	MP-3	RUBBER ANTI-VIBRATION PAD - 80MM	40
IMP-407CB	SINGLE GAUGE 63MM (2-1/2")	207	IS-3P-32A	3 POLE ROTARY ENCLOSED ISOLATOR	10, 98, 132	MP-3C	PAD - 80MM	40
IMP-407CB	SINGLE GAUGE 80MM (3-1/8")	207	IS-3P-32A-S	3 POLE ROTARY ENCLOSED ISOLATOR	10, 98, 132	MP-3E	PAD - 80MM	40
IMP-407CB	REPLACEMENT VAC & REF KNOB KIT WITH STEMS	207	IS-3P-40A	3 POLE ROTARY ENCLOSED ISOLATOR	10, 98, 132	MP-4	RUBBER ANTI-VIBRATION PAD - 100MM	40
IMP-407CR	SINGLE GAUGE 63MM (2-1/2")	207	IS-3P-63A	3 POLE ROTARY ENCLOSED ISOLATOR	10, 98, 132	MP-4C	PAD - 100MM	40
IMP-407CR	SINGLE GAUGE 80MM (3-1/8")	207	IS-4P-20A	4 POLE ROTARY ENCLOSED ISOLATOR	10, 98, 132	MP-4E	PAD - 100MM	40
IMP-407CR	REPLACEMENT HI & LO KNOB KIT WITH STEMS	207	IS-4P-20A-S	4 POLE ROTARY ENCLOSED ISOLATOR	10, 98, 132	MP-6	RUBBER ANTI-VIBRATION PAD - 150MM	40
IMP-408CB	SINGLE GAUGE 63MM (2-1/2")	207	IS-4P-32A	4 POLE ROTARY ENCLOSED ISOLATOR	10, 98, 132	MP-6C	PAD - 150MM	40
IMP-408CB	SINGLE GAUGE 80MM (3-1/8")	207	IS-4P-32A-S	4 POLE ROTARY ENCLOSED ISOLATOR	10, 98, 132	MP-6E	PAD - 150MM	40
IMP-408CB	REPLACEMENT VAC, REF, HT, LO, KNOB KIT	207	IS-4P-40A	4 POLE ROTARY ENCLOSED ISOLATOR	10, 98, 132	MP-805MRY	SINGLE HOSES 1/4" X 1/4" (YELLOW)	206
IMP-408CR	SINGLE GAUGE 63MM (2-1/2")	207	IS-4P-63A	4 POLE ROTARY ENCLOSED ISOLATOR	10, 98, 132	MPF-12	PROTECTION FLEECE - 2000MM X 1000MM	111, 113
IMP-408CR	SINGLE GAUGE 80MM (3-1/8")	207	ISO-18	ISO CUBE NATURAL RUBBER PADS - 460MM	40	MSA-44	ADAPTOR - SAE FEMALE TO MNPT ACCESS FITTING	49
IMP-408CR	REPLACEMENT HANGING HOOK	207	ISO-4	ISO CUBE NATURAL RUBBER PADS - 100MM	40	O1714	FOAM SEALANT - 355ML	69
IMP-420RCKP	SINGLE GAUGE 63MM (2-1/2")	207	K100-118	K-KLAMP PIPE AND INSULATION CLAMP - 1-1/8"	7, 44, 131	O1724	FOAM SEALANT - 595ML	69
IMP-420RCKP	SINGLE GAUGE 80MM (3-1/8")	207	K100-12	K-KLAMP PIPE AND INSULATION CLAMP - 1/2"	7, 44, 131	OIL & LUBRICANT	OIL & LUBRICANT	134
IMP-420RCKP	SINGLE GAUGE 63MM (2-1/2")	207	K100-138	K-KLAMP PIPE AND INSULATION CLAMP - 1-3/8"	7, 44, 131	OTHER PUMPS	OTHER PUMPS	77
IMP-420RCKP	SINGLE GAUGE 80MM (3-1/8")	207	K100-158	K-KLAMP PIPE AND INSULATION CLAMP - 1-5-8"	7, 44, 131	P3000	SPIN PLUMBING 1/2, 3/4, 1"	181
IMP-453CB	SINGLE GAUGE 63MM (2-1/2")	207	K100-218	K-KLAMP PIPE AND INSULATION CLAMP - 2-1/8"	7, 44, 131	PAC-C-12-R290	PORTABLE (COOLING)	42, 88
IMP-453CB	SINGLE GAUGE 80MM (3-1/8")	207	K100-258	K-KLAMP PIPE AND INSULATION CLAMP - 2-5/8"	7, 44, 131	PAC-H-12-R290	PORTABLE (HEAT PUMP)	42, 88
IMP-453CR	SINGLE GAUGE 63MM (2-1/2")	207	K100-318	K-KLAMP PIPE AND INSULATION CLAMP - 3-1/8"	7, 44, 131	PE2-YSA	LITTLE GIANT SMALL SUBMERSIBLE PUMP	78
IMP-453CR	SINGLE GAUGE 80MM (3-1/8")	207	K100-34	K-KLAMP PIPE AND INSULATION CLAMP - 3/4"	7, 44, 131	PF-16-EU	DIVERSI-FLUSH SOLVENT REFILL	58
IMP-538FTY	VACUUM HOSES 3/8" X 3/8" (YELLOW)	206	K100-358	K-KLAMP PIPE AND INSULATION CLAMP - 3-5/8"	7, 44, 131	PF-87018	PRO-FIT 1/4" QUICK CONNECT UNION	72
IMP-540CB	MANIFOLD NO SIGHT GLASS, 4 PORT 63MM GAUGES	205	K100-418	K-KLAMP PIPE AND INSULATION CLAMP - 4-1/8"	7, 44, 131	PF-87019	PRO-FIT 3/8" QUICK CONNECT UNION	72
IMP-540CB-36-PH	MANIFOLD NO SIGHT GLASS, 4 PORT 63MM GAUGES	205	K100-58	K-KLAMP PIPE AND INSULATION CLAMP - 5/8"	7, 44, 131	PF-87020	PRO-FIT 1/2" QUICK CONNECT UNION	72
IMP-540CB-60-PH	MANIFOLD NO SIGHT GLASS, 4 PORT 63MM GAUGES	205	K100-78	K-KLAMP PIPE AND INSULATION CLAMP - 7/8"	7, 44, 131	PF-87021	PRO-FIT 5/8" QUICK CONNECT UNION	72
IMP-540CB-72-PH	MANIFOLD NO SIGHT GLASS, 4 PORT 63MM GAUGES	205	K12-100	K-KLAMP PIPE AND INSULATION CLAMP - 1"	7, 44, 131	PF-87022	PRO-FIT QUICK 3/4" QUICK CONNECT UNION	72
IMP-560CB	MANIFOLD WITH SIGHT GLASS, 5 PORT 63MM GAUGES	205	K12-118	K-KLAMP PIPE AND INSULATION CLAMP - 1-1/8"	7, 44, 131	PF-87023	PRO-FIT QUICK 7/8" QUICK CONNECT UNION	72
IMP-560CB-36-PH	MANIFOLD WITH SIGHT GLASS, 5 PORT 63MM GAUGES	205	K12-12	K-KLAMP PIPE AND INSULATION CLAMP - 1/2"	7, 44, 131	PF-87024	PRO-FIT 1/4" QUICK CONNECT 90 ELBOW	72
IMP-560CB-60-PH	MANIFOLD WITH SIGHT GLASS, 5 PORT 63MM GAUGES	205	K12-138	K-KLAMP PIPE AND INSULATION CLAMP - 1-3/8"	7, 44, 131	PF-87025	PRO-FIT 3/8" QUICK CONNECT 90 ELBOW	72
IMP-560CB-72-PH	MANIFOLD WITH SIGHT GLASS, 5 PORT 63MM GAUGES	205	K12-158	K-KLAMP PIPE AND INSULATION CLAMP - 1-5-8"	7, 44, 131	PF-87026	PRO-FIT 1/2" QUICK CONNECT 90 ELBOW	72
IMP-572FY	VACUUM HOSES 3/8" X 3/8" (YELLOW)	206	K12-218	K-KLAMP PIPE AND INSULATION CLAMP - 2-1/8"	7, 44, 131	PF-87030	PRO-FIT 1/8" - 3/8" REDUCER	72
IMP-800MBS	6" LOW LOSS BALL VALVE ADAPTOR HOSE 1/4" X 1/4"	206	K12-258	K-KLAMP PIPE AND INSULATION CLAMP - 2-5/8"	7, 44, 131	PF-87031	PRO-FIT 3/8" - 1/2" REDUCER	72
IMP-803MRB	SINGLE HOSES 1/4" X 1/4" (BLUE)	206	K12-318	K-KLAMP PIPE AND INSULATION CLAMP - 3-1/8"	7, 44, 131	PF-87032	PRO-FIT 1/2" - 5/8" REDUCER	72
IMP-803MRR	SINGLE HOSES 1/4" X 1/4" (RED)	206	K12-34	K-KLAMP PIPE AND INSULATION CLAMP - 3/4"	7, 44, 131	PF-87036	PRO-FIT 1/4" QUICK CONNECT SOCKET	72
IMP-803MRS	STANDARD HOSE SET 1/4" X 1/4" (RED, YELLOW, BLUE)	206	K12-358	K-KLAMP PIPE AND INSULATION CLAMP - 3-5/8"	7, 44, 131	PF-87037	PRO-FIT 3/8" QUICK CONNECT SOCKET	72
IMP-803MRY	SINGLE HOSES 1/4" X 1/4" (YELLOW)	206	K12-38	K-KLAMP PIPE AND INSULATION CLAMP - 3/8"	7, 44, 131	PF-87038	PRO-FIT 1/2" QUICK CONNECT SOCKET	72
IMP-805MRB	SINGLE HOSES 1/4" X 1/4" (BLUE)	206	K12-418	K-KLAMP PIPE AND INSULATION CLAMP - 4-1/8"	7, 44, 131	PF-87042	PRO-FIT 1/4" QUICK CONNECT VALVE	72

CODE	DESCRIPTION	PAGE	CODE	DESCRIPTION	PAGE	CODE	DESCRIPTION	PAGE
PF-87043	PRO-FIT 3/8" QUICK CONNECT VALVE	72	RA-15121A	ROBINAIR COOLTECH VACUUM PUMP - 10CFM	172	SC06-22	M6 STUD CLIP - 7/8"	47
PF-87044	PRO-FIT 1/2" QUICK CONNECT VALVE	72	RA-15301A-E	ROBINAIR VACUMASTER VACUUM PUMP - 3CFM	173	SC06-25	M6 STUD CLIP - 1"	47
PF-87048	PRO-FIT 1/4" - 5/8" SUPPORT KIT	72	RA-15401	ROBINAIR COOLTECH VACUUM PUMP - 4CFM	172	SC06-28	M6 STUD CLIP - 1-1/8"	47
PF-87049	PRO-FIT 3/4" - 7/8" SUPPORT KIT	72	RA-15501A-E	ROBINAIR VACUMASTER VACUUM PUMP - 5CFM	173	SC06-32	M6 STUD CLIP - 1-1/4"	47
PF-ADAPTOR	LINE SET ADAPTOR	58	RA-15501A-E-A2L	VACUMASTER ROBINAIR VACUUM PUMP 5CFM	174	SC06-35	M6 STUD CLIP - 1-3/8"	47
PF-KIT-EU	DIVERSI-FLUSH HVAC FLUSHING KIT	58	RA-15601	ROBINAIR COOLTECH VACUUM PUMP - 6CFM	172	SC06-40	M6 STUD CLIP - 1-1/2"	47
PH-08L-HL	PUMP HOUSE 0.8 LITRE TANK PUMP	82	RA-15801A-E	ROBINAIR VACUMASTER VACUUM PUMP - 8CFM	173	SC06-42	M6 STUD CLIP - 1-5/8"	47
PH-08LC	PUMP HOUSE 0.8 LITRE TANK PUMP WITH COVER	82	RA-EXP	ROBINAIR HYDRAULIC PIPE EXPANDER	180	SC06-50	M6 STUD CLIP - 2"	47
PH-1L / PH-1L-SS	1LITRE TANK PUMP	89	RA-EXP-1-1/8	EXPANDER HEAD 1-1/8"	180	SC06-54	M6 STUD CLIP - 2-1/8"	47
PH-20-STA	PUMP HOUSE 2 LITRE TANK PUMP	82	RA-EXP-1-3/8"	EXPANDER HEAD 1-3/8"	180	SC08-15	STUDDING CLIP M8	47
PH-2L / PH-2L-SS	2 LITRE TANK PUMP	89	RA-EXP-1-5/8	EXPANDER HEAD 1-5/8"	180	SC08-20	STUDDING CLIP M8	47
PH-3.8L-HW	PRESSURE RELIEF AND BOILER CONDENSATE PUMP	22, 83	RA-EXP-1/2	EXPANDER HEAD 1/2"	180	SC08-22	STUDDING CLIP M8	47
PH-5L-HW	HIGH TEMPERATURE & PRESSURE RELIEF PUMP	22, 83	RA-EXP-1/4	EXPANDER HEAD 1/4"	180	SC08-25	STUDDING CLIP M8	47
PH-BF-B	FLEXI BASE FRAME	108	RA-EXP-3/4	EXPANDER HEAD 3/4"	180	SC08-28	STUDDING CLIP M8	47
PH-EF-B	FLEXI EXTENDER FRAME	108	RA-EXP-3/8	EXPANDER HEAD 3/8"	180	SC08-32	STUDDING CLIP M8	47
PH-FO-200	FLEXI FOOT - 200MM FOR VERTICAL STRUT	112	RA-EXP-5/8	EXPANDER HEAD 5/8"	180	SC08-35	STUDDING CLIP M8	47
PH-FO-350	FLEXI FOOT - 350MM FOR VERTICAL STRUT	112	RA-EXP-7/8	EXPANDER HEAD 7/8"	180	SC08-40	STUDDING CLIP M8	47
PH-FO-350-2	FLEXI FOOT - 350MM FOR VERTICAL STRUT	112	RA-EXP-C-D	ROBINAIR HYDRAULIC PIPE EXPANDER	180	SC08-42	STUDDING CLIP M8	47
PH-FO-350-2.5-S	FLEXI FOOT - 350MM FOR VERTICAL 2.5 DEGREE	112	RA-EXP-DBT	DEBURRING TOOL	180	SC08-50	STUDDING CLIP M8	47
PH-FO-350-5.0-S	FLEXI FOOT - 350MM FOR VERTICAL 5.0 DEGREE	112	RA-EXP-SET	ROBINAIR HYDRAULIC PIPE EXPANDER SET	180	SC08-54	STUDDING CLIP M8	47
PH-FO-500	FLEXI FOOT - 500MM FOR VERTICAL STRUT	112	RA-VG-64-A	DIGITAL LCD DISPLAY VACUUM GAUGE	175	SC10-15	STUDDING CLIP M10	47
PH-FO-500-2	FLEXI FOOT - 500MM FOR VERTICAL STRUT	112	RC-1	INSTA-CHARGE	74	SC10-20	STUDDING CLIP M10	47
PH-FO-500-2.5	FLEXI FOOT - 500MM FOR VERTICAL 2.5 DEGREE	112	RECOVERY MACHINES	RECOVERY MACHINES	145	SC10-22	STUDDING CLIP M10	47
PH-FO-500-5.0	FLEXI FOOT - 500MM FOR VERTICAL 5.0 DEGREE	112	REDBOX-1-L-S	1 LITRE TANK PUMP	20	SC10-25	STUDDING CLIP M10	47
PH-PUMP-NRV	NON-RETURN CHECK VALVE - 3/8" (9.5MM) PH	23, 87	REDBOX-2L-S	2 LITRE TANK PUMP	20	SC10-28	STUDDING CLIP M10	47
PH-VW-MAT-500	MAT	113	RG 3000 110V	PROMAX ULTRA COMPACT RECOVERY UNIT	148	SC10-32	STUDDING CLIP M10	47
PHF-005A	FLEXI END BAR	115	RG 3000 E	RG 3000 E PROMAX ULTRA COMPACT RECOVERY UNIT	148	SC10-35	STUDDING CLIP M10	47
PHF-005B	FLEXI END BAR	115	RG 5410A E	PROMAX RECOVERY UNIT - 110V 50-60HZ	152	SC10-40	STUDDING CLIP M10	47
PHF-005C	FLEXI END BAR	115	RG 5410A E240V	PROMAX RECOVERY UNIT - 240V 50-60HZ	152	SC10-42	STUDDING CLIP M10	47
PHF-005D	FLEXI END BAR	115	RLC-015	PIPE CLAMP M8-10 RUBBER LINED	45, 130	SC10-50	STUDDING CLIP M10	47
PHF-016	FLEXI CROSS BAR	115	RLC-020	PIPE CLAMP M8-10 LINED	45, 130	SC10-54	STUDDING CLIP M10	47
PHF-016B	FLEXI CROSS BAR	115	RLC-020-GS	SINGLE HINGED PIPE CLAMP M8-10 LINED	45, 131	SCALES	REFRIGERANT WEIGHING SCALES	163
PHF-016C	FLEXI CROSS BAR	115	RLC-024	PIPE CLAMP M8-10 LINED 1/2" 20-24MM	45, 130	SCM-5	GRIP- CUT OPEN MESH SAND SCREEN CLOTH	75, 90
PHF-016D	FLEXI CROSS BAR	115	RLC-024-GS	SINGLE HINGED PIPE CLAMP M8-10 LINED	45, 131	SMELL-BUSTER	SMELL BUSTER - 60G TABLES (PACK OF 2)	57
PHFO16A	FLEXI CROSS BAR	115	RLC-029	PIPE CLAMP M8-10 LINED 3/4" 25-29MM	45, 130	SMELL-BUSTER-8	SMELL BUSTER - 225G (TUB)	57
PP-215-NRV	NON-RETURN VALVE	93	RLC-029-GS	SINGLE HINGED PIPE CLAMP M8-10 LINED	45, 131	SMELL-BUSTER-SMALL	SMELL BUSTER - 12G TABLES (PACK OF 10)	57
PP-45EL-215-B	PLASTIC PIPE - 45 DEGREE ELBOW	93	RLC-035	PIPE CLAMP M8-10 LINED 1" 32-36MM	45, 130	SOAKY	SOAKAWAY KIT FOR CONDENSING BOILERS	86
PP-45EL-215-W	PLASTIC PIPE - 45 DEGREE ELBOW	93	RLC-035-GS	SINGLE HINGED PIPE CLAMP M8-10 LINED	45, 131	SPARK KEY	SPARK-KEY TORCH IGNITER	76
PP-90EL-215-B	PLASTIC PIPE - 90 DEGREE ELBOW	93	RLC-042-GS	SINGLE HINGED PIPE CLAMP M8-10 LINED	45, 131	SPIN-CASE-F	SPIN SOFT DELUXE CASE - FLARING	181
PP-90EL-215-W	PLASTIC PIPE - 90 DEGREE ELBOW	93	RLC-044	PIPE CLAMP M8-10 LINED 1-1/4" 37-44MM	45, 130	SPIN-CASE-S	SPIN SOFT DELUXE CASE - SWAGING	181
PP-CL-15-W	PLASTIC PIPE CLIP	93	RLC-050	PIPE CLAMP M8-10 LINED 1-1/2" 44-50MM	45, 130	SPIN-X6000	SPIN SWAGING / FLARING TOOL SET	181
PP-CL-215-W-32-40	PIPE CLAMP KIT	93	RLC-053-GS	SINGLE HINGED PIPE CLAMP M8-10 LINED	45, 131	SV-ADAPTOR	SELF-SEALING PIPE ADAPTOR	23, 87
PP-CL-22-W	PLASTIC PIPE CLIP	93	RLC-058	PIPE CLAMP M8-10 LINED 50-58MM	45, 130	SV-ADAPTOR-6	SELF-SEALING PIPE ADAPTOR	23, 87
PP-CL-28-W	PLASTIC PIPE CLIP	93	RLC-065-GS	SINGLE HINGED PIPE CLAMP M8-10 LINED	45, 131	SVA-3	SELF-SEALING PIPE ADAPTOR	23, 87
PP-CL-32-B	PLASTIC PIPE CLIP	93	RLC-068	PIPE CLAMP M8-10 LINED 2" 58-68MM	45, 130	SVA-6-3	SELF-SEALING PIPE ADAPTOR	23, 87
PP-CL-32-G	PLASTIC PIPE CLIP	93	RLC-078	PIPE CLAMP M8-10 LINED 2-1/2" 68-78MM	45, 130	T-1	HANDLE ONLY	60
PP-CL-32-W	PLASTIC PIPE CLIP	93	RLC-088	PIPE CLAMP M8-10 LINED 78-88MM	45, 130	T-10	HEAD 10 FPI - NEUTRAL	60
PP-CL-40-B	PLASTIC PIPE CLIP	93	RLC-098	PIPE CLAMP M8-10 LINED 3" 88-98MM	45, 130	T-100	KIT 1 - HANDLE WITH 6 HEADS	60
PP-CL-40-G	PLASTIC PIPE CLIP	93	RLC-108	PIPE CLAMP M8-10 LINED 3-1/2" 98-108MM	45, 130	T-101	KIT 2 - HANDLE WITH 6 HEADS	60
PP-CL-40-W	PLASTIC PIPE CLIP	93	RLC-118	PIPE CLAMP M8-10 LINED 4" 108-118MM	45, 130	T-11	HEAD 11 FPI - BLUE	60
PP-CON-215-B	PLASTIC PIPE - STRAIGHT CONNECTOR	93	RLC-128	PIPE CLAMP M8-10 LINED 118-128MM	45, 130	T-12	HEAD 12 FPI - GREEN	60
PP-CON-215-W	PLASTIC PIPE - STRAIGHT CONNECTOR	93	RLC-138	PIPE CLAMP M8-10 LINED 128-138MM	45, 130	T-13	HEAD 13 FPI - PINK	60
PP-PIPE-215-B	PLASTIC PIPE	93	RLC-148	PIPE CLAMP M8-10 LINED 135-148MM	45, 130	T-14	HEAD 14 FPI - LIGHT GREEN	60
PP-PIPE-215-W	PLASTIC PIPE	93	RLC-164	PIPE CLAMP M8-10 LINED 151-164MM	45, 130	T-15	HEAD 15 FPI - AQUA	60
PP-SOBOS-110-B-32	STRAP ON BOSS	94	RLC-175	PIPE CLAMP M8-10 LINED 6" 165-175MM	45, 130	T-16	HEAD 16 FPI - BROWN	60
PP-SOBOS-110-B-40	STRAP ON BOSS	94	RLC-185	PIPE CLAMP M8-10 LINED 175-185MM	45, 130	T-20	HEAD 20 FPI - PURPLE	60
PP-SOBOS-110-G-32	STRAP ON BOSS	94	RLC-205	PIPE CLAMP M8-10 LINED 194-205MM	45, 130	T-200	FIN TOOL	60
PP-SOBOS-110-G-40	STRAP ON BOSS	94	RPC-0012	RPC CHANNEL CLIP 1/2	46	T-21	HEAD 21&22 FPI - ROSE	60
PP-T-215-B	PLASTIC PIPE - T CONNECTOR	93	RPC-0014	RPC CHANNEL CLIP 1/4	46	T-300	FIN TOOL WITH HEAVY DUTY BICYCLE HANDLE	60
PP-T-215-W	PLASTIC PIPE - T CONNECTOR	93	RPC-0034	RPC CHANNEL CLIP 3/4	46	T-400	SET OF 6 T-408, T409, T-410, T411, T417, T418	60
PP-UNI-CL-W-32-40	PIPE CLAMP - HOSE CONNECTOR	93	RPC-0038	RPC CHANNEL CLIP 3/8	46	T-408	8 AND 10 FPI - ORANGE	60
PP-UNI-NRV	NON-RETURN VALVE - WITH HOSE FITTING	93	RPC-0058	RPC CHANNEL CLIP 5/8	46	T-409	9 AND 15 FPI - YELLOW	60
PRO-BUBBLE-32	PRO-BUBBLE LEAK DETECTOR SPRAY	68	RPC-0078	RPC CHANNEL CLIP 7/8	46	T-411	11 AND 13 FPI - BLUE	60
PRO-CARE-GB	EVAPORATOR COIL CLEANER WITH DISINFECTANT	56	RPC-0118	RPC CHANNEL CLIP 1-1/8	46	T-412	12 AND 14 FPI - GREEN	60
PRO-CLEAN-GB	EVAPORATOR & CONDENSING COIL CLEANER	56	RPC-0138	RPC CHANNEL CLIP 1-3/8	46	T-417	16 AND 17 FPI - LIME	60
PRO-COOL-GB	NON-ODOUR LIQUID ICE MACHINE CLEANER	56	RPC-0158	RPC CHANNEL CLIP 1-5/8	46	T-418	18 AND 20 FPI - RED	60
PRO-FOAM-GB	HEAVY DUTY CONDENSING COIL CLEANER	56	RVT-1/2	CLEAR 1/2" X 30 METRES CONDENSATE BRAIDED HOSE	24	T-8	HEAD 8 FPI - ORANGE	60
PRO-GREEN-GB	PRO-GREEN 5 LITRE CONCENTRATED COIL CLEANER	56, 105	RVT-1/2-6	CLEAR 1/2" X 6 METRES CONDENSATE BRAIDED HOSE	24	T-9	HEAD 9 FPI - YELLOW	60
PRO-SCALE-GB	CONCENTRATED - LIME SCALE REMOVER	56	RVT-1/2-B	BLACK 1/2" X 30 METRES CONDENSATE BRAIDED HOSE	24	TE3-MD-HC	LITTLE GIANT MAGNETIC DRIVE TE3 SERIES PUMP	79
PRO-TREAT 151	PRO-TREAT 151 PREMIUM DRAIN PAN TABLETS	70	RVT-1/4	CLEAR 1/4" X 30 METRES CONDENSATE BRAIDED HOSE	24	TE3-MD-SC	LITTLE GIANT MAGNETIC DRIVE TE3 SERIES PUMP	79
PRO-UNIV-GB	INDOOR & OUTDOOR COIL CLEANER	56	RVT-1/4-B	BLACK 1/4" X 30 METRES CONDENSATE BRAIDED HOSE	24	TE4-MD-HC	LITTLE GIANT MAGNETIC DRIVE TE4 SERIES PUMP	79
QSMS1201	QUICK SLING STAND - LOW	41	RVT-3/4-6	CLEAR 3/4" X 6 METRES CONDENSATE BRAIDED HOSE	24	TE4-MD-SC	LITTLE GIANT MAGNETIC DRIVE TE4 SERIES PUMP	79
QSMS1801	QUICK SLING STAND - MEDIUM	41	RVT-3/8	CLEAR 3/8" X 30 METRES CONDENSATE BRAIDED HOSE	24, 87	TE5-MD-HC	LITTLE GIANT MAGNETIC DRIVE TE5 SERIES PUMP	79
QSMS2401	QUICK SLING STAND - HIGH	41	RVT-3/8-B	BLACK 3/8" X 30 METRES CONDENSATE BRAIDED HOSE	24	TE5-MD-SC	LITTLE GIANT MAGNETIC DRIVE TE5 SERIES PUMP	79
QT-1	QUICK TAP - 1/4", 5/16", 3/8"	71	RVT-5/8	CLEAR 5/8" X 30 METRES CONDENSATE BRAIDED HOSE	24	TE5.5-MD-HC	LITTLE GIANT MAGNETIC DRIVE TE5.5 SERIES PUMP	79
QT-100	QUICK TAP 2 - 1/4", 5/16", 3/8"	71	S1012	SPIN 1/2"	181	TE5.5-MD-SC	LITTLE GIANT MAGNETIC DRIVE TE5.5 SERIES PUMP	79
QT-100G	REPLACEMENT GASKET ONLY	71	S1014	SPIN 1/4"	181	TE6-MD-HC	LITTLE GIANT MAGNETIC DRIVE TE6 SERIES PUMP	79
QT-100N	REPLACEMENT STEEL NEEDLE AND GASKET	71	S1034	SPIN 3/4"	181	TE6-MD-SC	LITTLE GIANT MAGNETIC DRIVE TE6 SERIES PUMP	79
QT-2	QUICK TAP - 1/2", 5/8"	71	S1038	SPIN 3/8"	181	TE7-MD-HC	LITTLE GIANT MAGNETIC DRIVE TE7 SERIES PUMP	79
QTH-1	QUICK TAP 2 - 1/4", 5/16", 3/8"	71	S1058	SPIN 5/8"	181	TE7-MD-SC	LITTLE GIANT MAGNETIC DRIVE TE7 SERIES PUMP	79
QTH-2	QUICK TAP 2 - 1/2", 5/8"	71	S1078	SPIN 7/8"	181	TF 8801	REPLACEMENT SENSOR	161
QTM-1	LINE PIERCING VALVE - 1/4", 5/16", 3/8"	71	S1516	SPIN 5/16"	181	TF 8806-A	RECHARGEABLE BATTERIES (2 EACH)	161
QTM-2	LINE PIERCING VALVE - 1/2", 5/8"	71	S4000	SPIN 1/4, 3/8, 1/2, 5/8	181	TF 8806-B	BATTERY CHARGER 240V	161
REFRIGERATION	REFRIGERATION	6	S5000	SPIN 1/4, 3/8, 1/2, 5/8, 3/4	181	TF 8900-E	COMBUSTIBLE GAS LEAK DETECTOR	161
RA 41174E300C	ROBINAIR 2-WAY MANIFOLD	204	S6000	SPIN 1/4, 3/8, 1/2, 5/8, 3/4, 7/8	181	TF ZX-14	FILTER & TIP FOR ZX-14	159
RA-13119	PREMIUM HIGH VACUUM PUMP OIL	135, 176	SC-10	ABRASIVE CLOTH - 120 GRIT - 1-1/2" X 10 YARDS	75, 90	TF ZX-1A	HEATED PENTODE™ REFRIGERANT LEAK DETECTOR	159
RA-13203	PREMIUM HIGH VACUUM PUMP OIL	176	SC06-15	M6 STUD CLIP - 5/8"	47	TF ZX-2	HEATED PENTODE™ SENSOR FOR ZX-1A	159
RA-13204	PREMIUM HIGH VACUUM PUMP OIL	135, 176	SC06-20	M6 STUD CLIP - 3/4"	47	TF ZX-20	NICKLE-METAL HYDRIDE (NMH) BATTERY PACK	159

INDEX BY CODE



CODE	DESCRIPTION	PAGE	CODE	DESCRIPTION	PAGE	CODE	DESCRIPTION	PAGE
TIF-9000S	TIF DUAL RANGE COMPACT REFRIGERANT SCALE	164	VUR-4	FULL UNION ACCESS FITTING	49	X-CHCB-4121B6	PLASTIC END CAPS - 41MM X 21MM	122
TIF-9060S	TIF HEAVY-DUTY ALUMINIUM SCALE UP TO 150 KG	166	VVC-1	REPLACEMENT VALVE CORE TOOL ACCESS FITTING	49	X-CHCB-4141	PLASTIC END CAPS - 41MM X 41MM	122
TIF-9010A	TIF "SLIMLINE" REFRIGERANT SCALE UP TO 50KG	169	WAC-Q-12-INV	THROUGH-THE-WALL AC	42	X-CHCB-4141B6	PLASTIC END CAPS - 41MM X 41MM	122
TIF-9030E	TIF COMPACT REFRIGERANT SCALE UP TO 100 KG	165	WHISPA-Q-2L	2 LITRE TANK PUMP	19	X-CHCW-4121	PLASTIC END CAPS - 41MM X 21MM	122
TIF-9055	TIF CHARGING / RECOVERY SCALE UP TO 100 KG	168	WHISPA-Q-1L	1 LITRE TANK PUMP	19	X-CHCW-4121B6	PLASTIC END CAPS - 41MM X 21MM	122
TIF-XP-1A	AUTOMATIC HALOGEN REFRIGERANT LEAK DETECTOR	158	WHISPA-Q-MINI	MINI PUMP	21	X-CHCW-4141	PLASTIC END CAPS - 41MM X 41MM	122
TIF-IR-1A	INFRARED SENSOR LEAK DETECTOR	160	WHISPA-Q-TRUNK	MINI PUMP WITH TRUNKING	21	X-CHCW-4141B6	PLASTIC END CAPS - 41MM X 41MM	122
TIF-XP-2	MAINTENANCE KIT (3 TIPS WITH PROTECTORS)	158	X-IGDPSW-13A	SWITCH 1 GANG - 13 AMP	89,132	X-CHWF-1	CHANNEL WING FITTING TYPE 1	120
TIF-IR-8	MAINTENANCE KIT 5 X FILTERS AND 3 X O RINGS	160	X-2GDPSW-10A	SWITCH 2 GANG - 10 AMP	89,132	X-CHWF-2	CHANNEL WING FITTING TYPE 2	120
TIF-XP1A	TIF ELECTRONIC LEAK DETECTOR	105	X-2GSWZ-10A	SWITCH 2 GANG - 10 AMP	89,132	X-CHWF-3	CHANNEL WING FITTING TYPE 3	120
TOOLS	TOOLS	143	X-3GSWZ-10A	SWITCH 3 GANG - 10 AMP	89,132	X-CHWF-4	CHANNEL WING FITTING TYPE 4	120
TR-CP-140	140MM STRAIGHT CONNECTOR	104	X-AB-8/10-100-B4	ANCHOR BOLT 8MM 0-100	128	X-CHZB-4121	CHANNEL Z BRACKET - 41MM X 21MM	121
TR-CP-140-B	140MM STRAIGHT CONNECTOR	104	X-AB-ML 0-60-B100	ANCHOR BOLT 8MM 0-60	128	X-CHZB-4141	CHANNEL Z BRACKET - 41MM X 41MM	121
TR-D-140	140MM TRUNKING (2000MM LENGTH)	104	X-AB-ML 0-60-B4	ANCHOR BOLT 8MM 0-60	128	X-CIC4H-4121	CHANNEL 4-HOLE INTERNAL CONNECTOR	121
TR-D-140-B	140MM TRUNKING (2000MM LENGTH)	104	X-AB-ML 0-B100	ANCHOR BOLT 8MM 0-100	128	X-CIC4H-4141	CHANNEL 4-HOLE INTERNAL CONNECTOR	121
TR-EC-140	90 DEGREE EXTERNAL BEND	104	X-BBSM-25	BACK BOX SURFACE MOUNT - 25MM	89,132	X-CN-M6-B100	PLAIN CHANNEL NUT	126
TR-EC-140-B	140MM STRAIGHT CONNECTOR	104	X-BBSM-35	BACK BOX SURFACE MOUNT - 35MM	89,132	X-CN-M6-B100	PLAIN CHANNEL NUT	126
TR-EC-140-B	90 DEGREE EXTERNAL BEND	104	X-BBSM26-25	BACK BOX 2 GANG - 25MM	89,132	X-CN-M10-B100	PLAIN CHANNEL NUT	126
TR-FB-140	90 DEGREE FLAT BEND	104	X-BBSM20-35	BACK BOX 2 GANG - 35MM	89,132	X-CN-M12-B100	PLAIN CHANNEL NUT	126
TR-FB-140-B	90 DEGREE FLAT BEND	104	X-BGC-M10	BEAM G CLAMP	120	X-CN-M6-B8	PLAIN CHANNEL NUT	126
TR-IC-140	140MM 90 DEGREE INTERNAL BEND	104	X-BGC-M12	BEAM G CLAMP	120	X-CN-M8-B8	PLAIN CHANNEL NUT	126
TR-IC-140-B	140MM 90 DEGREE INTERNAL/EXTERNAL BEND	104	X-BGC-M10	BEAM G CLAMP	120	X-CN-M10-B8	PLAIN CHANNEL NUT	126
TR-WC-140	140MM WALL COVER	104	X-BGC-M8	BEAM G CLAMP	120	X-CN-M12-B8	PLAIN CHANNEL NUT	126
TR-WC-140-B	140MM WALL COVER	104	X-BP810	BACK PLATE - MB/ ML 0	120	X-CNLS-M10-B100	LONG SPRING CHANNEL NUT	126
TRH-1	THREADED ROD HANGER - SIZE 1	43	X-BSPS-10A	PLUG SOCKET - 10 AMP	89	X-CNLS-M10-B6	LONG SPRING CHANNEL NUT	126
TRH-2	THREADED ROD HANGER - SIZE 2	43	X-BSPS-L0A	PLUG SOCKET - 10 AMP	132	X-CNLS-M12-B100	LONG SPRING CHANNEL NUT	126
TRH-3	THREADED ROD HANGER - SIZE 3	43	X-BT-100	BASKET TRAY - 100MM X 60MM X 3M	124	X-CNLS-M12-B6	LONG SPRING CHANNEL NUT	126
TRH-4	THREADED ROD HANGER - SIZE 4	43	X-BT-150	BASKET TRAY - 150MM X 60MM X 3M	124	X-CNLS-M6-B100	LONG SPRING CHANNEL NUT	126
TW-KIT	SLEEVED PVC COATED INSULATION KIT	88,102	X-BT-200	BASKET TRAY - 200MM X 60MM X 3M	124	X-CNLS-M6-B6	LONG SPRING CHANNEL NUT	126
UC1638-3	ULTRALITE EQUIPMENT PAD 75X400X900	38	X-BT-300	BASKET TRAY - 300MM X 60MM X 3M	124	X-CNLS-M8-B100	LONG SPRING CHANNEL NUT	126
UC2424-3	ULTRALITE EQUIPMENT PAD 75X400X900	38	X-BT-400	BASKET TRAY - 400MM X 60MM X 3M	124	X-CNLS-M8-B6	LONG SPRING CHANNEL NUT	126
UC2436-3	ULTRALITE EQUIPMENT PAD 75X400X900	38	X-BT-450	BASKET TRAY - 450MM X 60MM X 3M	124	X-CNLS-M10-B100	LONG SPRING CHANNEL NUT	126
UC2442-3	ULTRALITE EQUIPMENT PAD 75X400X900	38	X-BT-500	BASKET TRAY - 500MM X 60MM X 3M	124	X-CNLS-M10-B6	LONG SPRING CHANNEL NUT	126
UC2448-3	ULTRALITE EQUIPMENT PAD 75X400X900	38	X-BT-60	BASKET TRAY - 60MM X 60MM X 3M	124	X-CNLS-M12-B100	LONG SPRING CHANNEL NUT	126
UV-1	ULTRAVIOLET LIGHT WITH 24 VAC ELEC. BALLAST	62	X-BT-600	BASKET TRAY - 600MM X 60MM X 3M	124	X-CNLS-M12-B6	LONG SPRING CHANNEL NUT	126
UVEC-07G	THE PURIFIER - 12V CHARGER	63	X-BT-CH	BASKET TRAY CENTRAL SUPPORT HANGERS - PAIR	124	X-CNLS-M6-B100	LONG SPRING CHANNEL NUT	126
VA-3-346	3-WAY SOLDER FITTING ACCESS FITTING	49	X-BT-FC	BASKET CORNER CONNECTOR	124	X-CNLS-M6-B6	LONG SPRING CHANNEL NUT	126
VA-34	STRAIGHT SOLDER FITTING ACCESS FITTING	49	X-BT-HDC	BASKET TRAY HOLD DOWN CLAMP	124	X-CNLS-M8-B100	LONG SPRING CHANNEL NUT	126
VA-46	STRAIGHT SOLDER FITTING ACCESS FITTING	49	X-BT-PC	BASKET CLAMPING PIECE - PACK OF 50	124	X-CNLS-M8-B6	LONG SPRING CHANNEL NUT	126
VA-68	STRAIGHT SOLDER FITTING ACCESS FITTING	49	X-BT-SH	BASKET TRAY SUSPENSION HANGER	124	X-CS-M1030-B100	COACH SCREW 30MM	127
VACUUM PUMPS	VACUUM PUMPS	171	X-BTC	BASKET TRAY COUPLERS - PAIR	124	X-CS-M1030-B5	COACH SCREW 30MM	127
VAU-24	HALF UNION ACCESS FITTING	49	X-BTBC-150	BASKET TRAY CEILING BRACKET - 150MM	124	X-CS-M1050-B100	COACH SCREW 50MM	127
VAU-45	HALF UNION ACCESS FITTING	49	X-BTBC-200	BASKET TRAY CEILING BRACKET - 200MM	124	X-CS-M1050-B5	COACH SCREW 50MM	127
VAX-3	EXTENDED COPPER TUBE FITTING ACCESS FITTING	49	X-BTBC-300	BASKET TRAY CEILING BRACKET - 300MM	124	X-CS-M830-B100	COACH SCREW 30MM	127
VAX-4	EXTENDED COPPER TUBE FITTING ACCESS FITTING	49	X-BTJ	BASKET TRAY JOINTING KIT - 4 PART KIT	124	X-CS-M830-B5	COACH SCREW 30MM	127
VAX-4B	EXTENDED COPPER TUBE FITTING ACCESS FITTING	49	X-BTM-100	BASKET TRAY QUICK CONNECT - 100 X 60 X 3MM	124	X-CS-M850-B100	COACH SCREW 50MM	127
VAX-4B-6	EXTENDED COPPER TUBE FITTING ACCESS FITTING	49	X-BTM-150	BASKET TRAY QUICK CONNECT - 150 X 60 X 3MM	124	X-CS-M850-B5	COACH SCREW 50MM	127
VAX-5	EXTENDED COPPER TUBE FITTING ACCESS FITTING	49	X-BTM-200	BASKET TRAY QUICK CONNECT - 200 X 60 X 3MM	124	X-CSG-20B-B10	CABLE STUFFING GLAND - 20MM	132
VAX-5-PH	EXTENDED COPPER TUBE FITTING ACCESS FITTING	49	X-BTM-300	BASKET TRAY QUICK CONNECT - 300 X 60 X 3MM	124	X-CSG-20W-B10	CABLE STUFFING GLAND - 20MM	132
VAX-6	EXTENDED COPPER TUBE FITTING ACCESS FITTING	49	X-BTWS-150	BASKET TRAY WALL SUPPORT BRACKET - 150MM	124	X-CSG-25B-B10	CABLE STUFFING GLAND - 25MM	132
VC-4	SAE FLARE CAP 1/4 ACCESS FITTING	49	X-BTWS-200	BASKET TRAY WALL SUPPORT BRACKET - 200MM	124	X-CSG-25W-B10	CABLE STUFFING GLAND - 25MM	132
VC-4R	SAE FLARE CAP 1/4 ACCESS FITTING	49	X-BTWS-300	BASKET TRAY WALL SUPPORT BRACKET - 300MM	124	X-CT300-4.8B-B100	CABLE TIE 300MM X 4.8MM - BLACK	133
VCCA-20S	1 LITRE TANK PUMP	19	X-BTWS-400	BASKET TRAY WALL SUPPORT BRACKET - 400MM	124	X-CT300-4.8W-B100	CABLE TIE 300MM X 4.8MM - WHITE	133
VCL-24S	3.8 LITRE TANK PUMP	19	X-CB28-BL-B100	CABLE TIE BASE - 28MM SELF ADHESIVE - BLACK	133	X-CT300-7.6B-B100	CABLE TIE 300MM X 7.6MM - BLACK	133
VCL-45S	3.8 LITRE TANK PUMP	19	X-CB28-W-B100	CABLE TIE BASE - 28MM SELF ADHESIVE - WHITE	133	X-CT480-13B-B100	CABLE TIE 480MM X 13MM - BLACK	133
VOMA-20S	1.9 LITRE TANK PUMP	19	X-CB90-1H2H	90 DEGREE BRACKET - L HOLE/ 2 HOLE	120	X-CT730-13B-B100	CABLE TIE 730MM X 13MM - BLACK	133
VOMX-20S	1.4 LITRE TANK PUMP	19	X-CB90-1HLH	90 DEGREE BRACKET - L HOLE/ L HOLE	120	X-CTH-PG	CABLE TRAY COUPLER - MEDIUM DUTY	123
VCR-1	CORE REMOVAL TOOL & STORER ACCESS FITTING	49,74	X-CB90-2H2H	90 DEGREE BRACKET - 2 HOLE/ 2 HOLE	120	X-CTH-PG-100	CABLE TRAY HANGER - PRE-GALV. - 100MM	123
VCR-T-1	CORE REMOVAL TOOL ACCESS FITTING	49	X-CBC-1	CHANNEL CLAMP	120	X-CTH-PG-150	CABLE TRAY HANGER - PRE-GALV. - 150MM	123
VCRT-1	CORE REMOVAL TOOL	74	X-CBC-2	CHANNEL CLAMP	120	X-CTH-PG-225	CABLE TRAY HANGER - PRE-GALV. - 225MM	123
VCRT-1R	REPLACEMENT ROD ASSEMBLY	74	X-CBC-3	CHANNEL CLAMP	120	X-CTH-PG-300	CABLE TRAY HANGER - PRE-GALV. - 300MM	123
VCRT-1S	REPLACEMENT SHUT-OFF STEM	74	X-CBC-4	CHANNEL CLAMP	120	X-CTH-PG-50	CABLE TRAY HANGER - PRE-GALV. - 50MM	123
VIBA-1-1/8	VIBRATION ABSORBER 1-1/8 (28MM)	7	X-CBC-5	CHANNEL CLAMP	120	X-CTH-PG-75	CABLE TRAY HANGER - PRE-GALV. - 75MM	123
VIBA-1-3/8	VIBRATION ABSORBER 1-3/8 (35MM)	7	X-CBC-6	CHANNEL CLAMP	120	X-CT100-2.5B-B100	CABLE TIE 100MM X 2.52MM - BLACK	133
VIBA-1-5/8	VIBRATION ABSORBER 1-5/8 (42MM)	7	X-CBC-8	CHANNEL CLAMP	120	X-CTMD-B-100	CABLE TRAY FLAT BEND - 100MM	122
VIBA-1/2	VIBRATION ABSORBER 1/2 (12MM)	7	X-CBU-4121	CHANNEL U BRACKET - 41MM X 21MM	121	X-CTMD-B-150	CABLE TRAY FLAT BEND - 150MM	122
VIBA-1/4	VIBRATION ABSORBER 1/4 (6MM)	7	X-CBU-4141	CHANNEL U BRACKET - 41MM X 41MM	121	X-CTMD-B-225	CABLE TRAY FLAT BEND - 225MM	122
VIBA-2-1/8	VIBRATION ABSORBER 2-1/8 (54MM)	7	X-CBU-4162	CHANNEL U BRACKET - 41MM X 62MM	121	X-CTMD-B-300	CABLE TRAY FLAT BEND - 300MM	122
VIBA-2-5/8	VIBRATION ABSORBER 2-5/8 (64MM)	7	X-CEC4H-4121	CHANNEL 4-HOLE EXTERNAL CONNECTOR	121	X-CTMD-B-450	CABLE TRAY FLAT BEND - 450MM	122
VIBA-3-1/8	VIBRATION ABSORBER 3-1/8 (76MM)	7	X-CEC4H-4141	CHANNEL 4-HOLE EXTERNAL CONNECTOR	121	X-CTMD-B-50	CABLE TRAY FLAT BEND - 50MM	122
VIBA-3-5/8	VIBRATION ABSORBER 3-5/8 (89MM)	7	X-CH-1A-45135	CHANNEL INTERNAL ANGLE - 45 DEGREE 135	120	X-CTMD-B-75	CABLE TRAY FLAT BEND - 75MM	122
VIBA-3/4	VIBRATION ABSORBER 3/4 (18MM)	7	X-CH-4-IS	CHANNEL 4 WAY INTERSECTION	120	X-CTMD-FB-100	CABLE TRAY FLAT BEND - 100MM	122
VIBA-3/8	VIBRATION ABSORBER 3/8 (10MM)	7	X-CH-A	CHANNEL OFFSET - 45 DEGREE	120	X-CTMD-FB-150	CABLE TRAY FLAT BEND - 150MM	122
VIBA-4-1/8	VIBRATION ABSORBER 4-1/8 (108MM)	7	X-CH-LA-45	CHANNEL INTERNAL ANGLE - 45 DEGREE	120	X-CTMD-FB-225	CABLE TRAY FLAT BEND - 225MM	122
VIBA-5/8	VIBRATION ABSORBER 5/8 (17.6MM)	7	X-CH4121-2.5-3M	SLOTTED CHANNEL - 41MM X 21MM X 2.5MM	120	X-CTMD-FB-300	CABLE TRAY FLAT BEND - 300MM	122
VIBA-7/8	VIBRATION ABSORBER 7/8 (22MM)	7	X-CH4121-2.5-6M	SLOTTED CHANNEL - 41MM X 21MM X 2.5MM	120	X-CTMD-FB-450	CABLE TRAY FLAT BEND - 450MM	122
VS-4	ACCESS FITTING - FEMALE FLARE ACCESS FITTING	49	X-CH4121-L-5-3M	SLOTTED CHANNEL - 41MM X 21MM X 1.5MM	120	X-CTMD-FB-50	CABLE TRAY FLAT BEND - 50MM	122
VST-4	SWIVEL TEE 1/4 ACCESS FITTING	49	X-CH4121-L-5-6M	SLOTTED CHANNEL - 41MM X 21MM X 1.5MM	120	X-CTMD-FB-75	CABLE TRAY FLAT BEND - 75MM	122
VST-44	SWIVEL TEE 1/4 ACCESS FITTING	49	X-CH4141-2.5-3M	SLOTTED CHANNEL - 41MM X 41MM X 2.5MM	120	X-CTMD-IS-100	CABLE TRAY INTERSECTION - 100MM	123
VST-44X	SWIVEL TEE 1/4 WITH DEPRESSOR ACCESS FITTING	49	X-CH4141-L-5-3M	SLOTTED CHANNEL - 41MM X 41MM X 1.5MM	120	X-CTMD-IS-150	CABLE TRAY INTERSECTION - 150MM	123
VST-4X	SWIVEL TEE 1/4 WITH DEPRESSOR ACCESS FITTING	49	X-CH4141-L-5-6M	SLOTTED CHANNEL - 41MM X 41MM X 1.5MM	120	X-CTMD-IS-225	CABLE TRAY INTERSECTION - 225MM	123
VT-14	CLEAR 1/4" X 30 METRES CLEAR VINYL HOSE	24	X-CH4182-2.5-3M	SLOTTED CHANNEL - 41MM X 82MM X 2.5MM	120	X-CTMD-IS-300	CABLE TRAY INTERSECTION - 300MM	123
VT-38	CLEAR 3/8" X 30 METRES CLEAR VINYL HOSE	24	X-CH4182-2.5-6M	SLOTTED CHANNEL - 41MM X 82MM X 2.5MM	120	X-CTMD-IS-450	CABLE TRAY INTERSECTION - 450MM	123
VTR-24	THREADED TEE FITTING ACCESS FITTING	49	X-CH4L 4L-2.5-6M	SLOTTED CHANNEL - 41MM X 41MM X 2.5MM	120	X-CTMD-IS-75	CABLE TRAY INTERSECTION - 75MM	123
VTS-10	SOLDER TEE FITTING ACCESS FITTING	49	X-CHBC-3M	CHANNEL BLACK CAPPING - 3 METRES	120	X-CTMD-PG-100-3M	CABLE TRAY - MEDIUM DUTY PRE GALV.	122
VTS-46	SOLDER TEE FITTING ACCESS FITTING	49	X-CHBP2W-4141	CHANNEL BASE PLATE - TWO WAY	120	X-CTMD-PG-225-3M	CABLE TRAY - MEDIUM DUTY PRE GALV.	122
VTS-68	SOLDER TEE FITTING ACCESS FITTING	49	X-CHBPLW-4141	CHANNEL BASE PLATE - ONE WAY	120	X-CTMD-PG-300-3M	CABLE TRAY - MEDIUM DUTY PRE GALV.	122
VTS-810	SOLDER TEE FITTING ACCESS FITTING	49	X-CHCB-4121	PLASTIC END CAPS - 41MM X 21MM	122	X-CTMD-PG-450-3M	CABLE TRAY - MEDIUM DUTY PRE GALV.	122

CODE	DESCRIPTION	PAGE	CODE	DESCRIPTION	PAGE	CODE	DESCRIPTION	PAGE
X-CTMD-PG-50-3M	CABLE TRAY - MEDIUM DUTY PRE GALV.	122	X-PVCU-1/4-TP	PVCU - T PIECE	94	X-SYL5-SC-50	CABLE 5 CORE 1.5MM	133
X-CTMD-PG-600-3M	CABLE TRAY - MEDIUM DUTY PRE GALV.	122	X-PVCU-1/4E-45	PVCU - ELBOW - 45 DEGREE	94	X-TBR4H	T BRACKET - 4-HOLE	121
X-CTMD-PG-75-3M	CABLE TRAY - MEDIUM DUTY PRE GALV.	122	X-PVCU-1/4E-90	PVCU - ELBOW - 90 DEGREE	94	X-TBR4H-90	T BRACKET - 4-HOLE - 90 DEGREE	121
X-CTMD-PG-L 50-3M	CABLE TRAY - MEDIUM DUTY PRE GALV.	122	X-PVCU-1-HAC	PVCU - MACLOW CLIPS	94	X-TEK-MAGBIT	5/16 MAGNETIC SOCKET ADAPTOR	127
X-CTMD-R-150100	CABLE TRAY REDUCER - 150MM X 100MM	123	X-PVCU-1-SOCKET	PVCU - SOCKET	94	X-TEK5.5-25-B100	TEK SCREW 5.5 X 25MM	127
X-CTMD-R-225150	CABLE TRAY REDUCER - 225MM X 150MM	123	X-PVCU-1E-90	PVCU - ELBOW - 90 DEGREE	94	X-TEK5.5-38-B100	TEK SCREW 5.5 X 38MM	127
X-CTMD-R-300150	CABLE TRAY REDUCER - 300MM X 150MM	123	X-PVCU-1P-3M	PVCU - PIPE - 3 METRE LENGTH	94	X-TF10-1	TWIN FAST SCREW SIZE 10	127
X-CTMD-R-300225	CABLE TRAY REDUCER - 300MM X 225MM	123	X-PVCU-1TP	PVCU - T PIECE	94	X-TF10-1/2	TWIN FAST SCREW SIZE 10	127
X-CTMD-R-450300	CABLE TRAY REDUCER - 450MM X 300MM	123	X-PVCU-3/4-45T	PVCU - 45 DEGREE T	94	X-TF10-2	TWIN FAST SCREW SIZE 10	127
X-CTMD-R-600450	CABLE TRAY REDUCER - 600MM X 450MM	123	X-PVCU-3/4-CAP	PVCU - THREADED CAP	94	X-TF10-2-1/2	TWIN FAST SCREW SIZE 10	127
X-CTMD-SOB-100	CABLE TRAY STAND OFF BRACKET MEDIUM DUTY	123	X-PVCU-3/4-EC	PVCU - END CAP	94	X-TF8-1	TWIN FAST SCREW SIZE 8	127
X-CTMD-SOB-150	CABLE TRAY STAND OFF BRACKET MEDIUM DUTY	123	X-PVCU-3/4-MAC	PVCU - MACLOW CLIPS	94	X-TF8-1/2	TWIN FAST SCREW SIZE 8	127
X-CTMD-SOB-225	CABLE TRAY STAND OFF BRACKET MEDIUM DUTY	123	X-PVCU-3/4-PIN	PVCU - PIN / BARREL	94	X-TF8-2	TWIN FAST SCREW SIZE 8	127
X-CTMD-SOB-300	CABLE TRAY STAND OFF BRACKET MEDIUM DUTY	123	X-PVCU-3/4-R	PVCU - REDUCER	94	X-TR-M10-3M	THREADED ROD - 3M LENGTH	122
X-CTMD-SOB-450	CABLE TRAY STAND OFF BRACKET MEDIUM DUTY	123	X-PVCU-3/4-RE	PVCU - RODDING EYE	94	X-TR-M12-3M	THREADED ROD - 3M LENGTH	122
X-CTMD-SOB-75	CABLE TRAY STAND OFF BRACKET MEDIUM DUTY	123	X-PVCU-3/4-SOC	PVCU - SOCKET	94	X-TR-M6-3M	THREADED ROD - 3M LENGTH	122
X-CTMD-TP-100	CABLE TRAY TEE - 100MM	122	X-PVCU-3/4-TP	PVCU - T PIECE	94	X-TR-M8-3M	THREADED ROD - 3M LENGTH	122
X-CTMD-TP-150	CABLE TRAY TEE - 150MM	122	X-PVCU-3/4E-45	PVCU - ELBOW - 45 DEGREE	94	X-WA-M10-B100	FLAT / FORM A WASHER	125
X-CTMD-TP-225	CABLE TRAY TEE - 225MM	122	X-PVCU-3/4E-90	PVCU - ELBOW - 90 DEGREE	94	X-WA-M12-B100	FLAT / FORM A WASHER	125
X-CTMD-TP-300	CABLE TRAY TEE - 300MM	122	X-PVCU-3/4P-3M	PVCU - PIPE - 3 METRE LENGTH	94	X-WA-M6-B100	FLAT / FORM A WASHER	125
X-CTMD-TP-450	CABLE TRAY TEE - 450MM	122	X-PVCU-SOBSC-110MM	STRAP ON BOSS - 110MM PVCU	94	X-WA-M8-B100	FLAT / FORM A WASHER	125
X-CTMD-TP-75	CABLE TRAY TEE - 75MM	122	X-RBN-M10-20-B100	ROOFING NUT AND BOLT	126	X-WA10-30-B100	PENNY WASHER 30MM	125
X-CWB-4121	WINDOW BRACKET - 41MM X 21MM	121	X-RBN-M10-20-B20	ROOFING NUT AND BOLT	126	X-WA12-25-B100	PENNY WASHER 25MM	125
X-CWB-4141	WINDOW BRACKET - 41MM X 41MM	121	X-RBN-M6-12-B100	ROOFING NUT AND BOLT	126	X-WA12-25-B25	PENNY WASHER 25MM	125
X-CWB-4182	WINDOW BRACKET - 41MM X 82MM	121	X-RBN-M6-12-B20	ROOFING NUT AND BOLT	126	X-WA12-30-B100	PENNY WASHER 30MM	125
X-CYL0.75C-20-50	CABLE 2 CORE 0.75MM	133	X-RBN-M8-16-B100	ROOFING NUT AND BOLT	126	X-WA12-40-B100	PENNY WASHER 40MM	125
X-CYL1.2C-100	CABLE 2 CORE 1MM	133	X-RBN-M8-16-B20	ROOFING NUT AND BOLT	126	X-WA6-25-B100	PENNY WASHER 25MM	125
X-CYL1.5-2C-100	CABLE 2 CORE 1.5MM	133	X-SS12-25-B10	HEX SET 25MM	127	X-WA6-25-B25	PENNY WASHER 25MM	125
X-CYL-2C-50	CABLE 2 CORE 1MM	133	X-SS12-25-B100	HEX SET 25MM	127	X-WA6-30-B100	PENNY WASHER 30MM	125
X-CYL-5-2C-50	CABLE 2 CORE 1.5MM	133	X-SS12-30-B10	HEX SET 30MM	127	X-WA6-40-B100	PENNY WASHER 40MM	125
X-DIA-M10-B10	DROP IN ANCHOR	129	X-SS12-30-B100	HEX SET 30MM	127	X-WA6-40-B100	PENNY WASHER 40MM	125
X-DIA-M10-B50	DROP IN ANCHOR	129	X-SB810-B4	SOCKET BOLT MB-ML0	128	X-WA6-30-B100	PENNY WASHER 30MM	125
X-DIA-M12-B10	DROP IN ANCHOR	129	X-SBB10-B100	SOCKET BOLT MB-ML0	128	X-WA6-40-B100	PENNY WASHER 40MM	125
X-DIA-M12-B50	DROP IN ANCHOR	129	X-SBL-810-35-B50	SOCKET BOLT LOOSE M8-M10 (3 PIECE) 35MM	128	X-WA6-30-B100	PENNY WASHER 30MM	125
X-DIA-M8-B10	DROP IN ANCHOR	129	X-SBL-810-55-B50	SOCKET BOLT LOOSE M8-M10 (3 PIECE) 55MM	128	X-WA6-40-B100	PENNY WASHER 40MM	125
X-DIA-M8-B100	DROP IN ANCHOR	129	X-SBL2810-B100	SOCKET BOLT LOOSE M8-ML0 (2 PIECE)	128	X-WA6-25-B100	PENNY WASHER 25MM	125
X-DIA-ST	DROP IN ANCHOR SETTING TOOL	129	X-SBL810-B100	SOCKET BOLT LOOSE MB-ML0 (3 PIECE)	128	X-WAS-25-B25	PENNY WASHER 25MM	125
X-DIAL-M10-B50	DROP IN ANCHOR LIPPED	129	X-SBL810-B4	SOCKET BOLT LOOSE MB-ML0 (3 PIECE)	128	X-WF0.75-2C-50	CABLE 2 CORE 0.75MM	133
X-DIAL-M12-B50	DROP IN ANCHOR LIPPED	129	X-SCA-M10	STUDDING CAPS	122	X-WF0.75-3C-50	CABLE 3 CORE 0.75MM	133
X-DIAL-M8-B100	DROP IN ANCHOR LIPPED	129	X-SCA-M10-B30	STUDDING CAPS	122	X-WF1-2C-100	CABLE 2 CORE 1MM	133
X-DPSW-20A	SWITCH DOUBLE POLE - 20 AMP	89, 132	X-SCA-M12	STUDDING CAPS	122	X-WF1-2C-50	CABLE 2 CORE 1MM	133
X-EB-MB-B25	EYE BOLT - MB X 80MM	128	X-SCA-M12-B30	STUDDING CAPS	122	X-WF1-3C-50	CABLE 3 CORE 1MM	133
X-EB-ML0-B10	EYE BOLT - ML OX 80MM	128	X-SCA-M6	STUDDING CAPS	122	X-WF2.5-3C-50	CABLE 3 CORE 2.5MM	133
X-FP2H	FLAT PLATE	121	X-SCA-M6-B30	STUDDING CAPS	122	X-WFL-5-3C-50	CABLE 3 CORE 1.5MM	133
X-FP3H	FLAT PLATE	121	X-SCA-M8	STUDDING CAPS	122	X-WN-M10-B100	WEDGE NUTS	126
X-FP3H-90	FLAT PLATE - 3-HOLE - 90 DEGREE	121	X-SCA-M8-B30	STUDDING CAPS	122	X-WN-M12-B100	WEDGE NUTS	126
X-FP4H	FLAT PLATE	121	X-SCON-M10-B100	STUD CONNECTOR	127	X-WN-M6-B100	WEDGE NUTS	126
X-FP5H	FLAT PLATE	121	X-SCON-M10-B4	STUD CONNECTOR	127	X-WN-M8-B100	WEDGE NUTS	126
X-FS	FUSED SPUR PLASTIC - WITHOUT NEON	89, 132	X-SCON-M8-B100	STUD CONNECTOR	127	X-WPB-7MM	WALL PLUG 7MM - BROWN	127
X-FSBBMC	FUSED SPUR METAL CLAD - WITH BACK BOX	89, 132	X-SCON-M8-B4	STUD CONNECTOR	127	X-WPG-8/10MM	WALL PLUG 8/10MM - GREY	127
X-FSN	FUSED SPUR PLASTIC - WITH NEON	89, 132	X-SOLCEM	SOLVENT CEMENT	93	X-WPR-5MM	WALL PLUG 5MM - RED	127
X-FSNBMC	FUSED SPUR METAL CLAD	89, 132	X-SPW-M10-B100	SHAKE PROOF WASHER	125	X-YY0.75-4C-100	CABLE 4 CORE 0.75MM	133
X-HN-M10-B100	HEXAGONAL NUT	126	X-SPW-M12-B100	SHAKE PROOF WASHER	125	X-YY0.75-4C-50	CABLE 4 CORE 0.75MM	133
X-HN-M10-B25	HEXAGONAL NUT	126	X-SPW-M6-B100	SHAKE PROOF WASHER	125	X-YY1.5-7C-50	CABLE 7 CORE 1.5MM	133
X-HN-M12-B100	HEXAGONAL NUT	126	X-SPW-M8-B100	SHAKE PROOF WASHER	125	X-YY2.5-3C-100	CABLE 3 CORE 2.5MM	133
X-HN-M12-B25	HEXAGONAL NUT	126	X-SQPW-M6-B6	SQUARE PLATE WASHER	125	X-YY2.5-4C-100	CABLE 4 CORE 2.5MM	133
X-HN-M6-B100	HEXAGONAL NUT	126	X-SQPW-M6-BL00	SQUARE PLATE WASHER	125	X-YY2.5-4C-50	CABLE 4 CORE 2.5MM	133
X-HN-M6-B25	HEXAGONAL NUT	126	X-SQPW-M8-B6	SQUARE PLATE WASHER	125	X-YYL-5-2C-100	CABLE 2 CORE 1.5MM	133
X-HN-M8-B100	HEXAGONAL NUT	126	X-SQPW-M8-BL00	SQUARE PLATE WASHER	125	X-YYL-5-4C-100	CABLE 4 CORE 1.5MM	133
X-HN-M8-B25	HEXAGONAL NUT	126	X-SQPW-ML2-B6	SQUARE PLATE WASHER	125	X-YYL-5-4C-50	CABLE 4 CORE 1.5MM	133
X-HNC-M10-B100	HEXAGONAL NUT COVER	126	X-SQPW-ML2-BL00	SQUARE PLATE WASHER	125	X-YYL-5-7C-100	CABLE 7 CORE 1.5MM	133
X-HNC-M8-B100	HEXAGONAL NUT COVER	126	X-SS10-30-B10	HEX SET 30MM	127	X-SQPW-ML0-B6	SQUARE PLATE WASHER	125
X-LBSA-0810L	LOOSE BOLT SHIELD ANCHOR - 0810L	128	X-SS10-30-B100	HEX SET 30MM	127	X-SQPW-ML0-BL00	SQUARE PLATE WASHER	125
X-LBSA-1025L	LOOSE BOLT SHIELD ANCHOR - 1025L	128	X-SS10-35-B10	HEX SET 35MM	127			
X-LBSA-1010L	LOOSE BOLT SHIELD ANCHOR - 1010L	128	X-SS10-35-B100	HEX SET 35MM	127			
X-PBS	PLASTER BOARD SCREW 15MM	127	X-SS10-40-B100	HEX SET 40MM	127			
X-PC	PURLING CLIP Z10 BEAM CLAMP	121	X-SS10-50-B10	HEX SET 50MM	127			
X-PC-M10	PURLING CLIP - PULL ON - M10	121	X-SS10-50-B100	HEX SET 50MM	127			
X-PC-M8	PURLING CLIP - PULL ON - M8	121	X-SS12-40-B10	HEX SET 40MM	127			
X-PCU-108-116	PIPE CLAMP UNLINED - 108-116MM	129	X-SS12-40-BL00	HEX SET 40MM	127			
X-PCU-15-18	PIPE CLAMP UNLINED - 15-18MM	129	X-SS6-30-B10	HEX SET 30MM	127			
X-PCU-20-25	PIPE CLAMP UNLINED - 20-25MM	129	X-SS6-30-B100	HEX SET 30MM	127			
X-PCU-26-30	PIPE CLAMP UNLINED - 26-30MM	129	X-SS8-30-B10	HEX SET 30MM	127			
X-PCU-32-36	PIPE CLAMP UNLINED - 32-36MM	129	X-SS8-30-B100	HEX SET 30MM	127			
X-PCU-38-43	PIPE CLAMP UNLINED - 38-43MM	129	X-SS8-40-B10	HEX SET 40MM	127			
X-PCU-44-49	PIPE CLAMP UNLINED - 44-49MM	129	X-SS8-40-B100	HEX SET 40MM	127			
X-PCU-56-61	PIPE CLAMP UNLINED - 56-61MM	129	X-SS8-50-B10	HEX SET 50MM	127			
X-PCU-75-80	PIPE CLAMP UNLINED - 75-80MM	129	X-SS8-50-B100	HEX SET 50MM	127			
X-PCU-87-92	PIPE CLAMP UNLINED - 87-92MM	129	X-SV1-4C-100	CABLE 4 CORE 1MM	133			
X-PT	PLUG TOP - 13 AMP	89, 132	X-SV1.5-3C-100	CABLE 3 CORE 1.5MM	133			
X-PVCU-1/4-3M	PVCU - PIPE - 3 METRE LENGTH	94	X-SV1.5-4C-100	CABLE 4 CORE 1.5MM	133			
X-PVCU-1/4-45T	PVCU - 45 DEGREE T	94	X-SV1.5-4C-50	CABLE 4 CORE 1.5MM	133			
X-PVCU-1/4-CAP	PVCU - THREADED CAP	94	X-SV2.5-3C-100	CABLE 3 CORE 2.5MM	133			
X-PVCU-1/4-MAC	PVCU - MACLOW CLIPS	94	X-SV2.5-3C-50	CABLE 3 CORE 2.5MM	133			
X-PVCU-1/4-PIN	PVCU - PIN / BARREL	94	X-SV2.5-4C-100	CABLE 4 CORE 2.5MM	133			
X-PVCU-1/4-R	PVCU - REDUCER	94	X-SV2.5-5C-100	CABLE 5 CORE 2.5MM	133			
X-PVCU-1/4-RE	PVCU - RODDING EYE	94	X-SV2.5-5C-50	CABLE 5 CORE 2.5MM	133			
X-PVCU-1/4-SOC	PVCU - SOCKET	94	X-SYL5-SC-100	CABLE 5 CORE 1.5MM	133			

ENGINEER ON CALL

TELEPHONE



DiversiTech International Ltd.
Glaisdale Drive East Nottingham NG8 4LY United Kingdom
T: +44(0)115 900 5858 E: sales@diversitech.com W: www.diversitech.global

